

Printed at the Mathematical Centre, 413 Kruislaan, Amsterdam.

The Mathematical Centre, founded the 11-th of February 1946, is a non-profit institution aiming at the promotion of pure mathematics and its applications. It is sponsored by the Netherlands Government through the Netherlands Organization for the Advancement of Pure Research (Z.W.O.).

MC SYLLABUS 28

**O. DIEKMANN
N.M. TEMME (EDS)**

**NONLINEAR
DIFFUSION PROBLEMS**

SECOND PRINTING

MATHEMATISCH CENTRUM AMSTERDAM 1982

AMS(MOS) Subject classification scheme (1970) : 35-02,35BXX,35K55,34C35,92A05,92A10

ISBN 90 6196 126 2

First printing: 1976

Second printing: 1982

CONTENTS

<i>Introduction</i>	<i>vi</i>
I. MODELS AND METHODS: A FIRST IMPRESSION	1
II. EXISTENCE AND UNIQUENESS OF ONE-DIMENSIONAL NONLINEAR PARABOLIC EQUATIONS	26
III. MONOTONE ITERATION	61
IV. TRAVELLING FRONTS	84
V. EXAMINATION OF STABILITY BY MEANS OF LYAPUNOV FUNCTIONS	136
VI. MATHEMATICAL ASPECTS OF A MODEL CHEMICAL REACTION WITH DIFFUSION	165
VII. NERVE AXON EQUATIONS	233
REFERENCES	243
GENERAL INDEX	245

INTRODUCTION

In the first half of 1976, the department of Applied Mathematics of the Mathematical Centre organized a colloquium on Nonlinear Diffusion Problems under supervision of H. A. Lauwerier and L.A. Peletier. This book contains the proceedings of the lectures of that colloquium.

At the moment many papers about nonlinear diffusion problems are appearing in the literature. The idea of the colloquium was to present background material on the qualitative analysis of parabolic partial differential equations in such a way that the existing and forthcoming literature was made accessible to the audience. Theoretical methods were presented and, whenever possible, their use was demonstrated in the analysis of some prototype problem. Most of these prototype problems arise as mathematical models of a biological phenomenon and the mathematical questions are motivated by these models. This is a reflection of the fact that quite often the research in this area is inspired by biological applications.

In Chapter I, first a brief indication of the biological background of some mathematical questions is presented and subsequently the use of the variational method of proving existence of equilibria and the Lyapunov method of proving stability are demonstrated.

Chapter II contains basic results on existence and uniqueness of solutions of the initial-boundary value problem for a one-dimensional nonlinear parabolic equation. Moreover the maximum principle is introduced.

The maximum principle is used extensively in Chapter III. It is shown how upper and lower solutions yield monotone iteration schemes and how in this way one can get information concerning existence, nonexistence and stability of equilibria.

Chapter IV is devoted to travelling wave solutions (i.e., solutions of the form $u(x,t) = w(x-ct)$ of the one-dimensional equation $u_t = u_{xx} + f(u)$, $-\infty < x < \infty$). Phase plane methods are used to show existence and the maximum principle and Lyapunov functions to obtain results concerning stability.

In Chapter V the basic theory of Lyapunov functions for dynamical systems is presented and subsequently it is shown how this theory can be applied to parabolic initial-boundary value problems (again in the case of one space-variable).

The last two chapters deal with systems of nonlinear diffusion equations. In Chapter VI the system resulting from a model chemical reaction, as proposed, by Prigogine is discussed. The existence for all time of a solution of the initial-boundary value problem is proved by means of the Faedo-Galerkin method. Then, following the general lines of bifurcation theory, the existence and stability of equilibria (and of periodic solutions) is discussed by analyzing their dependence on a parameter.

Finally, in Chapter VII an indication is given of the questions, results and techniques occurring in the rapidly increasing mathematical literature inspired by the Hodgkin-Huxley theory of the propagation of an electrical impulse along a nerve axon.

The results in this book are not new. Apart from minor details all of the contents can be found in the literature. However, it is hoped that for everybody who is interested in the subject, this book can serve as a useful and quick introduction.

The lectures were prepared in working groups and every member of our department has contributed to the success of the colloquium.

The lectures were given by

O. DIEKMANN	Chapter I
J.W. de ROEVER	Chapter II
I.G. SPRINKHUIZEN-KUYPER	Chapter III
B. DIJKHUIS	Chapter IV 1-3
E.J.M. VELING	Chapter IV 4-5
T.H. KOORNWINDER	Chapter V
T.M.T. COOLEN	Chapter VI 1-9
J. GRASMAN	Chapter VI 10-15
E.J.M. VELING	Chapter VII

They also are the authors of the corresponding parts of the text. For Chapter IV 1-3, O. Diekmann and E.J.M. Veling were co-authors. The pictures were made by G.J.M. Laan. In the selection of the material the guidance of L.A. Peletier was very helpful.

I. MODELS AND METHODS: A FIRST IMPRESSION

1. INTRODUCTION

A frequent approach in applied mathematics is to study prototype problems in full detail. In doing so, one hopes to get examples of both the qualitative behaviour of solutions of a whole class of problems, and the use of analytical tools in a specific case.

For linear partial differential equations there is the classification into equations of elliptic, parabolic and hyperbolic type, and each type has its classical representative (the equation of Laplace, the heat equation and the wave equation). The study of these equations has resulted in a clear view of the behaviour of their solutions, and this in turn has led to an understanding of the physical processes that are modelled by the equations.

The diversity of phenomena that one can expect in the field of nonlinear partial differential equations is much larger (for example, the important property of superposition of solutions is lost). Accordingly, there will be a lot of prototype problems, but unfortunately one does not always know in advance which problems deserve this qualification.

In this series of lectures a number of nonlinear diffusion problems will be discussed which have had much attention in the recent mathematical literature, and which are likely to remain in the center of interest for some time to come. Some of the problems are mathematical models of phenomena from the natural sciences (in fact biology), and some are reduced forms of such models. The objective is to analyze equations which are as simple as possible and yet show the most important qualitative features.

It is hoped that the meaning of "nonlinear diffusion problem" is intuitively clear and we will not try to define it (we would certainly get entangled). Moreover, we emphasize that there are a lot of nonlinear diffusion problems which are rather different from the ones that will be dealt with here (for examples we refer to [1]).

In the next three sections of this first chapter we will give a brief indication of the biological background of the mathematical questions. In the remaining sections one of the problems is worked out and the use of general methods is demonstrated.

2. CONDUCTION OF A NERVE IMPULSE

How is information transmitted through the nervous system? Experimentally it is observed that electrical impulses travel along individual nerve cells. These impulses have the form shown in Figure 1 and they are propagated with *constant velocity*.

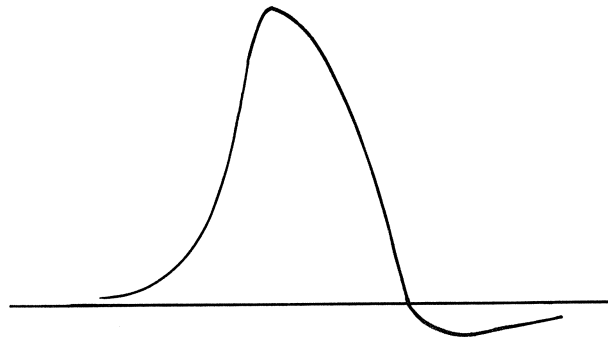

Figure 1

Hodgkin and Huxley developed a theoretical model which can be formulated mathematically as:

$$(2.1) \quad \begin{aligned} u_{xx} &= u_t + I(u,w), & -\infty < x < \infty, \quad 0 < t < \infty, \\ w_t &= P(u)w + q(u), \end{aligned}$$

where subscripts denote partial differentiation. Here $u(x,t)$ denotes the electrical potential across the membrane that surrounds the (infinitely long, cylindrical) nerve cell and $w(x,t)$ is a three-dimensional vector which describes the permeability of the membrane to certain ions. I , P and q are given functions (some of the functional dependence on u and w is more or less assumed ad hoc, since the molecular structure of the membrane is not completely known).

The equations (2.1) are very complicated and there is not much hope of a useful analytical treatment. The results of extensive numerical studies are in good agreement with the experiments, but one way or another computer simulation on its own is not fully satisfactory. The phenomenon of a so-called *travelling wave solution* (i.e., a solution depending only on the single variable $\xi = x + ct$, where $c \neq 0$ is constant) is not observed for linear parabolic partial differential equations (although of course the un-

bounded function $u = \exp\{c(x+ct)\}$ satisfies $u_t = u_{xx}$, irrespective of the value of c . The "jump" from the analytical theory of linear equations to numerical analysis of (2.1) is too large, and one needs an intermediary in the form of a simplification of (2.1) for which one can show analytically that there are travelling wave solutions which resemble the nerve impulse.

The simplified model

$$(2.2) \quad \begin{aligned} u_{xx} &= u_t - u(1-u)(u-a) + \varepsilon w, \\ w_t &= u, \end{aligned} \quad 0 < a < 1, \quad \varepsilon > 0,$$

has been formed by NAGUMO, ARIMOTO and YOSHIZAWA [2] after the preparatory work of FITZHUGH [3]. How can one show that (2.2) admits a travelling wave solution which looks like Figure 1? Substitution of $u = u(x+ct)$, $w = w(x+ct)$ into (2.2) yields a system of ordinary differential equations depending upon the parameter c ,

$$(2.3) \quad \begin{aligned} u' &= v, \\ v' &= cv - u(1-u)(u-a) + \varepsilon w, \\ w' &= c^{-1}u, \end{aligned}$$

and the problem is to find values of c such that (2.3) has a nonconstant solution with $u(\pm\infty) = 0$. In other words, one is looking for values of c such that (2.3) has an orbit beginning and ending at the equilibrium point $(0,0,0)$ (a so-called homoclinic trajectory). It is clear that the nonlinearity of the problem is essential for the existence of such an orbit.

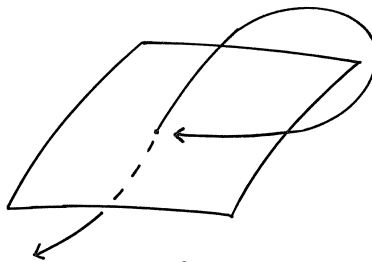

Figure 2

We see that a concrete mathematical model of a neurobiological phenomenon leads to a quite general and difficult mathematical question concerning the existence of a homoclinic trajectory for a system of ordinary differential equations depending on a parameter. In Chapter VII much more will be said about this sort of problem.

In this section we have only touched on some of the mathematical questions that are related to the Hodgkin-Huxley theory and we refer the interested reader to [1] and [4] and the references therein.

3. REACTION-DIFFUSION PROBLEMS AND MORPHOGENESIS

The evolution of a chemical system in which reaction and diffusion takes place is described by the system of equations

$$(3.1) \quad u_t = \Delta u + f(u).$$

Here $u = u(x,t)$ is an n -dimensional vector of concentrations of chemical species and f represents the source term generated by the chemical reactions.

TURING [5] studied equations like (3.1) and he showed that they can have stable space-dependent steady-state solutions, even when the boundary conditions suggest only uniform steady states. His idea is that one can "explain" morphogenesis (i.e., the generation of form and pattern in biological systems) as resulting from reaction and diffusion of chemical species. This kind of model building and explanation differs from the conventional method and therefore ROSEN [6] has proposed using the term *metaphor* instead of model.

A rapidly increasing amount of mathematical literature on reaction-diffusion problems is inspired by the spatial and temporal ordering in biological systems (see for example the first three chapters of [7]). Part of the effort is being directed towards a detailed analysis of a typical problem, or as NICOLIS [7] says: *In a way, we are looking for the "harmonic oscillator" or for the "Ising model" of nonlinear kinetics.* Chapter VI is devoted to this approach.

4. ADVANTAGEOUS GENES

If in a population a certain gene occurs in two forms, a and A , one can divide the individuals into three classes or genotypes (aa , aA and AA). Let us suppose that

- the population mates at random, producing offspring with a certain birth-rate r ;
- the deathrate τ depends on the genotype (think of differences in adaptation to the environment);
- the population diffuses through the habitat with diffusion constant one.

Then the densities ρ_1 , ρ_2 and ρ_3 of the genotypes aa , aA and AA respectively, satisfy

$$(4.1) \quad \begin{aligned} \frac{\partial \rho_1}{\partial t} &= \Delta \rho_1 - \tau_1 \rho_1 + \frac{r}{\rho} (\rho_1 + \frac{1}{2} \rho_2)^2, \\ \frac{\partial \rho_2}{\partial t} &= \Delta \rho_2 - \tau_2 \rho_2 + \frac{2r}{\rho} (\rho_1 + \frac{1}{2} \rho_2) (\rho_3 + \frac{1}{2} \rho_2), \\ \frac{\partial \rho_3}{\partial t} &= \Delta \rho_3 - \tau_3 \rho_3 + \frac{r}{\rho} (\rho_3 + \frac{1}{2} \rho_2)^2, \end{aligned}$$

where $\rho \equiv \rho_1 + \rho_2 + \rho_3$.

Most of the analytical work concerns the simplified model (see [8], [9] and [10])

$$(4.2) \quad u_t = \Delta u + f(u),$$

where $f(u) = u(1-u)\{(\tau_1 - \tau_2)(1-u) - (\tau_3 - \tau_2)u\}$ and $u = \rho^{-1}(\rho_3 + \frac{1}{2}\rho_2)$, the relative density. In the event that there is one space dimension, the results for equation (4.2) include the existence of travelling wave solutions corresponding to a heteroclinic trajectory (an orbit connecting two different equilibrium points of an ordinary differential equation). This material will be presented in Chapter IV.

One sometimes observes in nature that the frequency of the genotypes is a function of the geographical location, and one would like to show that this is reflected in the solutions of (4.2). Suppose the habitat to be a bounded one-dimensional region in which the population lives in isolation. This means that we impose at the end points the homogeneous Neumann boundary condition

$$(4.3) \quad u_x = 0.$$

The equilibrium solutions satisfy (4.3) and

$$(4.4) \quad u_{xx} + f(u) = 0.$$

From a plot of the trajectories of solutions of (4.4) in the phase plane (see Figure 3) it follows readily that space-dependent equilibrium solutions are quite well possible (see [11] for more details).

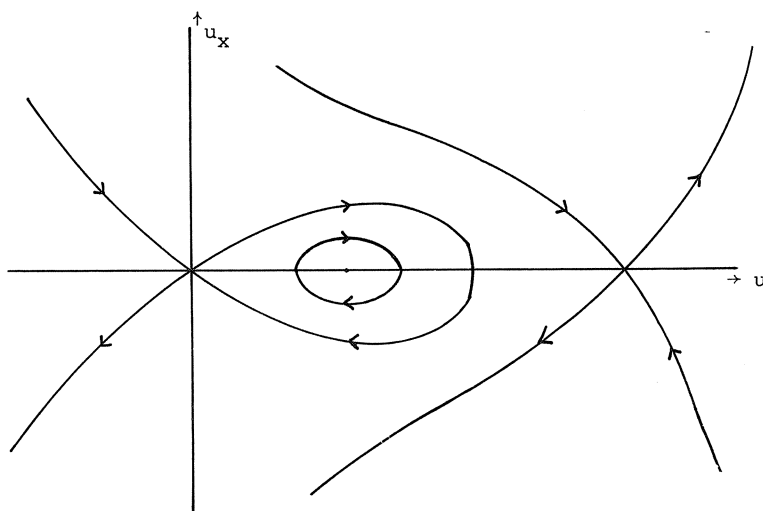

Figure 3

However, it has been proved by WILLEMS & HEMKER [11] that such equilibrium solutions are always unstable. In Chapter V another proof (in the style of CHAFEE [12]) of this remarkable fact will be given. This result partly motivates the analysis of yet another model problem in the next sections.

5. A MODEL INCORPORATING THE GEOGRAPHICAL SITUATION

The material in this and some of the following sections is based on a paper of FLEMING [13].

To the assumptions of Section 4 we add one more, namely that a selective advantage at some point of the habitat becomes a selective disadvantage at others. As an example of a responsible mechanism one may think of the colour of the soil in relation to the protective colouring of some sort of animal (differences being due to the gene). The mathematical formulation

takes the form

$$(5.1) \quad w_t = w_{xx} + \lambda g(x)f(w), \quad -1 < x < 1, \quad t > 0,$$

$$w_x(\pm 1, t) = 0,$$

where $f, g \in C^2$,

$$(5.2) \quad f(0) = f(1) = 0, \quad f(w) > 0 \quad \text{for } 0 < w < 1,$$

and g takes both positive and negative values on $[-1, 1]$.

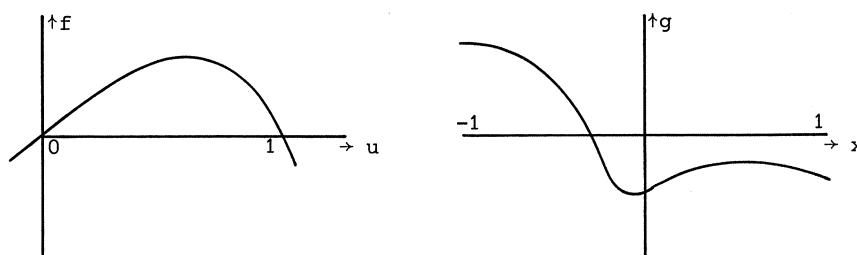

Figure 4

The positive parameter λ is characteristic for the ratio of the influence of selection and of diffusion.

We will study the dependence of equilibria on λ . As usual *equilibrium* means a function $u(x)$ satisfying

$$(5.3) \quad u_{xx} + \lambda g(x)f(u) = 0, \quad -1 < x < 1,$$

$$(5.4) \quad u_x(\pm 1) = 0,$$

and in addition, since u is supposed to be a frequency,

$$(5.5) \quad 0 \leq u \leq 1.$$

There are always (i.e., for all values of λ) two trivial equilibria

$$(5.6) \quad u^0(x) \equiv 0, \quad u^1(x) \equiv 1.$$

We are interested in the existence of space-dependent equilibria and in their stability, because only stable equilibria will be observed in nature. For discussing stability we have to look at the initial value problem. Suppose that for every ψ in an appropriate normed space X (with norm $\|\cdot\|$) the problem (5.1) supplemented with the initial condition

$$(5.7) \quad w(x,0) = \psi(x)$$

has a unique solution $w(x,t)$, belonging to X for every t . Then we call an equilibrium $u \in X$ *stable* if for every $\epsilon > 0$ there exists $\delta > 0$ such that

$$\|\psi - u\| < \delta \text{ implies } \|w(\cdot, t) - u\| < \epsilon \quad \text{for all } t \geq 0.$$

In the next sections a natural combination of the variational method and the Lyapunov stability method will enable us to obtain results concerning existence and stability almost simultaneously.

6. VARIATIONAL FORMULATION AND EXISTENCE OF A MINIMUM

In the analysis of the boundary value problem (5.3), (5.4), we will follow the standard Hilbert space approach as described in [14]. As usual, we let H^1 denote the (Sobolev) space that is obtained by completion of the space of C^∞ -functions with respect to the norm

$$\|u\| = \left(\int_{-1}^1 (u^2 + u_x^2) dx \right)^{\frac{1}{2}}.$$

The elements of H^1 can be characterized as L_2 -functions having a generalized derivative and, in the case of one variable, the following important theorem holds:

THEOREM 6.1. (SOBOLEV). H^1 is compactly imbedded in C^0 .

In other words, every $u \in H^1$ is equivalent to a continuous function, and every bounded set in H^1 has compact closure in C^0 . In particular it follows that out of every bounded sequence in H^1 one can extract a subsequence that converges in C^0 (i.e., with respect to the norm given by $\max_{-1 \leq x \leq 1} |u(x)|$). In Section II. 2 more general results are stated and, concerning the proof, a reference to the literature is given.

The problem (5.3), (5.4) can be given a variational formulation:

$$(6.1) \quad L_u(\phi) = 0, \quad \text{for every } \phi \in H^1,$$

where

$$(6.2) \quad L_u(\phi) = \int_{-1}^1 \{u_x \phi_x - \lambda g(x) f(u) \phi\} dx$$

and the unknown u is an element of H^1 .

It follows that we are looking for critical points of the functional $V: H^1 \rightarrow \mathbb{R}$ given by

$$(6.3) \quad V(u) = \int_{-1}^1 \{ \frac{1}{2} u_x^2 - \lambda g(x) F(u) \} dx,$$

where

$$(6.4) \quad F(u) = \int_0^u f(y) dy.$$

In the appendix we show that the boundary conditions are reflected in the fact that we are working in H^1 (and not as for the Dirichlet problem in H_0^1 ; see [14]). Henceforth, we shall use the word "equilibrium" for critical points of V as well. This is justified by a regularity proof in the appendix. A more classical formulation is that (5.3) is the Euler equation of (6.3) and (5.4) the free boundary condition.

THEOREM 6.2. *There exists an equilibrium u^* minimizing V on $X = \{u \in H^1 \mid 0 \leq u \leq 1\}$.*

PROOF. The proof uses standard variational arguments. For definitions of concepts and notation we refer to [14]. Write $V(u) = T(u) - \lambda B(u)$ where $T: H^1 \rightarrow \mathbb{R}$ and $B: H^1 \rightarrow \mathbb{R}$ are defined by

$$T(u) = \frac{1}{2} \int_{-1}^1 u_x^2 dx, \quad B(u) = \int_{-1}^1 g(x) F(u) dx.$$

Since T is weakly lower semi-continuous (see [14], p.150) and B is weakly continuous (if $u^n \rightharpoonup \tilde{u}$ in H^1 , then $u^n \rightarrow \tilde{u}$ in C^0 and thus $B(u^n) \rightarrow B(\tilde{u})$), we know that V is weakly lower semi-continuous. Because $V(u) \geq -\lambda B(u)$ and B is bounded on X , V is bounded from below on X . Let $\{u^n\} \subset X$ be such that $V(u^n) \rightarrow m = \inf\{V(u) \mid u \in X\}$. Since $\{V(u^n)\}$ is bounded $\{T(u^n)\}$ must

be bounded, and therefore $\{u^n\}$ is bounded in H^1 . Hence $\{u^n\}$ contains a weakly convergent subsequence $\{u^{n'}\}$, $u^{n'} \rightharpoonup u^*$ say. Then $u^* \in X$ and $V(u^*) = m$ by the weak lower semi-continuity of V .

It remains to show that u^* is a critical point. Since u^* does not need to be an interior point of X we cannot refer directly to the standard result that extreme points are critical points (Theorem 3.1.2 in [14]). We need a trick. Let

$$\tilde{F}(u) = \begin{cases} F(2-u), & 1 \leq u \leq 2, \\ F(u), & 0 \leq u \leq 1, \\ F(-u), & -1 \leq u \leq 0, \end{cases}$$

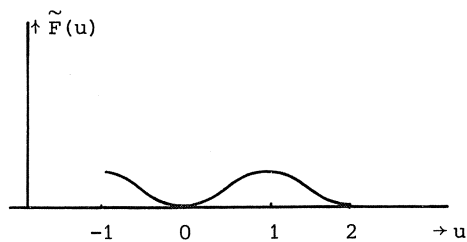

Figure 5

and let \tilde{V} be the corresponding functional. Since $f(0) = f(1) = 0$, \tilde{V} is Fréchet differentiable. Furthermore, u^* minimizes \tilde{V} among all $u \in H^1$ such that $-1 \leq u \leq 2$. We conclude that u^* must be a critical point of \tilde{V} and hence of V . \square

We would like to conclude from Theorem 6.2 the existence of a nontrivial equilibrium. A possible way is to calculate $V(u)$ for suitable chosen functions u (as soon as we find u for which $V(u) < V(u^0)$ and $V(u) < V(u^1)$ we are done). In Section 9 we will follow a more systematic approach, but the basic idea will be the same.

7. STABILITY OF EQUILIBRIA

In Chapter II the question of the existence and uniqueness of a solution for the initial boundary value problem (5.1), (5.7) will be treated.

Here we restrict ourselves to a statement of results in a convenient way.

For every $\psi \in H^1$ there exists a unique solution $w(x,t)$; $w(\cdot, t) \in H^1$ for all t and w has smoothness properties which justify the steps below

$$\begin{aligned} \frac{d}{dt} V(w(\cdot, t)) &= \lim_{\delta \downarrow 0} \int_{-1+\delta}^{1-\delta} \{w_x w_{xt} - \lambda g(x) f(w) w_t\} dx \\ &= - \int_{-1}^1 \{w_{xx} + \lambda g(x) f(w)\} w_t dx \\ &= - \int_{-1}^1 w_t^2 dx. \end{aligned}$$

The result $\frac{d}{dt} V(w(\cdot, t)) \leq 0$ shows that V can be used as a *Lyapunov functional*. The intuitive idea is that critical points are stable if and only if they correspond to (local) minima of V (for an introduction to the Lyapunov theory of stability we refer to [16]). The following theorem shows that u is indeed stable if V is minimal at u and a slight additional condition is satisfied.

THEOREM 7.1. *If there exists an $r > 0$ such that*

$$V(u+\phi) - V(u) \geq h(\|\phi\|) \quad \text{for all } \phi \text{ with } \|\phi\| < r,$$

where h is continuous, monotone increasing and $h(0) = 0$, then u is stable.

PROOF. Given ε , $0 < \varepsilon < r$, choose $\delta > 0$ such that $V(u+\phi) - V(u) \leq h(\varepsilon)$ for all ϕ with $\|\phi\| < \delta$ (since V is continuous, such a δ always exists). So, if ψ satisfies $\|\psi - u\| < \delta$, we have, as long as $\|w(\cdot, t) - u\| < r$,

$$h(\|w(\cdot, t) - u\|) \leq V(w(\cdot, t)) - V(u) \leq V(\psi) - V(u) \leq h(\varepsilon),$$

and thus $\|w(\cdot, t) - u\| < \varepsilon$. \square

An equilibrium u is called *unstable* if it is not stable and *asymptotically stable* if it is stable and in addition $\|w(\cdot, t) - u\| \rightarrow 0$ as $t \rightarrow \infty$ for all ψ with $\|\psi - u\|$ sufficiently small. It is possible to obtain results concerning instability and asymptotic stability by an approach that will be fully developed in Chapter V. Here we merely outline the reasoning.

In fact, $\frac{d}{dt} V(w(\cdot, t)) < 0$ for all $t \geq 0$ unless w is an equilibrium solution (V is a *strict* Lyapunov functional). From the maximum principle (see

Chapter II) it follows that $X = \{\phi \in H^1 \mid 0 \leq \phi \leq 1\}$ is invariant with respect to (5.1) (i.e., if $\psi \in X$, then $w(.,t) \in X$ for all t). $V(w(.,t))$, being decreasing and bounded from below on X , has a limit as $t \rightarrow \infty$. These facts can be used to show that solutions *stabilize*. Or in other words: as $t \rightarrow \infty$ every solution tends to some equilibrium u , in the sense that $\|w(.,t) - u\| \rightarrow 0$ as $t \rightarrow \infty$.

An equilibrium u is called *isolated* if some neighbourhood of u (in the sense of H^1) contains no other equilibria. The following theorems are easy consequences of the above.

THEOREM 7.2. *If u is stable and isolated, then u is asymptotically stable.*

PROOF. Take ϵ_0 so small that u is the only equilibrium in $\{\phi \mid \|u - \phi\| < \epsilon_0\}$. So, if ψ satisfies $\|\psi - u\| < \delta(\epsilon_0)$, we know that $\|w(.,t) - u\| < \epsilon_0$ and that $w(.,t)$ tends to an equilibrium as $t \rightarrow \infty$. Hence $w(.,t)$ tends to u . \square

THEOREM 7.3. *If u is isolated and $V(u)$ is not a minimum, then u is unstable.*

PROOF. As before, take ϵ_0 such that u is the only equilibrium in $\{\phi \mid \|u - \phi\| < \epsilon_0\}$. Suppose we can find a δ such that $\|w(.,t) - u\| < \epsilon_0$ for every ψ with $\|\psi - u\| < \delta$. Since V is not minimal at u we can find a function ψ with $\|\psi - u\| < \delta$ and $V(\psi) < V(u)$. Hence $V(w(.,t)) < V(u)$ for all $t \geq 0$. Thus, as $t \rightarrow \infty$, $w(.,t)$ tends to an equilibrium w different from u and yet satisfying $\|u - w\| < \epsilon_0$. This is clearly a contradiction. \square

8. NECESSARY AND SUFFICIENT CONDITIONS FOR A MINIMUM

The foregoing has made clear the special importance of critical points where V is minimal. In this section we derive criteria which are based on linearization at the equilibrium.

The functional V is twice Fréchet differentiable, so we can write out the first terms of a Taylor expansion:

$$(8.1) \quad V(u+\phi) = V(u) + L_u(\phi) + \frac{1}{2}Q_u(\phi) + R(u;\phi)$$

with

$$(8.2) \quad Q_u(\phi) = \int_{-1}^1 \{\phi_x^2 - \lambda g(x) f'(u) \phi^2\} dx$$

and

$$(8.3) \quad |R(u; \phi)| = o(\|\phi\|^2).$$

The quadratic functional $Q_u: H^1 \rightarrow \mathbb{R}$ is called the *second variation* of V . Note that the Euler equation for $Q_u(\phi)$ is the linearization of (5.3)

$$(8.4) \quad v_{xx} + \lambda g(x)F'(u)v = 0.$$

Now let u be a critical point of V (i.e., $L_u(\phi) = 0$ for all $\phi \in H^1$).

THEOREM 8.1. *If there exists $\tilde{\phi} \in H^1$ such that $Q_u(\tilde{\phi}) < 0$, then $V(u)$ is not a minimum.*

PROOF. For sufficiently small $\|\phi\|$, the sign of $V(u+\phi) - V(u)$ will be the same as the sign of $Q_u(\phi)$. Suppose there exists $\tilde{\phi} \in H^1$ such that $Q_u(\tilde{\phi}) < 0$. Since Q_u is a homogeneous quadratic functional, we have $Q_u(\eta\tilde{\phi}) < 0$ for every $\eta > 0$, and hence $V(u+\eta\tilde{\phi}) - V(u)$ is negative for small η . It follows that $V(u)$ cannot be a minimum. \square

COROLLARY 8.2 (a necessary condition). *If V is minimal at u , then $Q_u(\phi) \geq 0$ for all $\phi \in H^1$.*

THEOREM 8.3 (a sufficient condition). *If there exists an $a > 0$ such that $Q_u(\phi) \geq a\|\phi\|^2$ for all $\phi \in H^1$, then $V(u)$ is a minimum. Moreover, u is stable.*

PROOF. $V(u+\phi) - V(u) = \frac{1}{2}Q_u(\phi) + R(u; \phi)$, and for every $\epsilon > 0$ there exists $\delta(\epsilon) > 0$ such that $|R(u; \phi)| < \epsilon\|\phi\|^2$ for all ϕ with $\|\phi\| < \delta(\epsilon)$. Take $\epsilon = \frac{1}{4}a$; then

$$V(u+\phi) - V(u) \geq \frac{1}{2}Q_u(\phi) - |R(u; \phi)| \geq \frac{1}{2}a\|\phi\|^2 - \frac{1}{4}a\|\phi\|^2 = \frac{1}{4}a\|\phi\|^2.$$

Hence $V(u+\phi) - V(u) > 0$ for all ϕ with $0 < \|\phi\| < \delta(\frac{1}{4}a)$, and $V(u)$ is a minimum as asserted. The stability of u follows from Theorem 7.1 (take $h(s) = \frac{1}{4}as^2$). \square

It is a standard result in the calculus of variations that criteria for the positivity of Q_u can be formulated in terms of a solution of the linearized equation (8.4). Our presentation of the proofs is based on [15].

Let $v(x)$ be defined by (8.4) and

$$(8.5) \quad v(-1) = 1, \quad v_x(-1) = 0.$$

Since the equation is linear the choice $v(-1) = 1$ is just a matter of normalization. The following observation will be useful in the sequel: multiplication of (8.4) by v and integration by parts yields the identity

$$(8.6) \quad Q_u(v) = v(1)v_x(1).$$

THEOREM 8.4.

- (i) If $v > 0$ for $-1 \leq x \leq 1$ and $v_x(1) \geq 0$, then $Q_u(\phi) \geq 0$ for all $\phi \in H^1$.
(ii) If $Q_u(\phi) \geq 0$ for all $\phi \in H^1$, then $v > 0$ for $-1 \leq x < 1$, and if $v(1) > 0$, then $v_x(1) \geq 0$.

PROOF.

- (i) For arbitrary $y \in C^1$ the equality

$$\begin{aligned} Q_u(\phi) &= \int_{-1}^1 \{ \phi_x^2 - \lambda g(x) f'(u) \phi^2 \} dx \\ &= \int_{-1}^1 (\phi_x + y\phi)^2 dx + \int_{-1}^1 \{ y_x - y^2 - \lambda g(x) f'(u) \} \phi^2 dx - \phi^2 y \Big|_{-1}^1 \end{aligned}$$

holds. The idea of the proof is to take for y a solution of the differential equation

$$y_x - y^2 - \lambda g(x) f'(u) = 0.$$

This is a so-called Riccati equation, and the change of variables

$$(8.7) \quad y = -\frac{v_x}{v}$$

leads to (8.4). The hypothesis implies that (8.7) is well defined and that

$$Q_u(\phi) = \int_{-1}^1 \left(\phi_x - \frac{v_x}{v} \phi \right)^2 dx + \frac{v_x(1)}{v(1)} \phi^2(1) \geq 0.$$

- (ii) Denote, for the moment, the value of λ by $\bar{\lambda}$. The idea of the proof is to show that no zero of v can appear as we let λ vary from 0 to $\bar{\lambda}$. We embody the dependence on λ in the notation by writing Q_u^λ and $v(x, \lambda)$. As a preliminary step we note that if $\lambda < \bar{\lambda}$, then

$$Q_u^\lambda(\phi) = \frac{\lambda}{\bar{\lambda}} Q_u^{\bar{\lambda}}(\phi) + \left(1 - \frac{\lambda}{\bar{\lambda}}\right) \int_{-1}^1 \phi^2 dx$$

implies $Q_u^\lambda(\phi) > 0$ unless ϕ is constant almost everywhere.

Suppose $v(\bar{x}, \bar{\lambda}) = 0$ for some $\bar{x} \in (-1, 1)$. The fundamental theorems for solutions of the initial value problem for ordinary differential equations (see for instance [17, Chapter 1]) imply $v_x(\bar{x}, \bar{\lambda}) \neq 0$ (uniqueness) and $v(x, \lambda)$ is a continuously differentiable function of λ . According to the implicit function theorem the equation $v(x, \lambda) = 0$ defines a continuous curve of solutions $x = x(\lambda)$ in a neighbourhood of $(\bar{x}, \bar{\lambda})$. We show that no such curve $x(\lambda)$ can exist:

- A. $x(\lambda)$ cannot terminate inside the rectangle $-1 \leq x \leq 1$, $0 \leq \lambda \leq \bar{\lambda}$, since at the end point we would have $v = 0$ by continuity, and the above reasoning can be repeated.
- B. $x(\lambda)$ cannot intersect the segment $x = 1$, $0 \leq \lambda \leq \bar{\lambda}$, for then $Q_u^\lambda(v(\cdot, \lambda)) = v(1, \lambda)v_x(1, \lambda) = 0$, whereas $v \neq \text{constant}$.
- C. Since $v(x, 0) \equiv 1$, $x(\lambda)$ cannot intersect the segment $\lambda = 0$, $-1 \leq x \leq 1$.
- D. By definition, $v(-1, \lambda) = 1$ and therefore $x(\lambda)$ cannot intersect the segment $x = -1$, $0 \leq \lambda \leq \bar{\lambda}$.
- E. $x(\lambda)$ cannot intersect the segment $\lambda = \bar{\lambda}$, $-1 \leq x \leq 1$, for then for some $\tilde{\lambda}$ we would have $v_x(x(\tilde{\lambda}), \tilde{\lambda}) = 0$.

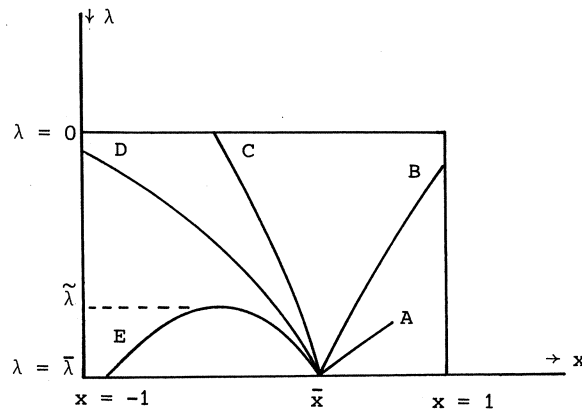

Figure 6

We have excluded every possibility, and thus it is shown that $v(x, \bar{\lambda}) > 0$ for $-1 \leq x < 1$. Furthermore, the identity $Q_u^{\bar{\lambda}}(v(\cdot, \bar{\lambda})) = v(1, \bar{\lambda})v_x(1, \bar{\lambda})$ implies that $v_x(1, \bar{\lambda}) \geq 0$ if $v(1, \bar{\lambda}) > 0$. \square

9. GATHERING TOGETHER THE PIECES

Let us apply the general criteria to the equilibria of (5.1).

THEOREM 9.1. *If either $\int_{-1}^1 g(x)f'(u)dx > 0$ or $\int_{-1}^1 g(x)f'(u)dx = 0$ and $g(x)f'(u)$ is not identically zero, then $v(u)$ is not a minimum, and if u is isolated, then u is unstable.*

PROOF. If $\int_{-1}^1 g(x)f'(u)dx > 0$, then $Q_u(c) < 0$ for all nonzero constants. If $\int_{-1}^1 g(x)f'(u)dx = 0$, then $Q_u(c) = 0$. Suppose $Q_u(\phi) \geq 0$ for all $\phi \in H^1$; then constants minimize Q_u . Since constants do not satisfy (8.4) this is impossible. So in all cases $Q_u(\tilde{\phi}) < 0$ for some $\tilde{\phi} \in H^1$, and the conclusion follows from Theorems 8.1 and 7.3. \square

In the special case $g(x)f'(u) \equiv 0$, linearization yields no information and one has to consider higher order derivatives. We eliminate this possibility for the trivial equilibria by a further assumption concerning the function f .

ASSUMPTION. $f'(0) > 0$, $f'(1) < 0$.

COROLLARY 9.2. *If $\int_{-1}^1 g(x)dx = 0$, then u^* is nontrivial for all λ .*

PROOF. We have to exclude the possibility that one of the trivial equilibria, though not a minimum, minimizes V on X . Since $Q_{u^i}(\pm|\phi|) = Q_{u^i}(\phi)$, $i = 0, 1$, we may suppose that $\tilde{\phi}$, from the proof of Theorem 9.1, satisfies $\tilde{\phi} \geq 0$ if $i = 0$ and $\tilde{\phi} \leq 0$ if $i = 1$, and thus neither u^0 nor u^1 minimize V on X . \square

The following lemma will be useful in discussing the case $\int_{-1}^1 g(x)f'(u)dx < 0$.

LEMMA 9.3. *Let $\int_{-1}^1 g(x)f'(u)dx < 0$; then there exist $\beta > 0$, $\gamma > 0$ such that*

$$\int_{-1}^1 \phi_x^2 dx \geq \beta \int_{-1}^1 \phi^2 dx \quad \text{on } \{ \phi \mid \int_{-1}^1 g(x)f'(u)\phi^2 dx > -\gamma \int_{-1}^1 \phi^2 dx \}.$$

PROOF. Choose $-2\gamma > \int_{-1}^1 g(x)f'(u)dx$. Suppose for each $\beta > 0$ once can find $\phi \in H^1$ such that

$$(9.1) \quad \int_{-1}^1 g(x)f'(u)\phi^2 dx > -\gamma \int_{-1}^1 \phi^2 dx$$

and

$$\int_{-1}^1 \phi_x^2 dx < \beta \int_{-1}^1 \phi^2 dx.$$

Since all expressions are quadratic we can normalize ϕ by $\int_{-1}^1 \phi^2 dx = 1$. Choose a sequence $\beta_n \downarrow 0$ and take a corresponding sequence $\phi^n \in H^1$. From the normalization and $\int_{-1}^1 (\phi_x^n)^2 dx \rightarrow 0$ it follows that $\{\phi^n\}$ is bounded in H^1 and therefore a subsequence converges weakly to an element of H^1 , say $\tilde{\phi}$. From $\int_{-1}^1 \tilde{\phi}_x^2 dx = 0$ and $\int_{-1}^1 \tilde{\phi}^2 dx = 1$ we deduce that $\tilde{\phi}^2 = \frac{1}{2}$ almost everywhere, and hence from

$$\int_{-1}^1 g(x)f'(u)\tilde{\phi}^2 dx \geq -\gamma \int_{-1}^1 \tilde{\phi}^2 dx$$

we obtain $\int_{-1}^1 g(x)f'(u)dx \geq -2\gamma$ which contradicts the chosen property of γ . \square

THEOREM 9.4. If $\int_{-1}^1 g(x)f'(u)dx < 0$ and $g(x)f'(u) \leq 0$ for $-1 \leq x \leq 1$, then u is stable.

PROOF. We show the existence of a number $a > 0$ such that $Q_u(\phi) \geq a\|\phi\|^2$ for all $\phi \in H^1$, and then the conclusion follows from Theorem 8.3. Let β, γ be as defined in Lemma 9.3. For arbitrary $\phi \in H^1$ we have either

$$\int_{-1}^1 g(x)f'(u)\phi^2 dx \leq -\gamma \int_{-1}^1 \phi^2 dx \text{ and then } Q_u(\phi) \geq \int_{-1}^1 \{\phi_x^2 + \lambda\gamma\phi^2\} dx,$$

or

$$\begin{aligned} \int_{-1}^1 g(x)f'(u)\phi^2 dx > -\gamma \int_{-1}^1 \phi^2 dx \text{ and then } Q_u(\phi) &\geq \int_{-1}^1 \phi_x^2 dx \\ &\geq \frac{1}{2} \int_{-1}^1 \{\phi_x^2 + \beta\phi^2\} dx. \end{aligned}$$

Take $a = \min(\lambda\gamma, \frac{1}{2}, \frac{1}{2}\beta)$. \square

In the beginning of Section 5 we assumed that g takes both positive and negative values on $[-1,1]$ and therefore Theorem 9.4 is not applicable to the trivial equilibria.

Suppose $g(x)f'(u)$ changes sign on $[-1,1]$; then the set

$$Y = \left\{ \phi \in H^1 \mid \int_{-1}^1 g(x)f'(u)\phi^2 dx > 0 \right\}$$

is not empty. Consider the so-called Rayleigh quotient

$$(9.2) \quad K(\phi) = \frac{\int_{-1}^1 \phi_x^2 dx}{\int_{-1}^1 g(x)f'(u)\phi^2 dx}.$$

K is bounded from below on Y and we define

$$(9.3) \quad \lambda_1(u) = \inf_{\phi \in Y} K(\phi).$$

THEOREM 9.5. *Suppose $\int_{-1}^1 g(x)f'(u)dx < 0$ and $g(x)f'(u)$ changes sign on $[-1,1]$. If it turns out that*

- (i) $\lambda_1(u) > \lambda$, then u is stable;
- (ii) $\lambda_1(u) = \lambda$, then $Q_u(\phi) \geq 0$ for all $\phi \in H^1$ and $v_x(1) = 0$;
- (iii) $\lambda_1(u) < \lambda$, then $v(u)$ is not a minimum and if u is isolated, then u is unstable.

PROOF.

- (i) Write $\lambda = (1-\delta)\lambda_1(u)$. Whenever $\int_{-1}^1 g(x)f'(u)\phi^2 dx > 0$ the definition of $\lambda_1(u)$ implies $\delta \int_{-1}^1 \phi_x^2 dx \leq Q_u(\phi)$. Since $\delta < 1$, this assertion remains true if $\int_{-1}^1 g(x)f'(u)\phi^2 dx \leq 0$. If

$$\int_{-1}^1 g(x)f'(u)\phi^2 dx > -\gamma \int_{-1}^1 \phi^2 dx, \text{ then } Q_u(\phi) \geq \frac{1}{2}\delta \int_{-1}^1 \{\phi_x^2 + \beta\phi^2\} dx$$

by Lemma 9.3, whereas in the opposite case $Q_u(\phi) \geq \int_{-1}^1 \{\phi_x^2 + \lambda\gamma\phi^2\} dx$. Let $a = \min(\lambda\gamma, \frac{1}{2}\delta, \frac{1}{2}\delta\beta)$ and apply Theorem 8.3.

- (ii) The first part follows from the definition of $\lambda_1(u)$. For the second part we can take a minimizing sequence in $Y \cap \{\phi \in H^1 \mid \int_{-1}^1 \phi^2 dx = 1\}$ and use the weak lower semi-continuity of Q_u (compare the proof of Theorem 6.2). We obtain a solution of equation (8.4) subject to homogeneous Neumann boundary conditions and, by the linearity of equation (8.4), this solution must be $c v$ for some constant $c \neq 0$.
- (iii) This follows from the definition of $\lambda_1(u)$ and the Theorems 8.1 and 7.3. \square

Theorem 9.5 tells us that the calculation of a number $\lambda_1(u)$, defined in

terms of the Rayleigh quotient (9.2), gives quite a lot of information concerning the stability of u . The relation with the linearized equation is even more explicit in the criteria of the following corollary.

COROLLARY 9.6. *Suppose $g(x)f'(u)$ is not identically zero.*

- (i) *A sufficient condition for stability of u is: $v > 0$ for $-1 \leq x \leq 1$ and $v_x(1) > 0$.*
- (ii) *If u is isolated, then the conditions $v > 0$ for $-1 \leq x \leq 1$ and $v_x(1) \geq 0$ if $v(1) > 0$ are necessary for stability.*

PROOF.

- (i) By Theorem 8.4(i), $Q_u(\phi) \geq 0$ for all $\phi \in H^1$. This excludes $\int_{-1}^1 g(x)f'(u)dx \geq 0$ and $\int_{-1}^1 g(x)f'(u)dx < 0$, $\lambda > \lambda_1(u)$, whereas $\lambda = \lambda_1(u)$ is excluded by $v_x(1) > 0$.
- (ii) By Theorems 9.4 and 9.5, $Q_u(\phi) \geq 0$ for all $\phi \in H^1$ and the conclusion follows from Theorem 8.4(ii). \square

In general, if we let λ vary, equilibria are functions of λ and consequently λ_1 is a function of λ . But in the special case of the trivial equilibria u^0 and u^1 , λ_1 is a number independent of λ .

THEOREM 9.7.

- (i) *Suppose $\int_{-1}^1 g(x)dx < 0$; then u^* is nontrivial for $\lambda > \lambda_1(u^0)$.*
- (ii) *Suppose $\int_{-1}^1 g(x)dx > 0$; then u^* is nontrivial for $\lambda > \lambda_1(u^1)$.*

PROOF.

- (i) Theorem 9.1 shows that u^1 does not minimize V on X , and Theorem 9.5 implies the same for u^0 .
- (ii) Exchange u^0 and u^1 in the above. \square

10. BIFURCATION OF EQUILIBRIA

In this section the dependence of equilibria on λ will be studied in some more detail. In particular, the bifurcation at $\lambda = \lambda_1$ of a nontrivial solution from the trivial one will be investigated. The ideas and methods of bifurcation theory are described in [18]. We mention the Lyapunov-Schmidt method, which is essentially a way of constructing a scalar equation for some parametrizing quantity. The following observation shows that, in this particular problem, a scalar equation can be found directly.

The theorems on the existence and uniqueness of solutions of the initial value problem for ordinary differential equations (see [17, Chapter 1]) show that the problem of finding equilibria is equivalent to the problem of finding those values of the real variable α for which $u(x, \alpha, \lambda)$ defined by

$$(10.1) \quad u_{xx} + \lambda g(x) f(u) = 0,$$

$$(10.2) \quad u(-1, \alpha, \lambda) = \alpha, \quad u_x(-1, \alpha, \lambda) = 0,$$

satisfies

$$(10.3) \quad u_x(1, \alpha, \lambda) = 0,$$

$$(10.4) \quad 0 \leq u \leq 1 \quad \text{for } x \in [-1, 1].$$

The scalar equation we have in mind is (10.3). But before we proceed, we state as another consequence a sufficient condition for isolated equilibria.

THEOREM 10.1. *Let f and g be (real) analytic functions. Then the number of equilibria is finite.*

PROOF. Since the result concerns a fixed value of λ , we suppress the dependence on λ in the notation. The assumption implies that $u_x(1, \alpha)$ is an analytic function of α . Suppose there are infinitely many $\alpha \in [0, 1]$ for which $u_x(1, \alpha) = 0$ and $0 \leq u \leq 1$ for $x \in [-1, 1]$. Then $u_x(1, \alpha) \equiv 0$. By continuity the set

$$I = \{\alpha \in [0, 1] \mid 0 \leq u(x, \alpha) \leq 1 \text{ for all } x \in [-1, 1]\}$$

consists of a number of closed intervals. Suppose $\gamma \neq 0, 1$ is an end point of such an interval. Then either $u(\bar{x}, \gamma) = 0$ or $u(\bar{x}, \gamma) = 1$ for some $\bar{x} \in (-1, 1]$. Since $u_x(1, \gamma) = 0$ the case $\bar{x} = 1$ is excluded by the uniqueness theorem. But $0 \leq u(x, \gamma) \leq 1$ implies $u_x(\bar{x}, \gamma) = 0$ if $\bar{x} \in (-1, 1)$ and therefore, invoking uniqueness again, no such \bar{x} can exist. Finally, if $I = [0, 1]$, then from

$$\frac{d}{d\alpha} V(u(\cdot, \alpha)) = \int_{-1}^1 \left\{ u_x \left(\frac{\partial u}{\partial \alpha} \right)_x - \lambda g(x) f(u) \frac{\partial u}{\partial \alpha} \right\} dx = 0$$

(the second equality follows from $\frac{\partial u}{\partial \alpha} \in H^1$ and the fact that u is a critical point of V), it follows that V is constant for all $\alpha \in I$. Thus the assump-

tion leads to $V(u^0) = V(u^1) = V(u^*)$, which cannot be true if $\lambda \neq 0$. \square

In the bifurcation analysis we confine ourselves to the representative case $\int_{-1}^1 g(x)dx < 0$. Then u^0 is stable for $\lambda < \lambda_1(u^0)$ and, if isolated, unstable for $\lambda > \lambda_1(u^0)$. We are looking for "small" solutions (i.e., small $|\alpha|$) of the equation

$$\Phi(\alpha, \lambda) = 0, \quad \text{where } \Phi(\alpha, \lambda) = u_x(1, \alpha, \lambda).$$

We note that $v(x, \alpha, \lambda) = \frac{\partial u}{\partial \alpha}(x, \alpha, \lambda)$ satisfies (8.4) and (8.5). Take $\alpha = 0$. As long as $\lambda < \lambda_1$ we know from Theorems 9.5 and 8.4 that $v(x, 0, \lambda) > 0$ for $-1 \leq x \leq 1$ and $v_x(1, 0, \lambda) > 0$ (recall that $Q_u(v) = v(1, \alpha, \lambda)v_x(1, \alpha, \lambda)$). Thus $\frac{\partial \Phi}{\partial \alpha}(0, \lambda) = v_x(1, 0, \lambda) \neq 0$, and the implicit function theorem implies uniqueness of the small solution of $\Phi(\alpha, \lambda)$, which solution is of course $\alpha \equiv 0$. Since $v_x(1, 0, \lambda_1) = 0$, at $\lambda = \lambda_1$ a bifurcation may occur. The uniqueness theorem implies $v(1, 0, \lambda_1) \neq 0$ and thus $v(x, 0, \lambda_1) > 0$ for $-1 \leq x \leq 1$. By continuity $v(x, \alpha, \lambda) > 0$ for $-1 \leq x \leq 1$ and λ, α in a neighbourhood of $\lambda_1, 0$. Invoking Theorems 9.5 and 8.4 again, we conclude that $v_x(1, 0, \lambda) < 0$ for $\lambda > \lambda_1$ and $\lambda - \lambda_1$ sufficiently small. So we know

$$(10.5) \quad \frac{\partial \Phi}{\partial \alpha}(0, \lambda) > 0 \quad \text{for } \lambda < \lambda_1, \quad \frac{\partial \Phi}{\partial \alpha}(0, \lambda) < 0 \quad \text{for } \lambda > \lambda_1 \quad \text{and } |\lambda - \lambda_1| \text{ small.}$$

The next goal is to calculate $\frac{\partial^2 \Phi}{\partial \alpha^2}(0, \lambda_1) = z_x(1, 0, \lambda_1)$, where $z(x, 0, \lambda) = \frac{\partial^2 u}{\partial \alpha^2}(x, 0, \lambda)$ satisfies

$$(10.6) \quad z_{xx} + \lambda g(x)\{f''(0)v^2(x, 0, \lambda) + f'(0)z\} = 0, \\ z(-1, 0, \lambda) = z_x(-1, 0, \lambda) = 0.$$

We multiply (10.6) by $v(x, 0, \lambda)$, integrate by parts twice, and use (8.4), to get for $\lambda = \lambda_1$

$$v(1, 0, \lambda_1)z_x(1, 0, \lambda_1) + \lambda_1 f''(0) \int_{-1}^1 g(x)v^3(x, 0, \lambda_1)dx = 0.$$

Multiplication of (8.4) by $v^2(x, 0, \lambda_1)$ followed by integration by parts yields

$$-2 \int_{-1}^1 v_x^2(x, 0, \lambda_1)v(x, 0, \lambda_1)dx + \lambda_1 f'(0) \int_{-1}^1 g(x)v^3(x, 0, \lambda_1)dx = 0,$$

and we obtain

$$\frac{\partial^2 \phi}{\partial \alpha^2}(0, \lambda_1) = - \frac{2f''(0)}{f'(0)v(1,0,\lambda_1)} \int_{-1}^1 v_x^2(x,0,\lambda_1)v(x,0,\lambda_1) dx.$$

Since $v(x,0,\lambda_1) > 0$ for $-1 \leq x \leq 1$ and $f'(0) > 0$ we conclude that

$$(10.7) \quad \text{sign } \frac{\partial^2 \phi}{\partial \alpha^2}(0, \lambda_1) = -\text{sign } f''(0).$$

In order to reduce the amount of calculation we assume that $f''(0) \neq 0$ (if $f''(0) = 0$ we have to consider higher order derivatives). From (10.5) and (10.7) we infer that $\phi(\alpha, \lambda) = 0$ has two roots, $\alpha = 0$ and $\alpha = \alpha(\lambda)$. The initial shape of the curve of bifurcating solutions and the stability character are shown in Figure 7.

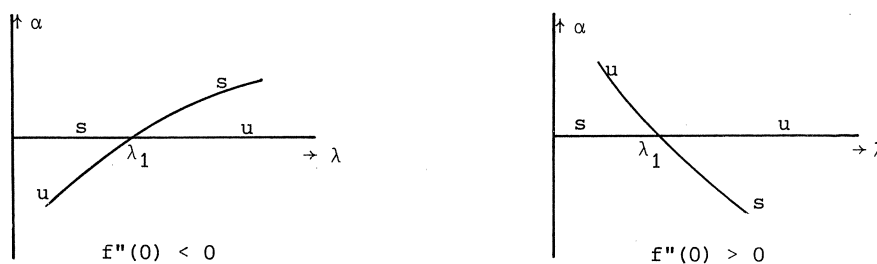

Figure 7

Taylor expansion yields

$$(10.8) \quad u(x, \alpha(\lambda), \lambda) = (\lambda - \lambda_1) \frac{\partial \alpha}{\partial \lambda}(\lambda_1) v(x, 0, \lambda_1) + o(|\lambda - \lambda_1|),$$

and hence $u(x, \alpha(\lambda), \lambda) \geq 0$ for $x \in [-1, 1]$ if $\alpha(\lambda) > 0$. So in the case $f''(0) < 0$ the bifurcating solution belongs to X for $\lambda > \lambda_1$ and is a candidate for being u^* , whereas if $f''(0) > 0$ the bifurcating solution belongs to X for $\lambda < \lambda_1$ and it cannot possibly be u^* . If $f''(0) > 0$ the situation might be as shown in Figure 8, but it might be much more complex as well.

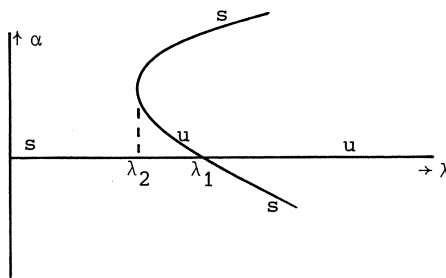

Figure 8

APPENDIX

In this appendix we show the one-to-one correspondence between the classical solutions of the boundary value problem (5.3), (5.4), solutions of the generalized problem (6.1), and the critical points of the functional V defined in (6.3).

The fact that critical points of V and solutions of (6.1) are the same follows from

$$\begin{aligned} \lim_{t \rightarrow 0} \frac{V(u+t\phi) - V(u)}{t} &= \\ &= \lim_{t \rightarrow 0} t^{-1} \left\{ \int_{-1}^1 (tu \phi_x + \frac{1}{2} t^2 \phi_x^2 - t\lambda g(x) f(u) \phi - t^2 \lambda g(x) f'(u) \phi^2 + \dots) dx \right\} \\ &= \int_{-1}^1 \{u \phi_x - \lambda g(x) f(u) \phi\} dx. \end{aligned}$$

Let u satisfy (5.3), (5.4), and let $\phi \in H^1$. Then multiplication of (5.3) by ϕ , followed by integration by parts, yields (6.1).

Suppose $u \in H^1$ is such that (6.1) holds. Let q be the solution of

$$q_{xx} = g(x)f(u), \quad q(-1) = q_x(-1) = 0.$$

For those $\phi \in C^2$ that satisfy $\phi_x(\pm 1) = 0$, $\phi(1) = 0$, partial integration yields

$$\int_{-1}^1 (u+\lambda q) \phi_{xx} dx = 0.$$

One of the basic lemmas of the calculus of variations ([15, p.10]) shows

$$u(x) + \lambda q(x) = c_0 + c_1 x.$$

Hence u is at least twice differentiable and u satisfies (5.3). Partial integration of (6.1) now yields

$$u_x(1)\phi(1) - u_x(-1)\phi(-1) = 0 \quad \text{for all } \phi \in H^1,$$

and thus u satisfies (5.4) too.

LITERATURE

- [1] COHEN, H., *Nonlinear diffusion problems*, in: A.H. Taub, ed., *Studies in Mathematics*, Vol. 7, Math. Assoc. of Amer. (1971) 27-64.
- [2] NAGUMO, J., ARIMOTO, S. & S. YOSHIZAWA, *An active pulse transmission line simulating nerve axon*, *Proc. Inst. Radio Eng.* 50 (1962) 2061-2070.
- [3] FITZHUGH, R., *Impulses and physiological states in theoretical models of nerve membrane*, *Biophysical J.* 1 (1961) 445-466.
- [4] HASTINGS, S.P., *Some mathematical problems from neurobiology*, *Amer. Math. Monthly* 82 (1975) 881-895.
- [5] TURING, A.M., *The chemical basis of morphogenesis*, *Philos. Trans. Roy. Soc. London Ser. B* 237 (1952) 37-72.
- [6] ROSEN, R., *Dynamical System Theory in Biology*, Vol. 1 (Wiley-Interscience, New York, 1970) Section 7.2.
- [7] COHEN, D.S., ed., *Mathematical Aspects of Chemical and Biochemical Problems and Quantum Chemistry*, SIAM-AMS Proceedings, Vol. VIII (AMS, Providence, R.I., 1974).
- [8] FISHER, R.A., *The advance of advantageous genes*, *Ann. Eugenics* 7 (1937) 355-369.

- [9] KOLMOGOROFF, A., PETROVSKY, I. & N. PISCOUNOFF, *Étude de l'équation de la diffusion avec croissance de la quantité de matière et son application à un problème biologique*, Bull. Univ. Moscou, Ser. Internat., Sec. A, 1 (1937), #6, 1-25.
- [10] ARONSON, D.G. & H.F. WEINBERGER, *Nonlinear diffusion in population genetics, combustion, and nerve pulse propagation*, in: J.A. Goldstein, ed., *Partial Differential Equations and Related Topics*, Lecture Notes in Math. 446 (Springer-Verlag, Berlin, 1975) 5-49.
- [11] WILLEMS, G.M. & H.C. HEMKER, *The necessary and sufficient requirements for the existence of dissipative structures in (bio)chemical systems*, Report TN 77/73, Mathematisch Centrum, Amsterdam, 1973.
- [12] CHAFEE, N., *Asymptotic behavior for solutions of a one-dimensional parabolic equation with homogeneous Neumann boundary conditions*, J. Diff. Equ. 18 (1975) 111-134.
- [13] FLEMING, W.H., *A selection-migration model in population genetics*, J. Math. Biol. 2 (1975) 219-233.
- [14] GROESEN, E.W.C. van, *Variational methods for nonlinear operator equations*, in: N.M. Temme, ed., *Nonlinear Analysis Vol. II*, MC Syllabus 26.2 (Mathematisch Centrum, Amsterdam, 1976) Chapter X.
- [15] GELFAND, I.M. & S.V. FOMIN, *Calculus of Variations* (Prentice-Hall, Englewood Cliffs, N.J., 1963).
- [16] LA SALLE, J.P. & S. LEFSCHETZ, *Stability by Lyapunov's direct method with applications* (Academic Press, New York, 1961).
- [17] CODDINGTON, E.A. & N. LEVINSON, *Theory of Ordinary Differential Equations* (McGraw-Hill, New York, 1955).
- [18] TEMME, N.M., ed., *Nonlinear Analysis, Vols I and II*, MC Syllabi 26.1 and 26.2 (Mathematisch Centrum, Amsterdam, 1976).

II. EXISTENCE AND UNIQUENESS OF ONE-DIMENSIONAL NONLINEAR PARABOLIC EQUATIONS

In this chapter we introduce some topics that will be needed in the following chapters. Section 1 gives results based on the maximum principle. Many problems on the existence and uniqueness of solutions of differential equations can be solved using these methods. In Section 2 function classes are discussed. In the previous chapter something was said about the Sobolev space H^1 . Here, we give more information about Sobolev function classes, together with Hölder classes. In the last section results from the theory of nonlinear parabolic differential equations are given. We give theorems on the existence and regularity of equations of this kind.

The topics in this chapter are not treated to their full extent. We have tried to give those results that will be needed for specific problems in later chapters, and the results are therefore not formulated in the most general form.

1. MAXIMUM PRINCIPLES

In this section we consider an important and powerful tool in the study of second order partial differential equations: the maximum principle. This principle is a generalization of the elementary fact of calculus that any twice continuously differentiable function f which satisfies $f'' > 0$ on an interval $[a,b]$ achieves its maximum value at one of the end points of the interval.

The maximum principle serves as a fundamental basis for the proofs of uniqueness of various boundary value problems. Moreover, estimates for the solutions of partial differential equations can be made using the maximum principle.

Although the proofs required to establish the maximum principle are rather elementary, not all of them are given in this section. Also, only a few facts about the maximum principles are given, which are basic for the following chapters. For more details the reader is referred to the general reference for this section, the book of PROTTER & WEINBERGER [6].

1.1. The one-dimensional maximum principle

If a twice continuously differentiable function u in an open interval (a,b) has a relative maximum at some point $x \in (a,b)$, then

$$u'(x) = 0 \quad \text{and} \quad u''(x) \leq 0.$$

Suppose that u is known to satisfy a differential inequality of the form

$$(1.1) \quad u''(x) + g(x)u'(x) > 0, \quad x \in (a,b),$$

where g is a bounded function on (a,b) . Then such a u cannot have a relative maximum in (a,b) and if, moreover, u is continuous on the closed interval $[a,b]$, then

$$(1.2) \quad u(x) \leq M = \max\{u(a), u(b)\}, \quad x \in (a,b).$$

However, in applications where differential equations are studied, u satisfies

$$(1.3) \quad u''(x) + g(x)u'(x) \geq 0, \quad x \in (a,b).$$

Then, too, (1.2) holds and, moreover, if $u(x) = M$ for some $x \in (a,b)$, then $u(x) \equiv M$. In proving this one uses an auxiliary function v in order to reduce this case to one where the strict inequality (1.1) holds: assume that there are $a < c < d < b$ such that $u(c) = M' \neq u(d)$, where $M' \geq M = \max\{u(a), u(b)\}$. Let

$$v(x) = e^{\alpha(x-c)} - 1;$$

then

$$v''(x) + g(x)v'(x) = \alpha\{\alpha + g(x)\}e^{\alpha(x-c)} > 0$$

if α is sufficiently large. For positive $\epsilon < |M' - u(d)|/v(b)$ let

$$w(x) = u(x) + \epsilon v(x).$$

Then

$$w'' + gw' > 0,$$

$$w(a) < M',$$

$$w(c) = M'$$

and

$$w(d) < M', \quad \text{or} \quad \begin{cases} M' < w(d), \\ w(b) < w(d), \end{cases}$$

depending on whether $M' > u(d)$ or $M' < u(d)$, respectively. This can never

happen, since w cannot have a maximum at an interior point of (a,d) or (a,b) . If we had assumed $d < c$, we should have taken

$$v(x) = e^{-\alpha(x-c)} - 1.$$

It is easy to see that a function u satisfying

$$(1.4) \quad u''(x) + g(x)u'(x) + h(x)u(x) > 0, \quad x \in (a,b)$$

cannot have a nonnegative maximum in the interior of (a,b) when $h \leq 0$ on (a,b) . If u only satisfies (1.4) with the \geq sign, we proceed as before, choosing α so large that

$$\alpha^2 \pm \alpha g(x) + h(x)\{1 - e^{-\alpha(x-c)}\} \geq \alpha^2 - \alpha|g(x)| + h(x) > 0$$

on (a,b) . This is always possible if g and h are bounded on (a,b) . We can apply the same argument to any subinterval of (a,b) , so that it is sufficient for g and h to be bounded on any closed subinterval of (a,b) . Thus we have obtained the following theorem.

THEOREM 1.1. *If a twice continuously differentiable function u on an open interval (a,b) satisfies the differential inequality*

$$(1.5) \quad u''(x) + g(x)u'(x) + h(x)u(x) \geq 0, \quad x \in (a,b),$$

with $h(x) \leq 0$, if g and h are bounded on any closed subinterval, and if u attains a maximum M , which is nonnegative if $h \not\equiv 0$, at an interior point of (a,b) , then $u(x) \equiv M$.

The condition that g and h are bounded cannot be omitted without further restrictions. The equation

$$u''(x) - \frac{3}{x}u'(x) = 0$$

has the solution $u(x) = 1 - x^4$ in the interval $(-1,1)$, which attains a maximum at $x = 0$. However, from Theorem 1.2 it will follow that the conclusion of Theorem 1.1 holds for a continuously differentiable function u on (a,b) , with $a < 0 < b$, satisfying

$$u''(x) + \frac{1}{x}u'(x) \geq 0$$

for all $x \in (a,b)$, with the exception of $x = 0$ if u is not twice continuously differentiable there (for example $u(x) = x\sqrt{x}$ for $x \geq 0$ and $u(x) = 0$ for $x < 0$).

The functions u of Theorem 1.1 that are continuous on $[a,b]$ attain their maximum at the boundary of (a,b) , but at the point c where the maximum is attained we do not have that $u'(c) = 0$ unless u is constant. For, let u satisfy (1.5), let $u(a) = M$ and let $u(d) < M$ for some $d \in (a,b)$, and let $M \geq 0$ if $h \neq 0$. Choose α so large that the function

$$v(x) = e^{\alpha(x-a)} - 1$$

satisfies the strict inequality (1.4). This is possible if $g(x) + (x-a)h(x)$ is bounded from below. With $0 < \epsilon < (M-u(d))/v(d)$ we define the function

$$w(x) = u(x) + \epsilon v(x).$$

Since w satisfies (1.4) in (a,d) , the maximum of w must occur at one of the end points. We have $w(a) = M > w(d)$, so that the maximum occurs at a . Hence

$$w'(a) = u'(a) + \epsilon v'(a) \leq 0,$$

and since $v'(a) = \alpha > 0$ we finally get

$$u'(a) < 0.$$

THEOREM 1.2. *Suppose that u is a nonconstant solution of the differential inequality (1.5) having one-sided derivatives at a and b , that $h(x) \leq 0$, and that g and h are bounded on every closed subinterval of (a,b) . If u has a relative maximum at a which is nonnegative if $h \neq 0$, and if the function $g(x) + (x-a)h(x)$ is bounded from below at $x = a$, then $u'(a) < 0$. If u has a relative maximum at b which is nonnegative if $h \neq 0$, and if $g(x) - (b-x)h(x)$ is bounded from above at $x = b$, then $u'(b) > 0$.*

1.2. The maximum principle for the Laplace equation

As our main interest is in parabolic equations, in this section we only give results for the Laplace operator Δ in a domain $D \subset \mathbb{R}^n$, similarly to Theorems 1.1 and 1.2. We assume that u is a twice continuously differentiable function in D .

THEOREM 1.3. *Let u satisfy the differential inequality*

$$(1.6) \quad \Delta u(x) + h(x)u(x) \geq 0$$

in a domain $D \subset \mathbb{R}^n$, where h is a nonpositive function which is bounded on any compact subset of D . If u attains a maximum M , which is nonnegative if $h \not\equiv 0$, at an interior point of D , then $u(x) \equiv M$.

THEOREM 1.4. *Let u satisfy the differential inequality (1.6), where now h is nonpositive and bounded in D . Suppose that $u \leq M$ in D , $u \not\equiv M$, that $u = M$ at a boundary point P of D , and that $M \geq 0$ if $h \not\equiv 0$. Assume furthermore that P also lies on the boundary of an open ball in D . If u is continuous in $D \cup P$ and if an inward directional derivative $\partial u / \partial \nu$ exists at P , then*

$$\frac{\partial u}{\partial \nu} < 0 \quad \text{at } P.$$

The proofs of these theorems can be found in [6, Chapter II, Th. 2, 6 and 7]. The same argument as in Section 1.1 is used, here with the function v something like $\exp(-\alpha \sum_{i=1}^n x_i^2)$.

If u is continuous on \bar{D} and if D is bounded, then the functions u of Theorem 1.3 satisfy

$$(1.7) \quad u(x) \leq M = \max_{y \in \partial D} u(y), \quad x \in D,$$

where M must be nonnegative if $h \not\equiv 0$. If $u \not\equiv M$, then the strict inequality holds (cf. (1.2)). In the unbounded domain $D = \{(x, y) \mid 0 < y < \pi\} \subset \mathbb{R}^2$ the function $e^x \sin y$ is harmonic, vanishes on the boundary ∂D of D , but is positive everywhere in D . However, if we moreover require that u is bounded on \bar{D} , then (1.7) holds for unbounded domains too [6, Chapter II, Section 9].

A minimum principle arises if we change the sign \geq into \leq in (1.6) and \leq into \geq in (1.7), provided that $M \leq 0$ if the nonpositive function h does not vanish identically.

The maximum principle can be applied to prove the uniqueness of a bounded harmonic function in a domain D which tends to prescribed values at the boundary of D . Since the difference of two such functions is harmonic in D and vanishes on ∂D , it is nonpositive in all of D . For the same reason it is nonnegative in all of D , and hence it is identically zero.

Another application of the maximum principle (and the minimum principle) yields estimates for the solution of a boundary value problem where this so-

lution is not known exactly: Let an elastic membrane be braced between the points of the set

$$\{(x,y,z) \mid x=0, 0 \leq y \leq \pi, z=f(y)\} \cup \{(x,y,z) \mid z=0, y=0 \text{ or } y=\pi, 0 \leq x \leq a\},$$

where f is a continuous function on $[0,\pi]$ vanishing at 0 and π .

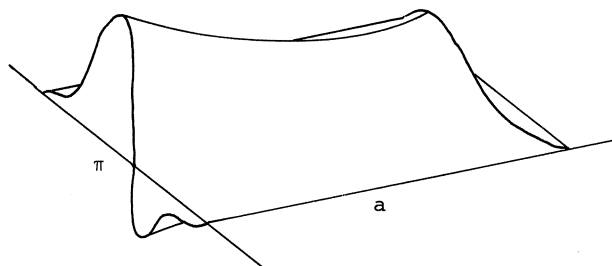

Figure 1

We want to have an estimate of the height z of the membrane on $\{(x,y) \mid x = a, 0 \leq y \leq \pi\}$. In this set, which is a free boundary for the membrane, we have $\partial z / \partial x = 0$. Assume that $\alpha \geq 0$ and $\beta \geq 0$ such that

$$\alpha + \beta \sin y \geq f(y), \quad y \in [0,\pi].$$

Let u be the function

$$u(x,y) = (\alpha + \beta \sin y) \frac{\cosh(x-a)}{\cosh a}, \quad (x,y) \in [0,a] \times [0,\pi].$$

We extend the domain of definition of the functions z and u to the set $D = [0,2a] \times [0,\pi]$ by reflecting z and u with respect to $x = a$. Then

$$\frac{\partial u}{\partial x}(a,y) = \frac{\partial z}{\partial x}(a,y) = 0 \quad \text{for } y \in [0,\pi]$$

and u satisfies

$$\begin{aligned} \Delta u &\geq 0 && \text{in } D, \\ u(x,0) &= u(x,\pi) = \alpha \cosh(x-a)/\cosh a \geq 0, \\ u(0,y) &\geq z(0,y), && y \in [0,\pi], \\ u(2a,y) &\geq z(2a,y), && y \in [0,\pi]. \end{aligned}$$

Hence

$$z(a,y) \leq \frac{\alpha + \beta \sin y}{\cosh a}, \quad y \in [0,\pi].$$

In the same way, if $\gamma \geq 0$ and $\delta \geq 0$ are such that

$$-\gamma - \delta \sin y \leq f(y), \quad y \in [0,\pi],$$

we get

$$z(a,y) \geq \frac{-\gamma - \delta \sin y}{\cosh a}, \quad y \in [0,\pi].$$

Similarly, if $a = \infty$ and z is bounded, we take

$$u(x,y) = (\alpha + \beta \sin y) e^{-x}$$

and find

$$(-\gamma - \delta \sin y) e^{-x} \leq z(x,y) \leq (\alpha + \beta \sin y) e^{-x}, \quad x \geq 0, \quad y \in [0,\pi].$$

1.3. The maximum principle for one-dimensional parabolic equations

The differential operator

$$(1.8) \quad L = f \frac{\partial^2}{\partial x^2} + g \frac{\partial}{\partial x} - \frac{\partial}{\partial t},$$

with f and g functions in a domain D in the (x,t) -plane, is said to be uniformly parabolic in D if there is a positive constant μ such that

$$f(x,t) \geq \mu, \quad (x,t) \in D.$$

Throughout this section we assume that u , u_x , u_{xx} and u_t are continuous functions in D .

First we will prove a maximum principle, similar to (1.2), when D is rectangular,

$$D = \{(x,t) \mid a < x < b, \ 0 < t < T\}.$$

However, unlike (1.7), we do not need all of the boundary: on the part $t = T$, $a < x < b$ of the boundary of D u cannot be larger than on the rest of the boundary.

Let f and g be bounded functions on \bar{D} , let u_x , u_{xx} and u_t be continuous on $(a,b) \times (0,T]$, and let u be continuous on \bar{D} . Then for $x_0 \in (a,b)$ and $t_0 \in (0,T]$

$$(1.9) \quad u(x_0, t_0) \leq M = \sup\{u(x,t) \mid (x,t) \in \partial D \text{ and } t < t_0\}.$$

provided that u satisfies

$$Lu \geq 0 \quad \text{in } D$$

or

$$(L+h)u \geq 0 \quad \text{in } D$$

if h is bounded on \bar{D} , $h \leq 0$ and $M \geq 0$. The proof uses a similar argument to that in Section 1.1. Let

$$v(x,t) = \exp(-\alpha(x-x_0)^2) - 1$$

with α so large that $(L+h)v > 0$ in D , i.e., with α so large that

$$4\alpha^2 f(x,t)(x-x_0)^2 - 2\alpha\{f(x,t) + g(x,t)(x-x_0)\} + h(x,t) > 0.$$

The function $w = u + v$ satisfies

$$(L+h)w > 0,$$

and if $u(x_0, t_0) > M$, then for $t \leq t_0$ and $(x,t) \in \partial D$ (but if $t_0 = T$ and $t = t_0$, only for $x = a$ or b)

$$w(x,t) < w(x_0, t_0).$$

This cannot be true, since if it were there would be $x_1 \in (a,b)$ and $t_1 \in (0,T]$ such that

$$\frac{\partial^2 w}{\partial x^2}(x_1, t_1) \leq 0, \quad \frac{\partial w}{\partial x}(x_1, t_1) = 0, \quad \frac{\partial w}{\partial t}(x_1, t_1) \geq 0,$$

and if $h \neq 0$, then also $w(x_1, t_1) \geq 0$, which contradicts $(L+h)w > 0$.

In fact a stronger result holds: if the maximum occurs in $(a,b) \times (0,T]$, then u must be constant in a certain region. We will formulate this result [6, Chapter 3, Th. 2 and 4] and a result similar to Theorems 1.2 and 1.4 [6, Chapter 3, Th. 3 and 4] for general domains D in the (x,t) -plane.

THEOREM 1.5. *Let D be a domain in the (x,t) -plane. Let the functions f , g and h be bounded on any compact subset of D , let $h \leq 0$ and let the differential operator (1.8) be uniformly parabolic in any compact subset of D . If*

$$(L+h)u \geq 0 \quad \text{in } D,$$

if $(x_0, t_0) \in D$ is such that $u(x_0, t_0) = M$, while $u(x,t) \leq M$ for $(x,t) \in D$, $t \leq t_0$, and if $M \geq 0$ when $h \neq 0$, then $u(x,t) = M$ on $\{(x,t) \mid t = t_0, x \in [x_1, x_2]\} \subset D$ with $x_1 \leq x_0 \leq x_2$ and on $\{(x,t) \mid x = x_0, t \in [t_1, t_0]\} \subset D$ with $t_1 < t_0$.

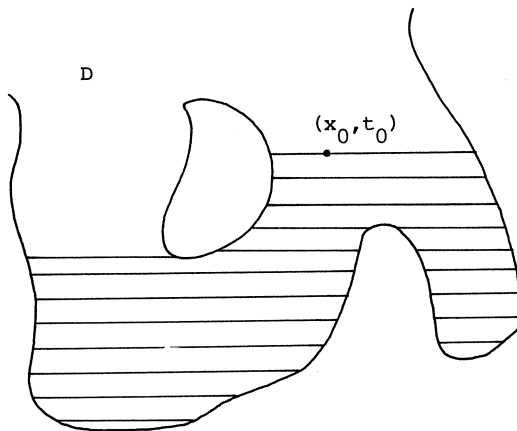

Figure 2

THEOREM 1.6. *Let D be a domain in the (x,t) -plane, let the functions f , g and h be bounded on $D_1 = D \cap \{(x,t) \mid t < T_1\}$ for any T_1 , let $h \leq 0$ in D , and let L , given by (1.8), be uniformly parabolic in any D_1 . Let $(L+h)u \geq 0$ in D . Suppose that P is a point on the boundary of D where the maximum M occurs, and that the normal to ∂D at P is not parallel to the t -axis. Furthermore, suppose that at P a circle tangent to ∂D can be constructed whose interior lies entirely in D and such that $u < M$ in this interior and that*

$M \geq 0$ if $h \neq 0$. If u is continuous in $D \cup P$ and if an inward directional derivative $\partial u / \partial v$ exists at P , then

$$\frac{\partial u}{\partial v} < 0 \quad \text{at } P.$$

Whether D is bounded or not, bounded solutions u of $(L+h)u \geq 0$ in D are maximal on that part of ∂D which is not a horizontal upper boundary (we choose the x -axis horizontal and the t -axis vertical), provided that this maximum is nonnegative if $h \neq 0$. From this property one can derive the uniqueness of solutions of parabolic differential equations.

COROLLARY 1.7. Let $D = (a,b) \times (0,T)$ with $0 < T \leq \infty$ and let $D_1 = D \cap \{(x,t) \mid t < T_1\}$. Let h be a function in D which is bounded from below on any compact subset of D and bounded from above on D_1 for any $T_1 < T$, and let L be as in Theorem 1.5. Let ψ be a bounded piecewise continuous function in (a,b) . Then there is at most one function u , bounded and continuous on

$$\{[a,b] \times (0,T_1]\} \cup \{(x,0) \mid \psi(x) \text{ is continuous}\}$$

for any $0 < T_1 < T$, with

$$\begin{aligned} (L+h)u &= 0 && \text{in } D, \\ u(x,0) &= \psi(x), && a < x < b, \quad \psi(x) \text{ is continuous,} \\ u(a,t) &= u(b,t) = 0, && 0 < t < T. \end{aligned}$$

PROOF. Let u_1 and u_2 both be solutions, and let $v(x,t) = e^{-\lambda t} \{u_1(x,t) - u_2(x,t)\}$ with λ so large that $h - \lambda \leq 0$ in D_1 . Then v satisfies

$$\begin{aligned} (L+h-\lambda)v &= 0, \\ v(x,0) &= 0, \quad v(a,t) = v(b,t) = 0. \end{aligned}$$

Therefore $v \leq 0$ everywhere in D_1 , and similarly $-v \leq 0$, so that $v \equiv 0$; hence $u_1 \equiv u_2$ in every D_1 , and thus in D . \square

COROLLARY 1.8. Let D , ψ and h be as in Corollary 1.7 and L as in Theorem 1.6. Then there is at most one solution u , bounded and continuous on $D_1 \cup \{(x,0) \mid \psi(x) \text{ is continuous}\}$ with u_x continuous on $[a,b] \times (0,T)$, of

$$\begin{aligned} (L+h)u &= 0 && \text{in } D, \\ u(x,0) &= \psi(x), && a < x < b, \quad \psi(x) \text{ is continuous,} \\ u_x(a,t) &= u_x(b,t) = 0, && 0 < t < T. \end{aligned}$$

PROOF. Let u_1 and u_2 both be solutions and let

$$v(x,t) = \{u_1(x,t) - u_2(x,t)\} \exp[-(x-c)^2 - \lambda t],$$

where $c \in (a,b)$ and λ so large that

$$\lambda \geq 4f(x,t)(x-c)^2 + 2g(x,t)(x-c) + 2f(x,t) + h(x,t), \quad (x,t) \in D_1.$$

Then v satisfies

$$\begin{aligned} f v_{xx} + [g + 4(x-c)f] v_x - v_t + [4(x-c)^2 f + 2(x-c)g + 2f + h - \lambda] v &= 0 \quad \text{in } D, \\ v(x,0) = 0, \quad v(a,t) &= \frac{1}{2(c-a)} v_x(a,t), \quad v(b,t) = \frac{-1}{2(b-c)} v_x(b,t). \end{aligned}$$

If the maximum M of v on \bar{D}_1 occurs on $\{(a,t) \mid 0 < t \leq T_1\} \cup \{(b,t) \mid 0 < t \leq T_1\}$, it must be nonnegative and for some $t_0 \in (0, T_1]$

$$M = v(a, t_0) = \frac{1}{2(c-a)} v_x(a, t_0) \leq 0,$$

or

$$-M = -v(b, t_0) = \frac{1}{2(b-c)} v_x(b, t_0) \geq 0.$$

Therefore $M = 0$ and similarly, applying the argument to $-v$, we find that v is nonnegative. Thus $v \equiv 0$ in D_1 for any $T_1 < T$, and hence $u_1 \equiv u_2$ in D . \square

We can compare two solutions of nonlinear parabolic equations by means of the maximum principle and the mean value theorem. Let $F(x,t,u,p)$ be a function on $(a,b) \times (0,T) \times \mathbb{R} \times \mathbb{R}$ which is continuously differentiable with respect to u and p , such that F_u is bounded from above on $(a,b) \times (0,T_1) \times \mathbb{R} \times \mathbb{R}$ for any $T_1 < T$. We consider the differential inequality

$$\begin{aligned} u_{xx}(x,t) + F(x,t,u(x,t),u_x(x,t)) - u_t(x,t) &\geq 0, \\ (x,t) &\in (a,b) \times (0,T) = D. \end{aligned}$$

Let w be a solution of

$$w_{xx}(x,t) + F(x,t,w(x,t),w_x(x,t)) - w_t(x,t) \leq 0, \quad (x,t) \in D.$$

Define a function g in D by

$$g(x,t) = \begin{cases} \frac{F(x,t,u(x,t),u_x(x,t)) - F(x,t,u(x,t),w_x(x,t))}{u_x(x,t) - w_x(x,t)}, & \text{if } u_x(x,t) \neq w_x(x,t), \\ \frac{\partial F}{\partial p}(x,t,u(x,t),u_x(x,t)), & \text{if } u_x(x,t) = w_x(x,t), \end{cases}$$

and a function h by

$$h(x,t) = \begin{cases} \frac{F(x,t,u(x,t),w_x(x,t)) - F(x,t,w(x,t),w_x(x,t))}{u(x,t) - w(x,t)}, & \text{if } u(x,t) \neq w(x,t), \\ \frac{\partial F}{\partial u}(x,t,u(x,t),w_x(x,t)), & \text{if } u(x,t) = w(x,t). \end{cases}$$

Then by the mean value theorem $g(x,t)$ equals

$$F_p(x,t,u(x,t),\theta(x,t)u_x(x,t) + [1-\theta(x,t)]w_x(x,t))$$

for some function θ between zero and one, and g is bounded on any compact subset of D . Similarly, $h(x,t)$ equals

$$F_u(x,t,\theta'(x,t)u(x,t) + [1-\theta'(x,t)]w(x,t),w_x(x,t))$$

and h is bounded from above on $D_1 = (a,b) \times (0,T_1)$ for any $T_1 < T$. Now the function $v = u - w$ satisfies $v_{xx} + gv_x - v_t + hv \geq 0$ in D . Similarly to Corollary 1.7, the following theorem holds.

THEOREM 1.9. *Let $D = (a,b) \times (0,T)$, where $a \geq -\infty$, $b \leq \infty$, $0 < T \leq \infty$. Let $F(x,t,u,p)$ be a function on $D \times \mathbb{R}^2$ such that F_u and F_p are continuous and that F_u is bounded from above on $D_1 \times \mathbb{R}^2$, where $D_1 = (a,b) \times (0,T_1)$, for any $0 < T_1 < T$. Let u and w be two bounded functions in D , which converge to piecewise continuous functions on $(a,b) \times \{0\}$, and if $a > -\infty$ also on $\{a\} \times (0,T)$, and if $b < \infty$ also on $\{b\} \times (0,T)$, satisfying*

$$w_{xx} + F(x,t,w,w_x) - w_t \leq u_{xx} + F(x,t,u,u_x) - u_t \quad \text{in } D$$

and

$$w(x,0) \geq u(x,0), \quad x \in (a,b).$$

Moreover, if $a > -\infty$ assume that

$$w(a,t) \geq u(a,t), \quad t \in [0,T)$$

and if $b < \infty$, assume that

$$w(b,t) \geq u(b,t), \quad t \in [0,T].$$

Then $w \geq u$ in D and if $w(x,0) > u(x,0)$ in an open interval of (a,b) , then $w > u$ in D .

The last inequality follows from the fact that the function $u - w$ cannot attain its nonpositive maximum at a point of D without being constant.

COROLLARY 1.10. *Let D and F be as in Theorem 1.9 and let ψ be as in Corollary 1.7. Then there is at most one bounded function u , continuous on*

$$D \cup \{(x,0) \mid \psi(x) \text{ is continuous}\} \cup \{(a,t) \mid 0 < t < T, \text{ if } a > -\infty\} \\ \cup \{(b,t) \mid 0 < t < T, \text{ if } b < \infty\},$$

with

$$(1.10) \quad \begin{aligned} u_{xx} + F(x,t,u,u_x) - u_t &= 0 && \text{in } D \\ u(x,0) &= \psi(x), && x \in (a,b), \quad \psi(x) \text{ is continuous} \\ u(a,t) &= 0, && t \in (0,T) \quad \text{if } a > -\infty \\ u(b,t) &= 0, && t \in (0,T) \quad \text{if } b < \infty. \end{aligned}$$

Just as Theorem 1.9 can be derived with the aid of Corollary 1.7, so the following corollary follows from Corollary 1.8.

COROLLARY 1.11. *Let D and F be as in Theorem 1.9 and moreover let F_p be bounded on $D_1 \times \mathbb{R}^2$ for any $0 < T_1 < T$. Let $a > -\infty$ and $b < \infty$ and let ψ be as in Corollary 1.7. Then there is at most one function u , continuous on $D \cup \{(x,0) \mid \psi(x) \text{ is continuous}\}$ with u_x continuous on $[a,b] \times (0,T)$ satisfying (1.10) in D and*

$$\begin{aligned} u(x,0) &= \psi(x), && a < x < b, \quad \psi(x) \text{ is continuous,} \\ u_x(a,t) &= u_x(b,t) = 0, && 0 < t < T. \end{aligned}$$

REMARK 1.12. In Theorem 1.9 and Corollaries 1.10 and 1.11 it would actually be sufficient if instead of F_u and F_p being continuous, F were only Lipschitz continuous with respect to u and p , uniformly in any $D_1 \times \mathbb{R}^2$.

2. FUNCTION SPACES

In this section we will treat two classes of function spaces, namely Hölder spaces and Sobolev spaces. The first one consists of continuously differentiable functions. Functions of the second class only have weak derivatives, i.e., derivatives in a distributional sense: let f be a locally integrable function in an open set $D \subset \mathbb{R}^n$; then the function g is called the *weak derivative* of f with respect to x_i (g is also denoted by $\partial f / \partial x_i$) if

$$\int_D g(x) \phi(x) dx = - \int_D f(x) \frac{\partial \phi}{\partial x_i}(x) dx$$

for all C^∞ -functions ϕ with support in D . Note that not all locally integrable functions in Ω have distributional derivatives which are functions as above, but in general they are distributions (see [7]). If a function is differentiable, weak derivatives equal ordinary derivatives. In this section we always assume that D is a domain in \mathbb{R}^n such that the boundary of its interior is the same as the boundary of its closure.

2.1. Hölder spaces

A function f in a domain D is called *uniformly Hölder continuous in D with exponent α* , $0 < \alpha \leq 1$, if for all $x, y \in D$

$$|f(x) - f(y)| \leq K|x - y|^\alpha$$

for some $K > 0$. If $\alpha = 1$ we also say that f is *Lipschitz continuous*. Let $0 < \alpha \leq 1$ and let ℓ be some nonnegative integer. Then $C^{\ell+\alpha}(D)$ is the space of all continuously differentiable functions f in D up to order ℓ , such that the derivatives of order ℓ are Hölder continuous in D with exponent α and such that the following norm is finite:

$$(2.1) \quad |f|_{\ell+\alpha} \stackrel{\text{def}}{=} \sup_{\substack{x \in D \\ |k| \leq \ell}} |D^k f(x)| + \sup_{\substack{x, y \in D \\ |k| = \ell}} \frac{|D^k f(x) - D^k f(y)|}{|x - y|^\alpha} .$$

If D is not open, it is required that the derivatives of order $\leq \ell$ can be continuously continued from the interior of D to all of D . $C^{\ell+\alpha}(D)$ is a Banach space (see [10, Section 7]). If $\ell = 0$, we sometimes denote the last term of (2.1) by $|f|_\alpha$ and then we have actually $|f|_{0+\alpha} = \|f\|_\infty + |f|_\alpha$.

THEOREM 2.1. *Let $0 < \alpha \leq 1$ and $0 < \beta \leq 1$, and let k and l be two nonnegative integers such that $k + \alpha > l + \beta$. Furthermore, let $D \subset \mathbb{R}^n$ be bounded and convex or bounded with a C^∞ -boundary. Then the identity map*

$$I: C^{k+\alpha}(D) \rightarrow C^{l+\beta}(D)$$

is compact.

PROOF. See [10, Section 28, Th. 7 and 8]. \square

The requirement that the boundary ∂D of D is C^∞ is too strong; see [10] for milder conditions.

2.2. Sobolev spaces

Let, for $1 \leq p < \infty$, $H^{m,p}(D)$ be the space of functions f in the open domain $D \subset \mathbb{R}^n$, all of whose distributional derivatives up to order m are functions in $L^p(D)$. Under the norm

$$\|f\|_{m,p} \stackrel{\text{def}}{=} \left\{ \sum_{|k| \leq m} \int_D |D^k f(x)|^p dx \right\}^{1/p}$$

$H^{m,p}(D)$ is a Banach space (see [9, Section 1]). $H^{m,2}(D)$ is a Hilbert space; the inner product is denoted by $(\cdot, \cdot)_m$. If $p = \infty$, $H^{m,\infty}(D)$ is the space of continuously differentiable functions f up to order m , such that the following norm is finite:

$$\|f\|_{m,\infty} \stackrel{\text{def}}{=} \sup_{\substack{x \in D \\ |k| \leq m}} |D^k f(x)|.$$

In this case we sometimes write $H^{m,\infty}(D) = C^m(D)$, and as in the last section it can be defined if D is not open too. The norm might also be denoted by $|\cdot|_m$.

It is only in places where all these spaces are used at the same time that one must be careful with the notation. However, if it is clear with which type of spaces one is dealing, the symbols denoting this type are not always written. For example, if one is concerned only with Sobolev spaces with $p = 2$, one often writes $H^m(D)$ with norm $\|\cdot\|_m$, or if only sup-norms occur the symbol ∞ may be omitted.

THEOREM 2.2. $C^\infty(\bar{D}) \cap H^{m,p}(D)$ is dense in $H^{m,p}(D)$, $1 \leq p \leq \infty$.

PROOF. See [9, Section 2]. \square

Theorem 2.2 is not true if $C^\infty(\bar{D})$ is replaced by $C_0^\infty(\bar{D})$, the space of C^∞ -functions with compact support in \bar{D} . Let $p = \infty$ and $D = \mathbb{R}^n$; then the closure of $C_0^\infty(\mathbb{R}^n)$ in $H^{m,\infty}(\mathbb{R}^n)$ consists of the bounded C^m -functions whose derivatives up to order m tend to zero at infinity. Hence, the function $f(x) \equiv 1 \in H^{m,\infty}(\mathbb{R}^n)$ does not belong to this closure. For $1 \leq p < \infty$, it is true that $C_0^\infty(\mathbb{R}^n)$ is dense in $H^{m,p}(\mathbb{R}^n)$ (see [9, Section 2]). In general, we define another type of Sobolev space $H_0^{m,p}(D)$ as the closure of $C_0^\infty(D)$ in $H^{m,p}(D)$. For example, let D be a bounded subset of \mathbb{R}^n , $p = 2$ and $m = 1$. If there is a function $f \in H^{1,2}(D)$ such that $(f, \phi)_1 = 0$ for all $\phi \in C_0^\infty(D)$, then $H_0^{1,2}(D) \neq H^{1,2}(D)$. This means

$$(f, \phi)_1 = \int_D f(x) \overline{\phi(x)} dx - \int_D f(x) \Delta \overline{\phi(x)} dx = 0.$$

Hence, f is a weak solution of the differential equation $f - \Delta f = 0$ in D .

The function $f(x) = \exp \sum_{i=1}^n x_i \zeta_i$, with ζ_i complex numbers satisfying $\sum_{i=1}^n \zeta_i^2 = 1$, is even a strong solution in $H^{1,2}(D)$.

A property of functions in $H_0^{m,p}(D)$, $p > 1$, where D has a smooth boundary (C^∞ -boundary) or is convex, is that if $f \in H_0^{m,p}(D) \cap C^{m-1}(\bar{D})$, then $D^k f(x) = 0$ for $x \in \partial D$ and $|k| \leq m-1$ (see [1, p.105]; the proof given there also holds for $p > 1$ instead of $p = 2$). Hence, if D is bounded and convex or with a smooth boundary, the function $f(x) \equiv 1 \in H^{m,p}(D)$ cannot belong to $H_0^{m,p}(D)$ if $m \geq 1$ and $p > 1$.

THEOREM 2.3. *Let $m > l \geq 0$. If D is a bounded domain, then the identity map*

$$I: H_0^{m,p}(D) \rightarrow H_0^{l,p}(D)$$

is compact for $1 \leq p \leq \infty$. If D is bounded and has a C^∞ -boundary, then

$$I: H^{m,p}(D) \rightarrow H^{l,p}(D)$$

is compact for $1 \leq p \leq \infty$.

PROOF. See [9, Section 4]. \square

If $p = \infty$, the last identity map of Theorem 2.3 is also compact when D is bounded and convex, which follows from Theorem 2.1.

Also in Theorem 2.3 the condition that the boundary of D is C^∞ can be released.

2.3. Connection between Hölder and Sobolev spaces

We now say how smooth functions in a Sobolev space are, by embedding Sobolev spaces continuously into Hölder spaces. This is called the Sobolev Lemma.

THEOREM 2.4. *Let $D \subset \mathbb{R}^n$ be convex or bounded with a C^∞ -boundary. Then the following identity mappings are continuous:*

$$\begin{aligned} I: H^{m,1}(D) &\rightarrow C^\ell(\bar{D}), & \text{for } m \geq \ell + n, \\ I: H^{m,p}(D) &\rightarrow C^{\ell+\alpha}(\bar{D}) & \text{for } 1 < p < \infty, m - \ell - n/p \geq \alpha > 0 \\ & & \text{and } \alpha < 1. \end{aligned}$$

For any domain D the following identity map is continuous

$$I: H_0^{m,p}(D) \rightarrow H_0^{\ell,\infty}(\bar{D}), \quad \begin{aligned} &\text{for } m \geq \ell + n \text{ if } p = 1, \text{ and} \\ &\text{for } m > \ell + n/p \text{ if } p > 1. \end{aligned}$$

PROOF. See [9, Section 3] and [5, Ch.II, th.38]. \square

As before, the conditions on D may be weakened.

The continuity means that there are constants C depending on n, m, ℓ, p and D such that for $f \in H^{m,p}(D)$

$$|f|_\ell \leq C \|f\|_{m,p}$$

in the first two cases, and

$$|f|_{m-1+\alpha} \leq C \|f\|_{m,p}$$

in the third case. The last map I shows that for $f \in H_0^{m,p}(D)$, we always have

$$D^k f(x) = 0, \quad x \in \partial D,$$

when $k < m - n/p$ if $p > 1$ or $k \leq m - n$ if $p = 1$. Therefore, the function $f(x) \equiv 1 \in H^{m,1}(D)$ cannot belong to $H_0^{m,1}(D)$ if $m \geq n$ and D is bounded.

3. EXISTENCE AND REGULARITY OF SOLUTIONS OF NONLINEAR PARABOLIC EQUATIONS

In this section we will find conditions for the function F in order that the equation (1.10) has a solution in D with u , u_t , u_x and u_{xx} continuous in D , where $D = (a,b) \times (0,s]$ for $a \geq -\infty$, $b \leq \infty$ and some $s > 0$. First, weak solutions (i.e., in a distributional sense) are constructed, and next we find conditions for F such that u , u_x , u_{xx} and u_t are continuous functions in D . Since (1.10) is in fact a perturbation of the heat equation, we use the Green's function of the heat equation. This method can be performed for more general equations too (see [3]). Another method, using Sobolev spaces, can be found in [4].

3.1. Existence of distributional solutions of the linear equation

The function

$$E(x,t) = \frac{1}{2\sqrt{\pi t}} \exp\left(-\frac{x^2}{4t}\right), \quad t > 0, \quad x \in \mathbb{R},$$

satisfies

$$(3.1) \quad \frac{\partial E}{\partial t} - \frac{\partial^2 E}{\partial x^2} = 0, \quad t > 0,$$

and in a distributional sense

$$(3.2) \quad \lim_{t \downarrow 0} E(x,t) = \delta(x).$$

Hence, if we denote by $E[t]$ the function $E[t](x) \stackrel{\text{def}}{=} E(x,t)$ on \mathbb{R} , a distributional solution of

$$\begin{aligned} u_t - u_{xx} &= 0, & t > 0, \\ u[0] &= \psi \end{aligned}$$

is given by

$$(3.3) \quad u(x,t) = (E[t]*\psi)(x),$$

where $*$ means the one-dimensional convolution with respect to the variable x . Here, ψ is a distribution on \mathbb{R} such that $E[t]*\psi$ exists for each $t > 0$. If $\psi \in L^\infty(\mathbb{R})$ with sup-norm $\|\psi\|$, we get explicitly

$$\begin{aligned}
 (3.4) \quad u(x,t) &= \frac{1}{2\sqrt{\pi t}} \int_{-\infty}^{\infty} \exp\left(-\frac{(x-\xi)^2}{4t}\right) \psi(\xi) d\xi \\
 &= \frac{1}{\sqrt{\pi}} \int_{-\infty}^{\infty} e^{-\eta^2} \psi(x+2\sqrt{t}\eta) d\eta.
 \end{aligned}$$

Hence,

$$(3.5) \quad \|u[t]\| \leq \|\psi\|, \quad t \geq 0.$$

To get estimates for the derivatives we need that for $t > 0$, $\ell \geq 0$, $m \geq 0$, and $\ell+m \geq 1$:

$$(3.6) \quad \int_{-\infty}^{\infty} \left(\frac{\partial}{\partial x}\right)^\ell \left(\frac{\partial}{\partial t}\right)^m E(x,t) dx = 0.$$

Then we may write

$$\begin{aligned}
 (3.7) \quad u_x(x,t) &= \frac{-1}{4t\sqrt{\pi t}} \int_{-\infty}^{\infty} (x-\xi) \exp\left(-\frac{(x-\xi)^2}{4t}\right) \psi(\xi) d\xi \\
 &= \frac{-1}{\sqrt{\pi t}} \int_{-\infty}^{\infty} \eta e^{-\eta^2} \{\psi(x+2\sqrt{t}\eta) - \psi(x)\} d\eta.
 \end{aligned}$$

If ψ is a continuous function in an interval (a,b) , then u is continuous on $\{\mathbb{R} \times (0, \infty)\} \cup \{(x,0) \mid a < x < b\}$. Assume now that ψ is uniformly Hölder continuous, i.e., it satisfies, for some γ with $0 < \gamma \leq 1$,

$$(3.8) \quad |\psi(x) - \psi(y)| \leq |\psi|_\gamma |x-y|^\gamma$$

for some constant $|\psi|_\gamma$. Then for some $K > 0$ ($K = 1$ if $\gamma = 1$) it follows from (3.7) that

$$(3.9) \quad \|u_x[t]\| \leq K |\psi|_\gamma t^{(\gamma-1)/2}, \quad t > 0,$$

and if $\gamma = 0$, i.e., if $\psi \in L^\infty(\mathbb{R})$, that

$$(3.10) \quad \|u_x[t]\| \leq \frac{1}{\sqrt{\pi}} \|\psi\| t^{-\frac{1}{2}}, \quad t > 0.$$

More generally, if ψ is k times continuously differentiable ($k \geq 0$), and $\partial^k \psi / \partial x^k$ satisfies

$$\left| \frac{\partial^k \psi}{\partial x^k}(x) - \frac{\partial^k \psi}{\partial x^k}(y) \right| \leq |\psi|_\gamma |x-y|^{\gamma-k}$$

for some number γ with $k \leq \gamma \leq k+1$ and for some constant $|\psi|_\gamma$, we get

$$(3.11) \quad \left\| \left(\frac{\partial}{\partial x} \right)^\ell \left(\frac{\partial}{\partial t} \right)^m u[t] \right\| \leq K_{\ell,m} |\psi|_\gamma t^{(\gamma-\ell-2m)/2}, \quad t > 0,$$

for some constants $K_{\ell,m} > 0$ depending on ℓ and m , as long as $\gamma-\ell-2m \leq 0$; otherwise (3.11) is bounded independently of t . In particular, $|\psi|_0$ denotes $\|\psi\|$ and $K_{0,0} = 1$.

Now we turn to the nonhomogeneous equation. Recall that, if $\theta(t) = 1$ for $t > 0$ and $\theta(t) = 0$ for $t \leq 0$, the distributional derivative with respect to t of the function $\theta(t)f(x,t)$ is given by

$$(3.12) \quad \frac{\partial \theta f}{\partial t}(x,t) = \{f(x,+0) - f(x,-0)\} \delta(t) + \theta(t) \frac{\partial f}{\partial t}(x,t).$$

We define the function

$$G(x,t) = \begin{cases} E(x,t), & t > 0, \quad x \in \mathbb{R}, \\ 0, & t \leq 0, \quad x \in \mathbb{R}, \end{cases}$$

which, according to (3.12), (3.2) and (3.1), satisfies

$$\begin{aligned} \frac{\partial G}{\partial t}(x,t) - \frac{\partial^2 G}{\partial x^2}(x,t) &= \delta(x)\delta(t) + \theta(t)\{E_t(x,t) - E_{xx}(x,t)\} \\ &= \delta(x,t). \end{aligned}$$

The function G is called the *Green's function* or the *fundamental solution of the one-dimensional heat equation*. The relation between the fundamental solutions G and E obtained here holds for more general initial value problems too (see [7]).

Let f be a distribution in \mathbb{R}^2 (the x,t -plane) such that $G*f$ exists; then a weak (i.e., distributional) solution of

$$v_t - v_{xx} = f$$

is given by

$$(3.13) \quad v = G*f,$$

where $*$ now means the two-dimensional convolution with respect to x and t . If f has its support in $\{(x,t) \mid t \geq 0\}$, then v does too, so that if, moreover, f is such that $G*f$ is a continuous function, then

$$v(x,0) = 0, \quad x \in \mathbb{R}.$$

For example, let, for some $T \leq \infty$ and any $0 < t < s < T$, $f \in L^\infty(\mathbb{R} \times [t,s])$ such that its sup-norm there satisfies

$$\|f\| \leq M_s t^{-\beta}$$

for some $M_s > 0$ depending on s and for some $\beta < 1$. For $t \leq 0$ we take f zero. Then (3.13) can be written explicitly

$$(3.14) \quad \begin{aligned} v(x,t) &= \theta(t) \int_0^t \int_{-\infty}^{\infty} \frac{1}{2\sqrt{\pi(t-\tau)}} \exp\left(\frac{-(x-\xi)^2}{4(t-\tau)}\right) f(\xi,\tau) d\xi d\tau \\ &= \theta(t) \int_0^t \int_{-\infty}^{\infty} \frac{1}{\sqrt{\pi}} e^{-\eta^2} f(x+2\sqrt{\tau}\eta, t-\tau) d\eta d\tau, \quad t < T. \end{aligned}$$

Furthermore, for $0 < t < T$,

$$(3.15) \quad \begin{aligned} v_x(x,t) &= \int_0^t \frac{1}{\sqrt{t-\tau}} \int_{-\infty}^{\infty} \frac{-1}{2\sqrt{\pi(t-\tau)}} \frac{x-\xi}{2\sqrt{t-\tau}} \exp\left(\frac{-(x-\xi)^2}{4(t-\tau)}\right) f(\xi,\tau) d\xi d\tau \\ &= \int_0^t \frac{1}{\sqrt{\tau}} \int_{-\infty}^{\infty} \frac{-1}{\sqrt{\pi}} \eta e^{-\eta^2} f(x+2\sqrt{\tau}\eta, t-\tau) d\eta d\tau. \end{aligned}$$

Differentiation of a function of $x^2/4t$ with respect to $|x|^\alpha$ yields another function of $x^2/4t$ times $t^{-\alpha/2}$, and differentiation of a function of $x^2/4t$ times $t^{-\ell}$ with respect to t^α yields another function of $x^2/4t$ times $t^{-\ell-\alpha}$. Applying the mean value theorem with respect to the variable $|x-\xi|^\alpha$, for some α with $0 < \alpha \leq 1$, to the first expression of (3.15), using

$$\left| |x-\xi|^\alpha - |y-\xi|^\alpha \right| \leq |x-y|^\alpha$$

and changing the variable as in the second expression of (3.15), we find

$$\begin{aligned}
 |v_x(x,t) - v_x(y,t)| &\leq |x-y|^\alpha \int_0^t \int_{-\infty}^{\infty} \frac{1}{\sqrt{\pi}} \tau^{-(1+\alpha)/2} \left\{ \frac{2^{1-\alpha}}{\alpha} |\eta|^{3-\alpha} + \right. \\
 &\quad \left. + \frac{2^{-\alpha}}{\alpha} |\eta|^{1-\alpha} \right\} e^{-\eta^2} \cdot |f(\sigma x + (1-\sigma)y + 2\sqrt{\tau} \eta, t-\tau)| d\eta d\tau \\
 &\leq K|x-y|^\alpha t^{\frac{1}{2}-\alpha/2-\beta} M_s,
 \end{aligned}$$

for $0 < t \leq s$ and $x, y \in \mathbb{R}$, where σ is a function of η and τ between 0 and 1. Similarly, for $0 < t \leq t_1 < t_2 \leq s$,

$$\begin{aligned}
 |v_x(x,t_1) - v_x(x,t_2)| &\leq (t_2 - t_1)^\alpha \int_0^{t_1} \int_{-\infty}^{\infty} \frac{\tau^{-(\alpha+\frac{1}{2})}}{\sqrt{\pi}} |\eta|^3 + \frac{3}{2\alpha} |\eta| e^{-\eta^2} \cdot \\
 &\quad \cdot |f(x+2\sqrt{\tau} \eta, \sigma t_1 + (1-\sigma)t_2 - \tau)| d\eta d\tau + \\
 &\quad + \int_{t_1}^{t_2} \int_{-\infty}^{\infty} \frac{\tau^{-\frac{1}{2}}}{\sqrt{\pi}} |\eta| e^{-\eta^2} |f(x+2\sqrt{\tau} \eta, t_2 - \tau)| d\eta d\tau \\
 &\leq K(t_2 - t_1)^\alpha t^{\frac{1}{2}-\alpha-\beta} M_s + K(t_2 - t_1)^{1-\beta} t^{-\frac{1}{2}} M_s,
 \end{aligned}$$

or, if $\beta < \frac{1}{2}$, the last term can also be majorized by $K(t_2 - t_1)^{\frac{1}{2}-\beta} M_s$, and

$$|v(x,t_1) - v(x,t_2)| \leq K(t_2 - t_1)^\alpha t^{1-\alpha-\beta} M_s + K(t_2 - t_1)^{1-\beta} M_s.$$

Hence v and v_x are Hölder continuous functions. Thus we have obtained the following lemma.

LEMMA 3.1. *Let f be a function on $\mathbb{R} \times (0, T)$, where $0 < T \leq \infty$, such that for any positive $s < T$ and $0 < t < s$,*

$$(3.16) \quad \sup_{\substack{x \in \mathbb{R} \\ t \leq \tau \leq s}} |f(x, \tau)| \leq M t^{-\beta}$$

for some $M > 0$ depending on s and for some nonnegative $\beta < 1$. Then the equation

$$v_t - v_{xx} = f, \quad x \in \mathbb{R}, \quad 0 < t < T,$$

has a weak solution v (3.13), which is a continuous function of x and t . This function is also continuous for $t = 0$ and

$$(3.17) \quad v(x,0) = 0, \quad x \in \mathbb{R}.$$

Furthermore, v and v_x are Hölder continuous with respect to x and t , and the sup and Hölder norms on the domain $\mathbb{R} \times [t,s]$ satisfy

$$(3.18) \quad \begin{cases} \|v\| & \leq \frac{s^{1-\beta}}{1-\beta} M, \\ \|v_x\| & \leq \frac{\sqrt{6}}{1-\beta} \max\{t^{\frac{1}{2}-\beta}, s^{\frac{1}{2}-\beta}\} M, \end{cases}$$

$$(3.19) \quad \begin{cases} |v|_{1-\beta} & \leq KM, \\ |v_x|_{\alpha} & \leq Kt^{-\frac{1}{2}} M, \quad \text{with } \alpha < \frac{1}{2}, \alpha \leq 1-\beta, \text{ and} \\ |v_x|_{\alpha} & \leq KM, \quad \text{with } \alpha < \frac{1}{2}, \alpha \leq \frac{1}{2}-\beta, \text{ if } \beta < \frac{1}{2} \end{cases}$$

for some positive constant K .

3.2. Existence of distributional solutions of the nonlinear equation

We consider the nonlinear equation for $x \in \mathbb{R}$, $0 < t < T$, where $T \leq \infty$,

$$(3.20) \quad \begin{cases} u_t(x,t) - u_{xx}(x,t) - F(x,t,u(x,t),u_x(x,t)) = 0, \\ u[0] = \psi. \end{cases}$$

The following conditions are imposed upon the functions ψ and F : either case (a): ψ is an L^∞ -function on \mathbb{R} and, for any positive $s < T$, F is a bounded function on $\mathbb{R} \times (0,s] \times S$, where S is compact in \mathbb{R}^2 , whose sup-norm satisfies

$$\sup\{|F(x,t,u,p)| \mid x \in \mathbb{R}, 0 < t \leq s, |u| \leq N, p \in \mathbb{R}\} \leq M_{s,N} (1+|p|^{2\beta})$$

for some $M_{s,N} > 0$ depending on s and N and for some $\beta < 1$; moreover, F is continuous with respect to u and p , uniformly in the following sense: for every $\varepsilon > 0$, every compact set S in \mathbb{R}^2 and every $0 < s < T$, there is a $\delta > 0$ such that for all $(u,p) \in S$ and $(v,q) \in S$ with $|u-v| + |p-q| < \delta$, and for all $t > 0$,

$$(3.21) \quad \sup_{\substack{x \in \mathbb{R} \\ t \leq \tau \leq s}} |F(x, \tau, u, \tau^{-\frac{1}{2}}p) - F(x, \tau, v, \tau^{-\frac{1}{2}}q)| \leq t^{-\beta} \varepsilon;$$

or

case (b): ψ is a Lipschitz continuous function uniformly in \mathbb{R} , thus (3.8) is satisfied for $\gamma = 1$, and F is a bounded function on $\mathbb{R} \times [t,s] \times S$ for every $0 < t < s < T$ and S compact in \mathbb{R}^2 , such that

$$\sup\{|F(x, \tau, u, p)| \mid x \in \mathbb{R}, t \leq \tau \leq s, (u, p) \in S\} \leq M_{s,S} t^{-\tilde{\beta}}$$

for some $M_{s,S} > 0$ depending on s and S and for some $\tilde{\beta} < \frac{1}{2}$; moreover, F is continuous with respect to u and p uniformly in the following sense: for every $\varepsilon > 0$, every compact set S in \mathbb{R}^2 and every $0 < s < T$, there is a $\delta > 0$ such that for all $(u,p) \in S$ and $(v,q) \in S$ with $|u-v| + |p-q| < \delta$, and for all $t > 0$,

$$(3.21) \quad \sup_{\substack{x \in \mathbb{R} \\ t \leq \tau \leq s}} |F(x, \tau, u, p) - F(x, \tau, v, q)| \leq t^{-\tilde{\beta}} \varepsilon.$$

With the aid of the functions (3.3) and (3.13) we will obtain an $s > 0$ and a distributional solution u for $0 < t < s$, first for x in a finite interval. We will also find a condition for F such that the solution extends, as a continuous function, to the domain $\mathbb{R} \times (0, T)$.

Fix $T_1 < T$; let M be a positive number such that in case (a)

$$(3.22) \quad \sup\{|F(x, \tau, u, \tau^{-\frac{1}{2}}p)| \mid x \in \mathbb{R}, t \leq \tau \leq T_1, |u| + |p| \leq (1 + \pi^{-\frac{1}{2}})\|\psi\| + 1\} \leq Mt^{-\beta},$$

or in case (b)

$$(3.22) \quad \sup\{|F(x, \tau, u, p)| \mid x \in \mathbb{R}, t \leq \tau \leq T_1, |u| + |p| \leq \|\psi\| + |\psi|_1 + 1\} \leq Mt^{-\tilde{\beta}};$$

and let $s \leq T_1$ be a positive number such that in case (a)

$$(3.23) \quad \frac{1+\sqrt{6}}{1-\beta} s^{1-\beta} M \leq 1,$$

or in case (b)

$$(3.23) \quad \frac{s^{1-\tilde{\beta}} + \sqrt{6} s^{\frac{1}{2}-\tilde{\beta}}}{1-\tilde{\beta}} M \leq 1.$$

We will obtain distributional solutions, but as we are interested in classical solutions finally (see Section 3.3) we consider functions u which are continuous on that part of the boundary $\{(x,t) \mid t=0\}$ where ψ is continuous. In case (b) this is the whole x -axis and in case (a) we may think of ψ as being piecewise continuous.

Let B be the Banach space of continuous functions u on $\{(-N,N) \times (0,s]\} \cup \{(x,0) \mid x \in (-N,N), \psi(x) \text{ is continuous}\}$, which are continuously differentiable with respect to x on $(-N,N) \times (0,s]$ such that the following norm is finite:

in case (a)

$$\|u\|_B \stackrel{\text{def}}{=} \sup_{\substack{-N < x < N \\ 0 < t \leq s}} |u(x,t)| + \sup_{\substack{-N < x < N \\ 0 < t \leq s}} \sqrt{t} |u_x(x,t)|,$$

and in case (b)

$$\|u\|_B \stackrel{\text{def}}{=} \sup_{\substack{-N < x < N \\ 0 < t \leq s}} |u(x,t)| + \sup_{\substack{-N < x < N \\ 0 < t \leq s}} |u_x(x,t)|.$$

That the first space is a Banach space can be shown as in [9, Section 1], and the second space is the Sobolev space $H^{1,\infty}((-N,N) \times (0,s])$. Let K be the closed, bounded and convex set in B , in case (a) defined by

$$K \stackrel{\text{def}}{=} \{u \in B \mid \|u\|_B \leq (1+\pi^{-\frac{1}{2}})\|\psi\| + 1\},$$

and in case (b) by

$$K \stackrel{\text{def}}{=} \{u \in B \mid \|u\|_B \leq \|\psi\| + |\psi|_1 + 1\}.$$

We define a map A from K into B by

$$Au = E[t]*\psi + G*F[u, u_x]_N,$$

where $F[u, u_x]_N$ is the function $F(x, t, u(x, t), u_x(x, t))$ on $(-N, N) \times (0, s]$, and $F[u, u_x]_N$ vanishes if $x \notin (-N, N)$; here the first convolution is with respect to x and the second with respect to x and t . Since (3.22) implies (3.16), (3.17) ensures that $u[0] = \psi$, and furthermore from (3.5), (3.10) or (3.9) with $\gamma = 1$, (3.18) and (3.23), we derive

$$\begin{aligned} \|Au\|_B &\leq \|\psi\| + \frac{s^{1-\beta}}{1-\beta} M + \frac{1}{\sqrt{\pi}} \|\psi\| + \frac{\sqrt{6}}{1-\beta} s^{1-\beta} M \leq (1+\pi^{-\frac{1}{2}})\|\psi\| + 1, \text{ case (a)} \\ (3.24) \quad \|Au\|_B &\leq \|\psi\| + \frac{s^{1-\tilde{\beta}}}{1-\tilde{\beta}} M + |\psi|_1 + \frac{\sqrt{6}}{1-\tilde{\beta}} s^{\frac{1}{2}-\tilde{\beta}} M \leq \|\psi\| + |\psi|_1 + 1, \text{ case (b)}. \end{aligned}$$

Hence A is a map from K into K, which is continuous, because by (3.21) and (3.18) we can find for every $\epsilon > 0$ a $\delta > 0$ such that for $u \in K$ and $v \in K$ with $\|u-v\|_B < \delta$,

$$\|Au-Av\|_B \leq \sup\left\{ \frac{t^{1-\beta} + \sqrt{6} t^{1-\beta}}{1-\beta} \text{ or } \frac{t^{1-\tilde{\beta}} + \sqrt{6} t^{\frac{1}{2}-\tilde{\beta}}}{1-\tilde{\beta}} \mid 0 < t \leq s \right\} \epsilon.$$

Furthermore, Theorem 2.1 and (3.19) ensure that the set $\{Au-E[t]*\psi \mid u \in K\}$ is compact in B, and hence the map A is compact. By Schauder's Fixed Point Theorem [8, Chapter VIII] there is a fixed point u_N in K with $u_N = Au_N$, and clearly u_N is a (weak) solution of (3.10) in $(-N, N) \times (0, s]$.

The function $v_N = G*F[u_N, \partial u_N / \partial x]_N$ is defined for all $x \in \mathbb{R}$, $0 \leq t \leq s$. Since in the above all the estimates are independent of N, (3.19) yields that the sequence $\{v_N\}_{N=1}^\infty$ is bounded on $\mathbb{R} \times [0, s]$ in some Hölder norm. Therefore, according to Theorem 2.1, there is a uniformly convergent subsequence which converges to a uniformly Hölder continuous function v (with a smaller Hölder exponent). Since also, by (3.19), $\{\partial v_N / \partial x\}_{N=1}^\infty$ is bounded in some Hölder norm on $\mathbb{R} \times [t, s]$, for every $0 < t < s$, $\partial v / \partial x$ exists and is a Hölder continuous function in $\mathbb{R} \times (0, s]$. Now we have, in any compact subset of $\mathbb{R} \times (0, s]$ as $N \rightarrow \infty$, on the one hand by (3.1)

$$\left(\frac{\partial}{\partial t} - \frac{\partial^2}{\partial x^2} \right) v_N \rightarrow \left(\frac{\partial}{\partial t} - \frac{\partial^2}{\partial x^2} \right) (v + E[t]*\psi) \quad \text{weakly,}$$

and on the other hand

$$\begin{aligned} \left(\frac{\partial}{\partial t} - \frac{\partial}{\partial x^2} \right) v_N &= F[v_N + E[t]*\psi, \frac{\partial}{\partial x}(v_N + E[t]*\psi)] \rightarrow \\ &\rightarrow F[v + E[t]*\psi, \frac{\partial}{\partial x}(v + E[t]*\psi)] \quad \text{weakly.} \end{aligned}$$

Hence, $u(x,t) = v(x,t) + (E[t]*\psi)(x)$ is a weak solution of (3.20) in $\mathbb{R} \times (0,s]$, which by the above considerations can be written as

$$(3.25) \quad u = E[t]*\psi + G*F[u, u_x].$$

THEOREM 3.2. *Let ψ and F satisfy either the conditions of case (a) or the conditions of case (b), listed at the beginning of this section. Then there exists an s , $0 < s < T$, such that (3.20) has a distributional solution in the domain $\mathbb{R} \times (0,s]$ which is a bounded continuous function on $\{\mathbb{R} \times (0,s]\} \cup \{(x,0) \mid \psi(x) \text{ is continuous}\}$, and which is continuously differentiable with respect to x in $\mathbb{R} \times (0,s]$.*

In [2] F is required to be uniformly Lipschitz continuous in x and u , and F does not depend on p . Then the existence is shown by successive approximation (in fact, the Banach contraction principle). See [3, Chapter IV, §2 & Chapter V] for a more general treatment of the method discussed here.

Theorem 3.2 only gives a solution for t with $0 < t \leq s < T$. If F is bounded on $\mathbb{R} \times (0, T_1] \times \mathbb{R}^2$ for any $T_1 < T$, repeating the above method gives a solution for t with $s < t \leq 2s$ (if $2s \leq T_1 < T$), because then (3.23) yields the same s . So in that case we finally get a solution for $0 < t < T$. Now we investigate more general conditions on F in order that the solution extends as a continuous function to the domain $\mathbb{R} \times (0,T)$, where $0 < T \leq \infty$. Besides the conditions imposed upon F by Theorem 3.2, let F satisfy for every $s > 0$ and $s < T_1 < T$

$$(3.26) \quad \sup\{|F(x,t,u,p)| \mid x \in \mathbb{R}, \quad s \leq t \leq T_1, (u,p) \in \mathbb{R}^2\} \leq K(1+|u|+|p|)$$

for some $K > 0$ depending on s and T_1 . After one application of Theorem 3.2 we have a solution u_0 in $\mathbb{R} \times (0,s_0]$ for some $s_0 > 0$. Let u_1 be the solution in $\mathbb{R} \times (s_0+s_1+\dots+s_{i-1}, s_0+\dots+s_{i-1}+s_i]$ after application of Theorem 3.2 another i times. Since $u_{i-1}(x, s_0+\dots+s_{i-1})$ is differentiable with respect to

x , we use the method of case (b) with $\beta = 0$. However, the i^{th} time we apply Theorem 3.2 we take the supremum in (3.22) as $|u| + |p| \leq \|u_{i-1}\|_B + 2^{i-1}$, and instead of (3.23) we take $s_i \leq 1$ such that

$$\sqrt{s_i} \leq \frac{2^{i-1}}{(1+\sqrt{6})M}.$$

By (3.26) this means that we must have

$$\sqrt{s_i} \leq \frac{2^{i-1}}{(1+\sqrt{6})K(\|u_{i-1}\|_B + 2^{i-1} + 1)}.$$

As in (3.24), $\|u_i\|_B \leq \|u_{i-1}\|_B + 2^{i-1}$, $i = 1, 2, \dots$, so that in the above we may choose

$$\begin{aligned} \sqrt{s_i} &= \frac{1}{(1+\sqrt{6})K(2+\|u_0\|_B)} \leq \frac{1}{(1+\sqrt{6})K} \frac{2^{i-1}}{(2^i + \|u_0\|_B)} \leq \dots \leq \\ &\leq \frac{1}{(1+\sqrt{6})K} \frac{2^{i-1}}{(\|u_k\|_B + 2^i - 2 - \dots - 2^{k-1})} \leq \dots \leq \frac{2^{i-1}}{(1+\sqrt{6})K(\|u_{i-1}\|_B + 2^{i-1} + 1)}. \end{aligned}$$

Thus s_i is independent of i , and we can reach any $T_1 < T$ after a finite number of steps.

THEOREM 3.3. *Let ψ and F be as in Theorem 3.2, and moreover let F satisfy (3.26). Then (3.20) has a distributional solution in $\mathbb{R} \times (0, T)$ which is a continuous function in $\{\mathbb{R} \times (0, T)\} \cup \{(x, 0) \mid \psi(x) \text{ is continuous}\}$ bounded in $\mathbb{R} \times (0, T_1]$ for any $T_1 < T$, and which is continuously differentiable with respect to x in $\mathbb{R} \times (0, T)$.*

In particular, if $T = \infty$, (3.20) has a solution which extends to infinity, i.e., in the domain $\mathbb{R} \times (0, \infty)$. For example, let

$$\begin{aligned} u_t - u_{xx} &= -m(u^{m+1})^{1/m}, \\ u(x, 0) &= -1, \end{aligned}$$

where m is any positive odd integer. In this case (3.26) is not satisfied, and the unique solution

$$u(x, t) = (t-1)^{-m}$$

is a continuous function only in $\mathbb{R} \times [0, 1)$.

We now consider the finite interval (a,b) . Let ψ be a bounded function on $[a,b]$, and let F be a function on $(a,b) \times (0,T) \times \mathbb{R}^2$. We can extend the domains of definition of ψ and F so as to include all $x \in \mathbb{R}$ by reflecting ψ and F even or odd as a function of x and by taking F zero in the points x where it is not already defined in that way. The solution of (3.20) obtained by Theorems 3.2 or 3.3 is a continuously differentiable function with respect to x , so that in the first case it satisfies $u_x(a+k(b-a),t) = 0$, $0 < t \leq s$, $k = 0, \pm 1, \dots$, and in the second case $u(a+k(b-a),t) = 0$.

THEOREM 3.4. *Let the functions ψ on $[a,b]$ and F on $(a,b) \times (0,T) \times \mathbb{R}^2$ satisfy the conditions of Theorem 3.2, case (a), where in the estimates x ranges over (a,b) instead of over \mathbb{R} . Then the problems*

$$\begin{aligned} u_t(x,t) - u_{xx}(x,t) - F(x,t,u(x,t),u_x(x,t)) &= 0, \quad a < x < b, \quad 0 < t < T, \\ u[0] &= \psi, \\ u(a,t) = u(b,t) = 0 \quad \text{or} \quad u_x(a,t) = u_x(b,t) &= 0, \quad 0 < t < T, \end{aligned}$$

have distributional solutions on $[a,b] \times [0,s]$, for some $s < T$, which are bounded continuous functions on $\{[a,b] \times (0,s]\} \cup \{(x,0) \mid \psi(x) \text{ is continuous}\}$, and which are continuously differentiable with respect to x in $[a,b] \times (0,s]$. The same is true if the conditions of Theorem 3.2, case (b), are satisfied for $x \in (a,b)$, provided that the odd or even continuation of ψ is uniformly Lipschitz continuous on \mathbb{R} . If, moreover, F satisfies (3.26) as x ranges over (a,b) , then the solutions extend to the domain $[a,b] \times [0,T]$.

3.3. Regularity

In this section we will find conditions for ψ and F such that the solutions of Theorems 3.2, 3.3 and 3.4 are *classical solutions*, i.e., the differential equation is satisfied pointwise.

In the last section $u[t]$ tended to ψ in a *distributional sense* as $t \downarrow 0$, i.e.,

$$(3.27) \quad \lim_{t \downarrow 0} \int u(x,t) \phi(x) dx = \int \psi(x) \phi(x) dx$$

for any C^∞ -function ϕ with compact support. If ψ is continuous in an open interval (a,b) , we have seen that u is continuous in $\{\mathbb{R} \times (0,s]\} \cup \{(x,0) \mid a < x < b\}$. Then (3.27) implies that for every $x \in (a,b)$, $\lim_{t \downarrow 0} u(x,t) =$

$\psi(x)$, so that ψ is a classical initial value in (a,b) . Hence, ψ needs to be continuous or piecewise continuous, where in the last case (3.27) holds and the pointwise limit for $t \downarrow 0$ equals ψ in all the points of continuity of ψ .

If a function is differentiable, its derivative equals the distributional derivative. If two functions are equal as distributions, they may differ on a set of measure zero; hence, if two continuous functions are equal as distributions, they are also equal as functions. Therefore, a distributional solution of a differential equation with continuous coefficients is a classical solution if its distributional derivatives are continuous functions. Thus we assume that F is continuous, actually Hölder continuous, and we will show that u_t and u_{xx} are (Hölder) continuous functions.

The solution (3.3) of the homogeneous linear heat equation is a C^∞ -function for $t > 0$ (cf. (3.11)). Now consider the weak solution (3.14) of the nonhomogeneous linear equation. Let, besides the condition of Lemma 3.1, f be Hölder continuous uniformly in the following sense: for some $\beta < 1$ and $\alpha > 0$, for all $0 < \delta < T_1 < T$,

$$(3.28) \quad \begin{aligned} |f(x,t) - f(y,t)| &\leq Kt^{-\beta}|x-y|^\alpha, & 0 < t \leq T_1 < T, \quad x,y \in (a,b), \\ |f(x,t_1) - f(x,t_2)| &\leq K_\delta|t_1-t_2|^\alpha, & t_1,t_2 \in [\delta,T_1], \quad x \in (a,b), \end{aligned}$$

where the positive constants K and K_δ depend on T_1 and on T_1 and δ , respectively, and where $a = -\infty$ and $b = \infty$. By virtue of (3.6), the distributional second derivative v_{xx} of the function v of Lemma 3.1 may be written as

$$(3.29) \quad v_{xx}(x,t) = \int_0^t \int_{-\infty}^{\infty} \left\{ -\frac{1}{2} + \frac{(x-\xi)^2}{4(t-\tau)} \right\} \exp\left(\frac{-(x-\xi)^2}{4(t-\tau)}\right) \frac{1}{2\sqrt{\pi(t-\tau)}} \{f(\xi,\tau) - f(x,\tau)\} d\xi d\tau,$$

provided that this expression exists. Using (3.28) we find that the absolute value can be majorized by

$$(3.30) \quad \begin{aligned} K \int_0^t \int_{-\infty}^{\infty} \left\{ \frac{1}{2} + \frac{(x-\xi)^2}{4\tau} \right\} \frac{1}{2\sqrt{\pi\tau}} \exp\left(\frac{-(x-\xi)^2}{4\tau}\right) \frac{|x-\xi|^\alpha}{\tau(t-\tau)^\beta} d\xi d\tau = \\ = K \int_0^t \int_{-\infty}^{\infty} \left\{ \frac{1}{2} + \eta^2 \right\} |\eta|^\alpha \frac{2^\alpha}{\sqrt{\pi}} e^{-\eta^2} \frac{\tau^{\frac{1}{2}\alpha-1}}{(t-\tau)^\beta} d\eta d\tau \leq K't^{\frac{1}{2}\alpha-\beta}. \end{aligned}$$

Hence the expression (3.29) exists and, as before, differentiating (3.29) with respect to a sufficiently small positive power of $t - \tau$ yields that v_{xx} is a Hölder continuous function with respect to t , uniformly in $[\delta, T_1]$ for any $0 < \delta < T_1 < T$. From the differential equation

$$(3.31) \quad v_t(x, t) = v_{xx}(x, t) + f(x, t),$$

and from (3.28), it follows that v_t is a Hölder continuous function with respect to t in $(a, b) \times (0, T)$ too.

Next we investigate the continuity with respect to x . In a distributional sense we have

$$\begin{aligned} \int_0^t \frac{\partial}{\partial \tau} \left\{ (G[\tau] * f[\tau])(x) \right\} d\tau &= (G[t] * f[t])(x) - (\delta * f[t])(x) \\ &= (G[t] * f[t])(x) - f(x, t); \end{aligned}$$

here the convolution is taken with respect to the x -variable. Hence, by (3.31), for $t > 0$ we get in a distributional sense

$$(3.32) \quad \begin{aligned} v_t(x, t) &= (G[t] * f[t])(x) + \\ &+ \int_0^t \int_{-\infty}^{\infty} \left\{ -\frac{1}{2} + \frac{(x-\xi)^2}{4(t-\tau)} \right\} \exp\left(\frac{-(x-\xi)^2}{4(t-\tau)}\right) \frac{1}{2\sqrt{\pi(t-\tau)}(t-\tau)} \\ &\quad \{f(\xi, \tau) - f(\xi, t)\} d\xi d\tau, \end{aligned}$$

provided that this expression exists. By (3.11) the first term is a Hölder continuous function with respect to x , uniformly in $\mathbb{R} \times [\delta, T_1]$. In view of (3.28) and (3.16) the absolute value of the second term can be majorized by

$$\begin{aligned} &\int_0^\delta \int_{-\infty}^{\infty} \left\{ \frac{1}{2} + \frac{(x-\xi)^2}{4(t-\tau)} \right\} \exp\left(\frac{-(x-\xi)^2}{4(t-\tau)}\right) \frac{1}{2\sqrt{\pi(t-\tau)}(t-\tau)} \left\{ \frac{M}{\tau^\beta} + \frac{M}{t} \right\} d\xi d\tau + \\ &+ K_\delta \int_\delta^t \int_{-\infty}^{\infty} \left\{ \frac{1}{2} + \frac{(x-\xi)^2}{4\tau} \right\} \exp\left(\frac{-(x-\xi)^2}{4\tau}\right) \frac{\tau^{\alpha-1}}{2\sqrt{\pi\tau}} d\xi d\tau \leq \\ &\leq K' \int_0^\delta \frac{\tau^{-\beta}}{t-\tau} d\tau + K'_\delta \int_0^t \tau^{\alpha-1} d\tau \leq K''_\delta \frac{1}{t-\delta}, \end{aligned}$$

where $0 < \delta < t$. Therefore, the expression (3.32) exists and, as before, differentiating the second term in (3.32) with respect to a sufficiently small positive power of $|x-\xi|$ yields that v_t is a Hölder continuous function with respect to x , uniformly in $\mathbb{R} \times [\delta, T_1]$ for any $0 < \delta < T_1 < T$. By (3.31) and (3.28) v_{xx} is also a Hölder continuous function with respect to x . Thus we have shown that v_{xx} and v_t are Hölder continuous functions in $\mathbb{R} \times (0, T)$, uniformly in $\mathbb{R} \times (\delta, T_1)$ for any $0 < \delta < T_1 < T$.

In Chapter I, v_{xxx} and v_{xt} were needed. It is clear that they are equal to the expressions (3.29) and (3.32), respectively, with f replaced by f_x , provided that f_x is Hölder continuous as in (3.28). Hence, in that case, v_{xxx} and v_{xt} are Hölder continuous functions.

Now let f be piecewise continuous as a function of x and let it satisfy (3.28) for any interval (a, b) such that f is continuous in $(a, b) \times (0, T)$. The differential equation holds classically at the points of continuity if v_t and v_{xx} are continuous in $(a, b) \times (0, T)$. For $x \in (a, b)$, $0 < t < T_1$, we may write (3.29) as

$$v_{xx}(x, t) = \int_0^t \int_a^b \left\{ -\frac{1}{2} + \frac{(x-\xi)^2}{4(t-\tau)} \right\} \exp\left(\frac{-(x-\xi)^2}{4(t-\tau)}\right) \frac{1}{2\sqrt{\pi(t-\tau)}(t-\tau)} \{f(\xi, \tau) - f(x, \tau)\} d\xi d\tau + \int_0^t \left[\int_{-\infty}^a + \int_b^{\infty} \right] \left\{ -\frac{1}{2} + \frac{(x-\xi)^2}{4(t-\tau)} \right\} \exp\left(\frac{-(x-\xi)^2}{4(t-\tau)}\right) \frac{1}{2\sqrt{\pi(t-\tau)}(t-\tau)} \{f(\xi, \tau) - f(x, \tau)\} d\xi d\tau.$$

The absolute value of the first term can be majorized by (3.30), and that of the second term by

$$MC \int_0^t \exp\left(-\frac{\alpha}{2\sqrt{\tau}}\right) \tau^{-3/2} (t-\tau)^{-\beta} d\tau = MC t^{-\beta} \int_{1/t}^{\infty} \frac{\tau^{\beta-1/2}}{(\tau-1/t)^\beta} \exp\left(-\frac{\alpha}{2\sqrt{\tau}}\right) d\tau \leq K(\alpha) < \infty,$$

where $\alpha = \min\{x-a, b-x\}$, C some positive constant, and where M and β are determined by (3.16). As before it is shown that v_{xx} is Hölder continuous with respect to t , uniformly in $[c, d] \times [\delta, T_1]$ for all $a < c < d < b$ and $0 < \delta < T_1 < T$. Similarly, using (3.32), v_t is treated, yielding that it is Hölder continuous with respect to x . Hence, v_{xx} and v_t are Hölder continuous functions, uniformly in any $[c, d] \times [\delta, T_1]$. If f is piecewise differentiable with

respect to x and if f_x satisfies (3.28), then v_{xxx} and v_{xt} are (Hölder) continuous in $(a,b) \times (0,T)$. Moreover, v_{xx} is integrable with respect to x from a to b for any $t \in (0,T)$, because v_x , which is a continuous function on $[a,b] \times (0,T)$, is a primitive.

For more detailed estimates of higher order derivatives, and also for the continuity of these on $[a,b] \times (0,T)$, see [3, Chapter IV, §1 and 2].

We now turn to the nonlinear equation (3.20). As before, we consider two cases: case (a), where ψ is an L^∞ -function, and case (b), where ψ is uniformly Lipschitz continuous.

THEOREM 3.5. *Let ψ and F be as in Theorem 3.2, 3.3 or 3.4, and moreover let F be Hölder continuous or piecewise Hölder continuous as a function of x , and Hölder continuous in the remaining variables, uniformly in the following sense: for some $\beta < 1$ and $\alpha > 0$, for all $0 < \delta < T_1 < T$, all compact subsets S of \mathbb{R}^2 and all $a < b$ such that F is continuous in $(a,b) \times (0,T) \times \mathbb{R}^2$, $a \geq -\infty$, $b \leq \infty$, $0 < T \leq \infty$,*

$$(3.33) \quad \begin{cases} |F(x,t,u,t^\gamma p) - F(y,t,u,t^\gamma p)| \leq Kt^{-\beta} |x-y|^\alpha, & 0 < t \leq T_1, (x,y) \in (a,b), (u,p) \in S, \\ |F(x,t_1,u,p) - F(x,t_2,u,p)| \leq K_\delta |t_1 - t_2|^\alpha, & t_1, t_2 \in [\delta, T_1], x \in (a,b), (u,p) \in S, \\ |F(x,t,u,t^\gamma p) - F(x,t,v,t^\gamma p)| \leq Kt^{-\beta} |u-v|^\alpha, & 0 < t \leq T_1, x \in (a,b), (u,p), (v,p) \in S, \\ |F(x,t,u,t^\gamma p) - F(x,t,u,t^\gamma q)| \leq Kt^{-\beta} |p-q|^\alpha, & 0 < t \leq T_1, x \in (a,b), (u,p), (u,q) \in S, \end{cases}$$

where $\gamma = -\frac{1}{2}$ in case (a) and $\gamma = 0$ in case (b), and where the positive constants K and K_δ depend on T_1 and on T_1 and δ , respectively. Then the distributional solutions u of Theorems 3.2, 3.3 or 3.4 are classical solutions in the points of continuity and u_t and u_{xx} are Hölder continuous functions, uniformly in $\mathbb{R} \times [\delta, T_1]$ if $a = -\infty$ and $b = \infty$, and in $[c,d] \times [\delta, T_1]$ if $a > -\infty$ and $b < \infty$, for all $0 < \delta < T_1 < T$ and $a < c < d < b$.

PROOF. From (3.25), (3.19) and (3.11) it follows that u and $t^{-\gamma} u_x$ are bounded functions, and that u and u_x satisfy (3.28) with $\beta = 1$. For $x, y \in (a,b)$ and $0 < t \leq T_1$, the function $F[u, u_x]$ satisfies for any positive α smaller than or equal to the α of (3.33):

$$\begin{aligned} |F[u, u_x](x,t) - F[u, u_x](y,t)| &\leq |F(x,t,u(x,t), u_x(x,t)) - F(y,t,u(x,t), u_x(x,t))| + \\ &\quad + |F(y,t,u(x,t), u_x(x,t)) - F(y,t,u(y,t), u_x(x,t))| \\ &\quad + |F(y,t,u(y,t), u_x(x,t)) - F(y,t,u(y,t), u_x(y,t))| \\ &\leq Kt^{-\beta} |x-y|^\alpha + Kt^{-\beta} |u(x,t) - u(y,t)|^\alpha + Kt^{-\beta} |u_x(x,t) - u_x(y,t)|^\alpha \\ &\leq Kt^{-\beta} |x-y|^\alpha + K't^{-\beta} (t^{-\frac{1}{2}} |x-y|)^\alpha + K't^{-\beta} (t^{-1} |x-y|)^\alpha. \end{aligned}$$

Similarly, for $x \in (a,b)$ and $t_1, t_2 \in [\delta, T_1]$:

$$\begin{aligned} & |F[u, u_x](x, t_1) - F[u, u_x](x, t_2)| \leq \\ & \leq K_\delta |t_1 - t_2|^\alpha + K\delta^{-\beta} |u(x, t_1) - u(x, t_2)|^\alpha + K\delta^{-\beta} |u_x(x, t_1) - u_x(x, t_2)|^\alpha \\ & \leq K_\delta |t_1 - t_2|^\alpha + K'_\delta |t_1 - t_2|^\alpha + K''_\delta |t_1 - t_2|^\alpha. \end{aligned}$$

Hence, if in the first inequality $\alpha < 1 - \beta$, $F[u, u_x]$ satisfies (3.28) and the theorem follows from the considerations at the beginning of this section.

For the solutions u of Theorem 3.3 in the domain $\mathbb{R} \times (s_i, s_{i+1}]$, we have

$$u(x, t) = (E[t - s_i] * u[s_i])(x) + \int_0^{t - s_i} \int_{-\infty}^{\infty} G(t - s_i - \tau, x - \xi) F[u, u_x](\xi, \tau + s_i) d\xi d\tau,$$

and hence

$$\begin{aligned} \lim_{t \downarrow s_i} u_t(x, t) &= \delta * u_{xx}[s_i] + \delta * F[u, u_x][s_i] + \\ &+ \lim_{t \downarrow s_i} \int_0^{t - s_i} \int_{-\infty}^{\infty} \frac{\partial G}{\partial t}(t - s_i - \tau, x - \xi) F[u, u_x](\xi, \tau + s_i) d\xi d\tau \\ &= u_{xx}(x, s_i) + F[u, u_x](x, s_i) = u_t(x, s_i), \end{aligned}$$

because the absolute value of the integral can be majorized by (3.30) with $\beta = 0$. Therefore, the above proven piecewise continuity of u_t in $U_i \mathbb{R} \times (s_i, s_{i+1})$ is actually continuity in $\mathbb{R} \times (0, T)$. \square

COROLLARY 3.6. *The conditions of Theorem 3.5 are satisfied if:*

- 1) $a = -\infty, b = \infty, \psi \in C^1(\mathbb{R}), F \in C^0(\mathbb{R} \times (0, T_1) \times \mathbb{R}^2)$, and $F \in C^1(\mathbb{R} \times (0, T_1] \times S)$ for any $0 < T_1 < T$ and S compact in \mathbb{R}^2 ;
- 2) $a > -\infty, b < \infty, \psi \in C^0([a, b]), \psi \in C^1((a, b)), \psi(a) = \psi(b) = 0$ if $u(a, t) = u(b, t) = 0, F \in C^0((a, b) \times (0, T) \times \mathbb{R}^2)$ and $F \in C^1((a, b) \times (0, T_1] \times S)$; if, moreover, $F \in C^2((a, b) \times (0, T_1) \times S)$ for any $0 < T_1 < T$ and S compact in \mathbb{R}^2 , then u_{xxx} and u_{xt} are continuous in $(a, b) \times (0, T)$;
- 3) if in both cases only $\psi \in C^0((a, b))$, then moreover $|F(x, t, u, p)| \leq K(1 + |p|^{2\beta})$ for $(x, t, u) \in (a, b) \times (0, T_1] \times (-N, N)$, and for some $\beta < 1$.

REMARK 3.7. The existence theorem for a classical solution, proven here, only requires that F is Hölder continuous, while for the uniqueness Lipschitz continuity with respect to u and p was sufficient.

For example, the equation

$$\begin{aligned} u_t - u_{xx} &= 2\sqrt{|u|}, & x \in \mathbb{R}, \quad t > 0, \\ u(x,0) &= 0, \end{aligned}$$

has the classical solutions $u(x,t) \equiv 0$ and

$$u(x,t) = \begin{cases} 0 & \text{for } t \leq c, \\ (t-c)^2 & \text{for } t \geq c, \end{cases}$$

for any $c \geq 0$. The function $2\sqrt{|u|}$ is Hölder, but not Lipschitz, continuous.

LITERATURE

- [1] AGMON, S., *Lectures on Elliptic Boundary Value Problems* (Van Nostrand, Princeton, N.J., 1965).
- [2] KOLMOGOROFF, A., I. PETROVSKY & N. PISCOUNOFF, *Étude de l'équation de la diffusion avec croissance de la quantité de matière et son application à un problème biologique*, Bull. Univ. Moscou, Ser. Internat., Sec. A, 1 (1937), #6, 1-25
- [3] LADYŽENSKAJA, O.A., V.A. SOLONNIKOV & N.N. URAL'CEVA, *Linear and Quasi-linear Equations of Parabolic Type*, Translations of Math. Mon., vol. 23 (Am. Math. Soc., Providence, R.I., 1968).
- [4] LIONS, J.L., *Equations Différentielles-operationelles et Problème aux Limites* (Springer, Berlin, 1961).
- [5] NEČAS, J., *Les méthodes directes en théorie des équations elliptiques*, Academia, Prague, 1967.
- [6] PROTTER, M.H. & H.F. WEINBERGER, *Maximum Principles in Differential Equations* (Prentice-Hall, Englewood Cliffs, N.J., 1967).
- [7] SCHWARTZ, L., *Théorie des Distributions*, Tome I (Hermann, Paris, 1951).
- [8] TEMME, N.M., ed., *Nonlinear Analysis*, Vol. II, MC Syllabus 26.2 (Mathematisch Centrum, Amsterdam, 1976).
- [9] WLOKA, J., *Grundräume und verallgemeinerte Funktionen*, Lecture Notes in Mathematics No. 82 (Springer, Berlin, 1969).
- [10] WLOKA, J., *Funktionalanalysis und Anwendungen* (De Gruyter, Berlin, 1971).

III. MONOTONE ITERATION

1. INTRODUCTION

In this chapter we will study monotone iteration schemes. As sources we used SATTINGER [1, Chapter 2; 2].

Monotone iteration schemes are interesting both for proving the existence of solutions of certain nonlinear elliptic and parabolic problems and for constructing the solutions explicitly. In Section 3 we give an iteration procedure for elliptic boundary value problems and we prove that the procedure indeed results in a solution of the problem. Thus, the existence of certain solutions of a boundary value problem is proved by a constructive method. Furthermore, we can give regions in which we can expect solutions. In Section 4 the results of Section 3 are applied to prove the existence of nontrivial solutions of a simple boundary value problem. The nonexistence of such solutions for certain values of a parameter is also proved. It is not possible to obtain all solutions by means of monotone iteration procedures as given in Section 3. In Section 5 it is shown that in this way only stable solutions of the corresponding parabolic initial value problem can be obtained. Thus the solutions found by iteration methods are asymptotically stable (at least from above or from below). Furthermore, it is sketched how solutions of a parabolic initial boundary value problem can be found by monotone iteration procedures.

The mathematical tools needed for the other sections are gathered in Section 2. A central role is played by the maximum principles for elliptic and parabolic problems. Further, we need some concepts from functional analysis in order to prove that the solutions we obtain are elements of the appropriate function spaces.

2. PRELIMINARIES

This section contains some mathematical concepts needed in the following sections. In this chapter all functions and coefficients are supposed to be real.

Let us consider the second order partial differential operator L

$$(2.1) \quad L = \sum_{i,j=1}^n a_{ij}(x) \frac{\partial^2}{\partial x_i \partial x_j} + \sum_{i=1}^n a_i(x) \frac{\partial}{\partial x_i},$$

where x denotes the vector (x_1, \dots, x_n) . This operator L is called *uniformly strongly elliptic* in a region $D \subset \mathbb{R}^n$ if the coefficients $a_{ij}(x)$ and $a_i(x)$, $i, j = 1, \dots, n$, are bounded on D and if a number $c_0 > 0$ exists such that

$$(2.2) \quad \sum_{i,j=1}^n a_{ij}(x) \xi_i \xi_j \geq c_0 \sum_{i=1}^n \xi_i^2,$$

for each $x \in D$, $\xi_i, \xi_j \in \mathbb{R}$.

In this chapter we assume that L is uniformly strongly elliptic and that D is a bounded region in \mathbb{R}^n . Let the Hölder space $C^{\ell+\alpha}(D)$ ($\ell=0,1,2,\dots$, $0<\alpha\leq 1$) be defined (cf. Section II.2.1) as the space of all functions f that are continuously differentiable in D up to order ℓ , such that the following norm is finite:

$$|f|_{\ell+\alpha} = \sup_{\substack{x \in D \\ |k| \leq \ell}} |D^k f(x)| + \sup_{\substack{x, y \in D \\ |k| = \ell}} \frac{|D^k f(x) - D^k f(y)|}{\|x-y\|^\alpha}.$$

In the special case $\ell = 0$, $\alpha = 1$ we call the function f Lipschitz continuous. Throughout this chapter it is permitted to take $\alpha = 1$. For the regularity of solutions of problems involving L we require that $a_{ij} \in C^{0+\alpha}(D)$ and $a_i \in C^{1+\alpha}(D)$, $0 < \alpha \leq 1$, $i, j = 1, 2, \dots, n$, and that the boundary of D is sufficiently smooth ($C^{2+\alpha}$).

2.1. Maximum principles

For the uniformly strongly elliptic operator L the following maximum principle holds.

THEOREM 2.1. *Let $u \in C^2(D) \cap C(\bar{D})$ satisfy the differential inequality*

$$Lu(x) + h(x)u(x) \geq 0$$

in a bounded domain $D \subset \mathbb{R}^n$, where h is a nonpositive function which is bounded on any compact subset of D . Furthermore, let $u \leq 0$ on the boundary of D . Then either $u < 0$ in D , or $u \equiv 0$ in D .

PROOF. First, we remark that Theorem II.2.1 holds if we replace the Laplace operator Δ by any uniformly strongly elliptic operator L (cf. PROTTER & WEINBERGER [3, Chapter 2, Theorem 6]). Theorem II.2.1 states that the maximum

of u is attained at the boundary of D , so $u \leq 0$; if $u = 0$ in an interior point of D , then $u \equiv 0$. \square

THEOREM 2.2. Let D be a bounded domain in \mathbb{R}^n and let $E = D \times (0, T]$. Suppose u is a solution of

$$Lu + f(x, u) - \frac{\partial u}{\partial t} = 0$$

in E , with boundary and initial conditions

$$\begin{aligned} u(x, t) &= g(x), & x \in D, & \quad 0 < t < T, \\ u(x, 0) &= u_0(x), & x \in D. \end{aligned}$$

Let z and Z satisfy the inequalities

$$\begin{cases} LZ + f(x, Z) - \frac{\partial Z}{\partial t} \leq 0, \\ Z(x, t)|_{\partial D} \geq g(x), \\ Z(x, 0) \geq u_0(x), \end{cases}$$

$$\begin{cases} LZ + f(x, z) - \frac{\partial z}{\partial t} \geq 0, \\ z(x, t)|_{\partial D} \leq g(x), \\ z(x, 0) \leq u_0(x); \end{cases}$$

and suppose that $f(x, y)$ is Lipschitz continuous with respect to y for $y \in [\inf_{(x, t) \in E} z(x, t), \sup_{(x, t) \in E} Z(x, t)]$, uniformly in x , then

$$z(x, t) \leq u(x, t) \leq Z(x, t)$$

in E .

PROOF. This theorem is a special case of Theorem 12 of PROTTER & WEINBERGER [3, p.187]. The proof of this theorem is similar to that of Theorem II.3.5 for the one-dimensional case. \square

2.2. Operators

We recall the following definitions and lemmas from TEMME [4, Chapter VI, Sections 2 and 4]. Let X and Y denote normed linear spaces. An operator $F: X \rightarrow Y$ is called *bounded* if it maps bounded sets of X into bounded sets of Y . An operator $F: X \rightarrow Y$ is called *continuous* if for any sequence $\{x_k\}$ in X

which converges to x , the sequence $\{Fx_k\}$ converges to Fx . A linear operator is continuous iff it is bounded. A (nonlinear) operator $F: X \rightarrow Y$ is called *compact* if it is continuous and has the property that $\{Fx_k\}$ has a convergent subsequence whenever $\{x_k\}$ is bounded.

LEMMA 2.3. *Let X, Y, Z denote normed vector spaces.*

- (i) *If $T: X \rightarrow Y$ is bounded and continuous and $S: Y \rightarrow Z$ is bounded and continuous, then $ST: X \rightarrow Z$ is bounded and continuous.*
- (ii) *If $T: X \rightarrow Y$ is bounded and continuous and $S: Y \rightarrow Z$ is compact, then $ST: X \rightarrow Z$ is compact.*

PROOF. Elementary. \square

LEMMA 2.4. *Let $0 < \alpha \leq 1$, $1 \leq p \leq \infty$, and let D be a bounded domain in \mathbb{R}^n with sufficiently smooth ($C^{2+\alpha}$) boundary. Then the identity maps*

$$I: C^{2+\alpha}(D) \rightarrow C^{0+\alpha}(D)$$

and

$$I: H^{2,p}(D) \rightarrow L^p(D)$$

are compact.

PROOF. These are special cases of Theorems II.2.1 and II.2.4. These theorems are not proved in Chapter II, but a proof can be found in WLOKA [5, Section 28] and WLOKA [6, Section 4].

LEMMA 2.5. *If $p > n$, then $H^{2,p}(D) \subset C^{0+\alpha}(D)$, $0 < \alpha \leq 1$, and the identity map is continuous.*

PROOF. By Theorem II.2.4, $H^{2,p}(D) \subset C^{1+\beta}(D)$, $\beta = 1 - \frac{n}{p}$. Theorem II.2.1 yields $C^{1+\beta}(D) \subset C^{0+\alpha}(D)$. The proofs of Theorems II.2.5 and II.2.1 can be found in MORREY [7, Theorem 3.6.6] and WLOKA [5, Section 28], respectively. \square

Another operator needed in the following sections is the nonlinear operator F acting on u such that $Fu(\cdot) = f(\cdot, u(\cdot))$.

LEMMA 2.6. *Given $f: \mathbb{R}^n \times \mathbb{R} \rightarrow \mathbb{R}$, let $f(\cdot, y): \mathbb{R}^n \rightarrow \mathbb{R}$ be Hölder continuous with exponent α uniformly in y , and let $f(x, \cdot): \mathbb{R} \rightarrow \mathbb{R}$ be Lipschitz continuous ($\alpha=1$) uniformly in x . Then $Fu(\cdot) = f(\cdot, u(\cdot))$ is Hölder continuous with exponent α for each $u \in C^{0+\alpha}$.*

LEMMA 2.7. *Let f satisfy the conditions of Lemma 2.6. Then the operator $F: C^{0+\alpha}(D) \rightarrow C^{0+\alpha}(D)$ is bounded and continuous.*

The proofs of these two lemmas are elementary.

LEMMA 2.8. *Let f satisfy the conditions of Lemma 2.6. Then $F: L^p(D) \rightarrow L^p(D)$ is bounded and continuous.*

PROOF. F maps all of $L^p(D)$ into $L^p(D)$ since D is bounded and F is Lipschitz continuous with respect to u . Therefore $F: L^p(D) \rightarrow L^p(D)$ is bounded and continuous, see e.g. TEMME [4, Chapter X, Theorem 2.4.2].

2.3. Existence and regularity of solutions

Consider the elliptic boundary value problem

$$(2.3) \quad \begin{cases} (L-\Omega)u = h(x) & \text{in } D, \\ u|_{\partial D} = g(x), \end{cases}$$

where L , given in (2.1), is uniformly strongly elliptic. The coefficients satisfy $a_{ij} \in C^{0+\alpha}(D)$, $a_i \in C^{1+\alpha}(D)$, $0 < \alpha \leq 1$. The domain D is bounded and the boundary is sufficiently smooth ($C^{2+\alpha}$). If $g(x)$ is a $C^{2+\alpha}$ function defined on the boundary of D , then $g(x)$ can be extended to a function $\hat{g}(x) \in C^{2+\alpha}(D)$. This is proved in TREVES [8, p.191]. If Ω is a nonpositive constant and $h \in C^{0+\alpha}(D)$, then we have the following theorem.

THEOREM 2.9 (SCHAUDER). *Under the above assumptions, the boundary value problem (2.3) has a unique solution $u \in C^{2+\alpha}(D)$, and furthermore,*

$$(2.4) \quad \|u\|_{2+\alpha} \leq K(\|h\|_{0+\alpha} + \|\hat{g}\|_{2+\alpha}),$$

where K does not depend on h and g .

PROOF. For the proof see COOLEN, FÖRCH, DE JAGER & PIJLS [9] or DOUGLIS & NIRENBERG [10].

For g fixed, the equation (2.3) has a unique solution $u \in C^{2+\alpha}(D)$ for each $h \in C^{0+\alpha}(D)$. We denote the map $h \mapsto u$ by G . Then $G: C^{0+\alpha}(D) \rightarrow C^{2+\alpha}(D)$ is the sum of a constant operator and a linear operator which is bounded by the estimates (2.4), thus G is continuous. We denote this operator by G because of its connection with the Green's function of (2.3); G is the inverse of the operator L with boundary conditions. Often we call G simply the inverse of L .

THEOREM 2.10. *Let $1 < p < \infty$ under the above assumptions for L , D and \hat{g} , the boundary value problem (2.3) has a unique solution $u \in H^{2,p}(D)$ if $h \in L^p(D)$ and, furthermore,*

$$(2.5) \quad \|u\|_{2,p} \leq K(\|h\|_{0,p} + \|\hat{g}\|_{2,p}).$$

PROOF. See AGMON, DOUGLIS & NIRENBERG [11, Theorem 15.2]. \square

For g fixed, the operator $G: L^p(D) \rightarrow H^{2,p}(D)$, associating with each admissible right-hand term h the uniquely determined solution u , is the sum of a constant operator and a bounded linear operator. Thus G is continuous.

The theorems on the existence and regularity of solutions of parabolic initial boundary value problems, as given in Chapter II, also hold when u_{xx} is replaced by Lu , where L is a uniformly strongly elliptic operator, with some additional requirements on the coefficients of L and on the region D . We need the existence of a regular solution of the following nonlinear problem:

$$(2.6) \quad \begin{cases} Lu + f(x,u) - \frac{\partial u}{\partial t} = 0, & x \in D, \quad 0 < t < T, \\ u(x,t) \Big|_{\partial D} = g(x), \\ u(x,0) = u_0(x), & x \in D, \end{cases}$$

where L and g are as given at the beginning of this subsection.

THEOREM 2.11. *Let L , g and D be as in Theorem 2.9, let $u_0 \in L^\infty(D)$.*

Moreover let $f(x,u)$ be Hölder continuous in $x \in D$, uniformly for all $u \in \mathbb{R}$ and Lipschitz continuous in $u \in \mathbb{R}$, uniformly for all $x \in D$. Then there exists a classical solution u of (2.6). Furthermore there exists a constant $\beta \in (0,1)$ such that for all D' with $\bar{D}' \subset D$ and for all bounded intervals I with $I \subset (0,\infty)$, this solution u satisfies $u(\cdot,t) \in C^{2+\beta}(D')$ for all $t \in I$, and $u(x,\cdot) \in C^{1+\beta}(I)$ for all $x \in D'$. Furthermore, if $u_0(x)$ is continuous, then

$$\lim_{t \rightarrow 0} u(x,t) = u_0(x).$$

PROOF. For the proof of this theorem we refer to LADYZHENSKAYA, SOLLONNIKOV & URAL'CEVA [12, p.419]. The techniques used there are similar to those used in the proof of Theorem II.3.5. \square

THEOREM 2.12. If $u(x,t)$ is a uniformly bounded solution of (2.6) and

$$\lim_{t \rightarrow \infty} u(x,t) = \hat{u}(x)$$

exists, then $\hat{u}(x)$ is a classical solution of the elliptic boundary value problem

$$(2.7) \quad \begin{cases} Lu + Fu = 0, \\ u|_{\partial D} = g, \end{cases}$$

where Fu is defined by $Fu(x) = f(x, u(x))$.

PROOF. We will give the proof for the homogeneous case $g = 0$. (There is no loss of generality, because we can always consider the difference between the function $u(x,t)$ and the solution of the elliptic boundary value problem $Lw = 0$ in D , $w|_{\partial D} = g$.)

First, we prove that $\hat{u}(x)$ is a weak solution of (2.7), i.e. $\hat{u} \in L^2(D)$, $L\hat{u} \in L^2(D)$, and

$$(2.8) \quad (L\hat{u}, \xi) + (F\hat{u}, \xi) = 0, \quad \forall \xi \in C_0^\infty(D),$$

where (\cdot, \cdot) is the L^2 inner product

$$(v, w) = \int_D vw \, dx.$$

Equation (2.8) is equivalent (cf. II.2) to

$$(\hat{u}, L^*\xi) + (F\hat{u}, \xi) = 0, \quad \forall \xi \in C_0^\infty(D),$$

where L^* is the adjoint operator of L :

$$L^*v = \sum_{i,j=1}^n \frac{\partial^2}{\partial x_i \partial x_j} (a_{ij}v) - \sum_{i=1}^n \frac{\partial}{\partial x_i} (a_i v).$$

The function $u(x,t)$ satisfies $Lu + Fu - \frac{\partial u}{\partial t} = 0$, $u|_{\partial D} = 0$. Taking the inner product with a function $\xi \in C_0^\infty(D)$, we obtain

$$(Lu, \xi) + (Fu, \xi) - (u_t, \xi) = 0.$$

Partial integration of the first term results in

$$(u, L^*\xi) + (Fu, \xi) - (u_t, \xi) = 0.$$

This equality holds for all t , $0 < t < \infty$. So we have

$$\frac{1}{T} \int_0^T (u, L^* \xi) dt + \frac{1}{T} \int_0^T (Fu, \xi) dt - \frac{1}{T} \int_0^T (u_t, \xi) dt = 0.$$

Now let $T \rightarrow \infty$; then

$$\frac{1}{T} \int_0^T (u, L^* \xi) dt \rightarrow (\hat{u}, L^* \xi),$$

because of the Lebesgue dominated convergence theorem. Here the assumption of uniform boundedness on the solution u is used. Similarly,

$$\frac{1}{T} \int_0^T (Fu, \xi) dt \rightarrow (F\hat{u}, \xi),$$

and

$$\frac{1}{T} \int_0^T (u_t, \xi) dt = \frac{1}{T} \int_0^T \frac{\partial}{\partial t} (u, \xi) dt = \frac{(u(\cdot, T), \xi) - (u(\cdot, 0), \xi)}{T} \rightarrow 0.$$

Therefore we get in the limit, as $T \rightarrow \infty$, that

$$(\hat{u}, L^* \xi) + (F\hat{u}, \xi) = 0,$$

for each $\xi \in C_0^\infty(D)$.

Now we have to show that \hat{u} is a regular solution of (2.7). First, we note that \hat{u} is uniformly bounded in D , and thus $\hat{u} \in L^p(D)$. Then, by the proof of Lemma 2.8, $F\hat{u} = f(\cdot, \hat{u}(\cdot)) \in L^p(D)$. Consider the boundary value problem

$$(2.9) \quad \begin{cases} Lw = -F\hat{u} & \text{in } D, \\ w|_{\partial D} = 0. \end{cases}$$

We recall that $F\hat{u}(x) = f(x, \hat{u}(x))$. Let G be the mapping that associates with each right-hand term the unique solution w . The solution of (2.9) may then be written as $w = -GF\hat{u} = -Gf(\cdot, \hat{u}(\cdot))$. Then $w \in H^{2,p}(D)$, by Theorem 2.10. If $p > n$, then $w \in C^{0+\alpha}(D)$, by Lemma 2.5. Thus we have

$$(w, L^* \xi) = -(GF\hat{u}, L^* \xi) = -(F\hat{u}, \xi) = (\hat{u}, L^* \xi),$$

hence

$$(w - \hat{u}, L^* \xi) = 0 \quad \text{for each } \xi \in C_0^\infty(D),$$

and thus $(w - \hat{u}, \eta) = 0$ for all $\eta \in C_0^\infty(D)$ because of the invertibility of L and thus of L^* . Thus $\hat{u} = w$ almost everywhere, and we can redefine \hat{u} on a set of measure zero such that $\hat{u} = w \in C^{0+\alpha}(D)$. Again putting

$$w = -GF\hat{u},$$

and using Theorem 2.9, we obtain that $w \in C^{2+\alpha}(D)$, and the same argument that $\hat{u} = w$ finally results in $\hat{u} \in C^{2+\alpha}(D)$, and thus \hat{u} is a regular solution of (2.7). \square

3. MONOTONE ITERATION SCHEMES WHICH CONVERGE TO SOLUTIONS OF A NONLINEAR ELLIPTIC BOUNDARY VALUE PROBLEM

Let us consider the nonlinear elliptic boundary value problem

$$(3.1) \quad \begin{cases} Lu + f(x, u) = 0 & \text{in } D, \\ u|_{\partial D} = g, \end{cases}$$

where L is a second order, uniformly strongly elliptic operator, as defined in Section 2 (formulas (2.1), (2.2)). Concerning L , f , g and D , the following assumptions are made: D is a bounded domain in \mathbb{R}^n and its boundary ∂D is sufficiently smooth ($C^{2+\alpha}$). The coefficients of L satisfy $a_{ij} \in C^{0+\alpha}(D)$, $a_i \in C^{1+\alpha}(D)$, and the function g on the boundary is the restriction of a function $\hat{g} \in C^{2+\alpha}(D)$. Finally, the function $f: \mathbb{R}^n \times \mathbb{R} \rightarrow \mathbb{R}$ is supposed to be of class $C^{0+\alpha}(D)$ with respect to x , uniformly in y , and continuously differentiable with respect to y , for all $x \in \bar{D}$.

We will use monotone iteration schemes to give a constructive proof of the existence of solutions of the boundary value problem (3.1). For this we need the notions of upper and lower solutions.

DEFINITION 3.1. An upper solution ϕ of (3.1) is a function such that

$$\begin{cases} \phi \in C^2(D) \cap C(\bar{D}), \\ L\phi(x) + f(x, \phi(x)) \leq 0, & x \in D, \\ \phi|_{\partial D} \geq g(x); \end{cases}$$

a lower solution ψ of (3.1) is a function such that

$$\begin{cases} \psi \in C^2(D) \cap C(\bar{D}), \\ L\psi(x) + f(x, \psi(x)) \geq 0, & x \in D, \\ \psi|_{\partial D} \leq g(x). \end{cases}$$

THEOREM 3.2. If there exists an upper solution ϕ and a lower solution ψ of

(3.1) such that

$$\psi \leq \phi \quad \text{in } D,$$

then a solution u of (3.1) exists such that

$$\psi \leq u \leq \phi \quad \text{in } D.$$

Before we prove this theorem we make some advance preparations. Given the functions ϕ and ψ we can consider the function f on the compact region

$$W = \{(x, y) \mid x \in \bar{D}, y \in [\inf_{x \in D} \psi, \sup_{x \in D} \phi]\}.$$

Then $f_y(x, y)$ is bounded on W and a nonnegative constant Ω exists such that

$$(3.2) \quad f_y(x, y) + \Omega > 0, \quad (x, y) \in W.$$

Consequently, $f(x, u) + \Omega u$ is monotone increasing in u for this choice of Ω .

Now let us consider the following boundary value problem

$$(3.3) \quad \begin{cases} (L-\Omega)u = -[f(x, v) + \Omega v] & \text{in } D, \\ u|_{\partial D} = g. \end{cases}$$

Let $u_1, u_2 \in C^2(D) \cap C(\bar{D})$ satisfy (3.3) with v replaced by v_1 , respectively v_2 . If $v_1 \leq v_2$, then $u_1 < u_2$ in D unless $v_1 \equiv v_2$. This is proved by the maximum principle (Theorem 2.1): the function $w = u_1 - u_2$ satisfies, by the monotonicity of $f(x, y) + \Omega y$:

$$\begin{cases} (L-\Omega)w = -[f(x, v_1) + \Omega v_1] + [f(x, v_2) + \Omega v_2] \geq 0, \\ w|_{\partial D} = 0. \end{cases}$$

The monotone operator $v \mapsto u$ in (3.3) will play a central role in the iteration scheme. Let us introduce some auxiliary operators. The nonlinear operator F is defined by

$$Fv(x) = -[f(x, v(x)) + \Omega v(x)].$$

Consider the linear boundary value problem

$$\begin{cases} (L-\Omega)w = h(x) & \text{in } D, \\ w|_{\partial D} = g; \end{cases}$$

then the linear operator G is the operator that associates with each right-hand term h the unique solution w . If v and h are elements of $C^{0+\alpha}(D)$, then by Lemma 2.7 $F: C^{0+\alpha}(D) \rightarrow C^{0+\alpha}(D)$ is a continuous and bounded operator, and by Theorem 2.9 $G: C^{0+\alpha}(D) \rightarrow C^{2+\alpha}(D)$ is a continuous operator since it is the sum of a bounded linear and a constant operator. So the composition $GF: C^{0+\alpha}(D) \rightarrow C^{2+\alpha}(D)$ is continuous and bounded. The identity map $I: C^{2+\alpha}(D) \rightarrow C^{0+\alpha}(D)$ is compact, and so the operator

$$(3.4) \quad T = IGF: C^{0+\alpha}(D) \rightarrow C^{0+\alpha}(D)$$

is compact (cf. Lemma 2.3). Furthermore, we have seen that T is monotone.

LEMMA 3.3. *Let ϕ and ψ be as in Definition 3.1. Then*

$$GF\phi < \phi \quad \text{in } D$$

and

$$GF\psi > \psi \quad \text{in } D,$$

unless $GF\phi = \phi$ or $GF\psi = \psi$.

PROOF. We give the proof for ϕ ; the proof for ψ is similar. The function ϕ is twice continuously differentiable in D , so it is certainly an element of $C^{0+\alpha}(D)$. Hence $GF\phi$ is a well-defined function in $C^{2+\alpha}(D)$. Consider $(GF\phi - \phi)$

$$\begin{aligned} (L-\Omega)(GF\phi - \phi) &= F\phi - (L-\Omega)\phi \geq 0 \quad \text{in } D, \\ (GF\phi - \phi)|_{\partial D} &= g - \phi|_{\partial D} \leq 0. \end{aligned}$$

Therefore by Theorem 2.1 $GF\phi - \phi < 0$ in D unless $GF\phi = \phi$. \square

PROOF OF THEOREM 3.2. We will now prove Theorem 3.2 by defining a monotone decreasing and a monotone increasing sequence of functions and by showing that they both tend to a solution of (3.1). Let T be given in (3.4), let $u_0 = \phi$, $v_0 = \psi$ and suppose u_k, v_k are given by $u_k = Tu_{k-1}$, $v_k = Tv_{k-1}$. Then by Lemma 3.3 and the monotonicity of T , the sequence $\{u_k\}$ is monotone decreasing and $\{v_k\}$ is monotone increasing. Furthermore, $\psi \leq \phi$ results in $v_k < u_k$, for all k . So both sequences are monotone and bounded and the pointwise limits $\hat{u} = \lim_{k \rightarrow \infty} u_k$ and $\hat{v} = \lim_{k \rightarrow \infty} v_k$ both exist. If we could prove the boundedness of $\{u_k\}$ and $\{v_k\}$ in $C^{0+\alpha}(D)$, then the compactness of T and the monotonicity of the sequences would be sufficient to show that $\hat{u} = \lim_{k \rightarrow \infty} u_k = \lim_{k \rightarrow \infty} Tu_{k-1} = T\hat{u}$, and similarly that $\hat{v} = T\hat{v}$, and \hat{u} and

$\hat{v} \in C^{0+\alpha}(D)$. Then the Schauder estimates (Theorem 2.9) would yield that \hat{u} and $\hat{v} \in C^{2+\alpha}(D)$, and so they would be regular solutions of (3.1). However, we are not able to prove the boundedness of both series in $C^{0+\alpha}(D)$ for a general elliptic operator, so we will follow another way, using Sobolev spaces. Now we consider $F: L^p(D) \rightarrow L^p(D)$, $G: L^p(D) \rightarrow H^{2,p}(D)$, and $H: H^{2,p}(D) \rightarrow L^p(D)$. Again, the operator

$$T = IGF: L^p(D) \rightarrow L^p(D)$$

is compact (cf. Lemmas 2.8, 2.3, 2.4 and Theorem 2.10). Because $\{u_k\}$ and $\{v_k\}$ are bounded by ψ and ϕ , the sequences $\{u_k\}$ and $\{v_k\}$ are bounded in $L^p(D)$. Thus, by the compactness of T , the sequences $\{Tu_k\}$ and $\{Tv_k\}$ have a convergent subsequence. Because of the monotonicity, $Tu_k \rightarrow \hat{u}$, $Tv_k \rightarrow \hat{v}$ in $L^p(D)$. Thus we have

$$\hat{u} = \lim_{k \rightarrow \infty} Tu_k = \lim_{k \rightarrow \infty} T^2 u_{k-1} = T\hat{u} \in L^p(D),$$

and similarly $\hat{v} = T\hat{v} \in L^p(D)$. So \hat{u} and \hat{v} are $L^p(D)$ functions satisfying $GF\hat{u} = \hat{u}$, $GF\hat{v} = \hat{v}$, and thus \hat{u} and $\hat{v} \in H^{2,p}(D)$. Then by Lemma 2.5, choosing $p > n$, we conclude that \hat{u} and $\hat{v} \in C^{0+\alpha}(D)$, and finally by the estimates of Schauder (Theorem 2.9) we conclude that \hat{u} and $\hat{v} \in C^{2+\alpha}(D)$ and thus are regular solutions of (3.1). From the monotonicity we have

$$\psi < v_k < \hat{v} \leq \hat{u} < u_k < \phi \quad \text{in } D. \quad \square$$

COROLLARY 3.4. *The solutions \hat{u} and \hat{v} constructed in the proof of Theorem 3.2 are maximal and minimal solutions in the region $\psi \leq u \leq \phi$: if w is a solution of (3.1) such that $\psi \leq w \leq \phi$, then $\hat{v} \leq w \leq \hat{u}$.*

PROOF. We have $w = Tw$, $w \leq \phi$ in D . By the monotonicity of T we have $Tw \leq T\phi$ in D , or $w \leq T\phi = u_1$ in D . By induction, we have $w \leq u_k$ in D for all k , and hence $w \leq \hat{u}$ in D . Similarly $w \geq \hat{v}$ in D . \square

4. AN EXAMPLE OF A BIFURCATION PROBLEM

In this section we will apply the results of the previous section to investigate the solutions of the boundary value problem

$$(4.1) \quad \begin{cases} (\Delta + \mu)u - u^3 = 0 & \text{in } D, \\ u = 0 & \text{on } \partial D, \end{cases}$$

where Δ is the Laplace operator,

$$\Delta = \sum_{i=1}^n \left(\frac{\partial}{\partial x_i} \right)^2,$$

in some domain $D \subset \mathbb{R}^n$ with smooth boundary ∂D . For the well-known results on linear eigenvalue problems used in this section we refer to COURANT & HILBERT [13, p.451, p.423].

4.1. Existence and nonexistence of nontrivial solutions

The linearized problem of (4.1) is

$$(4.2) \quad \begin{cases} (\Delta + \mu)v = 0 & \text{in } D, \\ v = 0 & \text{on } \partial D. \end{cases}$$

The boundary value problem (4.2) only has nontrivial solutions if $\mu = \lambda_1, \lambda_2, \dots$, where $0 < \lambda_1 \leq \lambda_2 \leq \dots$. Let ϕ_1 be the *first eigenfunction* of the Laplacian:

$$(4.3) \quad \begin{cases} \Delta \phi_1 + \lambda_1 \phi_1 = 0 & \text{in } D, \\ \phi_1 = 0 & \text{on } \partial D; \end{cases}$$

then $\lambda_1 > 0$ and $\phi_1 > 0$ in D and $\phi_1 \in C^{2+\alpha}(D)$ if ∂D is sufficiently smooth ($C^{2+\alpha}$).

First we will prove:

LEMMA 4.1. *If $\mu < \lambda_1$, then the boundary value problem (4.1) has no solutions other than $u \equiv 0$.*

PROOF. The eigenvalues of the Laplace operator depend monotonically and continuously on the domain (with mild qualifications on the variation of the domain). Specifically, if $\mu < \lambda_1$, there is a domain $D' \supset \bar{D}$ such that

$$\begin{cases} \Delta \psi_1 + \mu \psi_1 = 0 & \text{in } D', \\ \psi_1|_{\partial D'} = 0, \end{cases}$$

and $\psi_1 > 0$ in the interior of D' . Then ψ_1 is strictly positive on \bar{D} . If u is

a solution of (4.1) we consider the regular function

$$(4.4) \quad w = u/\psi_1.$$

Substitution of (4.4) into (4.1) results in the following equation for w :

$$\begin{cases} \Delta w + \frac{2}{\psi_1} (\nabla \psi_1) \cdot (\nabla w) + w(-w^2 \psi_1^2) = 0 & \text{in } D, \\ w|_{\partial D} = 0. \end{cases}$$

The coefficient of w is nonpositive, so by the maximum principle (Theorem 2.1) we have $w \equiv 0$ and therefore $u \equiv 0$ is the unique solution of (4.1) for $\mu < \lambda_1$. \square

THEOREM 4.2. *If $\mu > \lambda_1$, the boundary value problem (4.1) has at least two nontrivial solutions: one positive and one negative.*

PROOF. First note that if u is a solution, then $-u$ is also a solution. So we will only prove the existence of a positive solution. We will use the methods of the previous section, and so we will look for upper and lower solutions. To construct upper and lower solutions we consider the function $\sigma\phi_1$, where σ is a positive constant and ϕ_1 is the first eigenfunction of the Laplacian. Let ϕ_1 be normalized such that

$$(4.5) \quad \sup_{x \in D} |\phi_1(x)| = 1, \quad \phi_1 > 0 \text{ in } D.$$

Then we have

$$(4.6) \quad \begin{cases} (\Delta + \mu)(\sigma\phi_1) - (\sigma\phi_1)^3 = \sigma\phi_1[(\mu - \lambda_1) - \sigma^2\phi_1^2] & \text{in } D, \\ \sigma\phi_1 = 0 & \text{on } \partial D. \end{cases}$$

For $\mu > \lambda_1$, the right-hand side of (4.6) is nonnegative when σ is small enough, i.e. (cf. 4.5), when

$$(4.7) \quad 0 < \sigma \leq (\mu - \lambda_1)^{\frac{1}{2}}$$

we have

$$\begin{cases} (\Delta + \mu)(\sigma\phi_1) - (\sigma\phi_1)^3 \geq 0 & \text{in } D, \\ (\sigma\phi_1) = 0 & \text{on } \partial D, \end{cases}$$

and thus $\sigma\phi_1$ is a positive lower solution if σ satisfies (4.7). To get a positive upper solution $\geq \sigma\phi_1$ we consider $\beta\psi_1$, where ψ_1 is the first eigenfunction of

$$\begin{cases} \Delta\psi_1 + \lambda_1'\psi_1 = 0 & \text{in } D', \\ \psi_1 = 0 & \text{on } D' \supset \bar{D}, \end{cases}$$

so we have $\lambda_1' < \lambda_1 < \mu$ and $\beta\psi_1 > 0$ on \bar{D} if $\beta > 0$. The function $\beta\psi_1$ satisfies the equation

$$\begin{cases} (\Delta + \mu)(\beta\psi_1) - (\beta\psi_1)^3 = \beta\psi_1[(\mu - \lambda_1') - \beta^2\psi_1^2] & \text{in } D, \\ \beta\psi_1 > 0 & \text{on } \partial D. \end{cases}$$

Since $\beta\psi_1 > 0$ on \bar{D} , the quantity in brackets is negative for suitably large β . Therefore, $\beta\psi_1$ is an upper solution for large positive β (see Figure 1), and for β large enough we have, in addition, $\beta\psi_1 > \sigma\phi_1 > 0$. So we have found a positive lower solution,

$$\psi = \sigma\phi_1, \quad 0 < \sigma < (\mu - \lambda_1)^{\frac{1}{2}},$$

and a positive upper solution,

$$\phi = \beta\psi_1, \quad \beta > 0,$$

of (4.1). Also, the inequality

$$\psi \leq \phi \quad \text{in } D$$

Figure 1

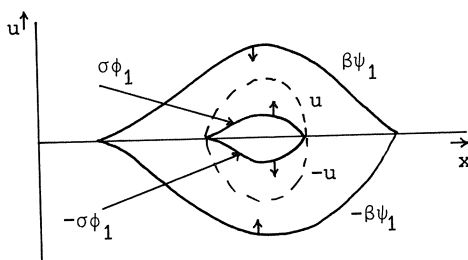

holds. By Theorem 3.2, the existence of a positive solution $\psi \leq u \leq \phi$ is proved for $\mu > \lambda_1$, and similarly a negative solution $-u$, $-\phi \leq -u \leq -\psi$ exists. \square

REMARK 4.3. From the proof of Theorem 4.2 it follows that the positive solution u exceeds $\sigma\phi_1$, where $\sup_{x \in D} |\phi_1(x)| = 1$ and σ can be chosen to be $(\mu - \lambda_1)^{\frac{1}{2}}$. This shows that the positive solution has a maximum value exceeding $(\mu - \lambda_1)^{\frac{1}{2}}$ and tending to $+\infty$ as $\mu \rightarrow +\infty$.

4.2. Stability of the trivial solution for $\mu < \lambda_1$

We wish to examine the stability of the solutions found by the iteration method. In the following section we will prove that if there is only one solution $\psi \leq u \leq \phi$, where ψ is a lower solution and ϕ is an upper solution, then this solution is asymptotically stable. In this subsection we will give an upper and a lower solution for the null solution of (4.1) if $\mu < \lambda_1$, and in Theorem 4.5 we will prove that this solution is indeed asymptotically stable.

LEMMA 4.4. *If $\mu < \lambda_1$, then ϕ_1 (defined in 4.3) is an upper solution and $-\phi_1$ is a lower solution for (4.1).*

PROOF. The function ϕ_1 satisfies

$$\begin{cases} (\Delta + \mu)\phi_1 - \phi_1^3 = [\mu - \lambda_1 - \phi_1^2]\phi_1 < 0 & \text{in } D, \\ \phi_1|_{\partial D} = 0, \end{cases}$$

because $\mu < \lambda_1$ and $\phi_1 > 0$. Similarly

$$\begin{cases} (\Delta + \mu)(-\phi_1) - (-\phi_1)^3 > 0 & \text{in } D, \\ -\phi_1|_{\partial D} = 0. \quad \square \end{cases}$$

We will prove that for $\mu < \lambda_1$ the solution $u = 0$ is a stable solution of the parabolic initial value problem

$$(4.8) \quad \begin{cases} (\Delta + \mu)u - u^3 - \frac{\partial u}{\partial t} = 0, \\ u = 0 \quad x \in \partial D, \\ u(x, 0) = u_0(x), \end{cases}$$

corresponding to the boundary value problem (4.1).

THEOREM 4.5. When $\mu < \lambda_1$, there exist constants $k > 0$ and $\sigma > 0$ (depending only on $\lambda_1 - \mu$) such that the solution u of the initial value problem (4.8) satisfies

$$(4.9) \quad |u(x,t)| \leq k e^{-\sigma t} \sup_{x \in D} |u_0(x)|.$$

PROOF. Let $\psi_1(x)$ be the first eigenfunction of the Laplacian on a region $D' \supset \bar{D}$ such that the first eigenvalue λ_1' satisfies $\mu < \lambda_1' < \lambda$. Thus we have

$$\begin{cases} \Delta \psi_1(x) + \lambda_1' \psi_1(x) = 0 & \text{in } D' \supset \bar{D}, \\ \psi_1(x) = 0 & \text{on } \partial D', \end{cases}$$

and $\psi_1(x) > 0$ in \bar{D} . Normalize $\psi_1(x)$ so that $\sup_{x \in \bar{D}} |\psi_1(x)| = 1$, and put

$$u(x,t) = w(x,t) \psi_1(x) e^{-\sigma t},$$

with $\sigma > 0$ to be chosen later. We get for w the equation

$$\Delta w + 2 \frac{\nabla \psi_1}{\psi_1} \cdot \nabla w + w[(\mu - \lambda_1') - w^2 \psi_1^{2+\sigma}] - \frac{\partial w}{\partial t} = 0,$$

$$w|_{\partial D} = 0,$$

$$w(x,0) = \frac{u_0(x)}{\psi_1(x)}.$$

If σ is chosen so that $\mu - \lambda_1' + \sigma \leq 0$, then the quantity in brackets is always negative, so by the maximum principle (Theorem 2.2) we have

$$|w(x,t)| \leq \sup_{x \in D} |w(x,0)| = \sup_{x \in D} \left| \frac{u_0(x)}{\psi_1(x)} \right|.$$

The theorem now follows by taking

$$k = \sup_{x \in D} \frac{1}{|\psi_1(x)|}. \quad \square$$

5. THE STABILITY OF SOLUTIONS OBTAINED BY ITERATION

In this section we consider the stability properties of the solutions of the elliptic boundary value problem obtained by the monotone iteration process of Section 3. Let us consider the parabolic boundary initial value problem

$$(5.1) \quad \begin{cases} Lu(x,t) + f(x,u(x,t)) - \frac{\partial(u(x,t))}{\partial t} = 0, \\ u(x,t) \Big|_{\partial D} = g(x), \\ u(x,0) = u_0(x), \end{cases}$$

with the same assumptions on D, L, f and g as in Section 3. Then the solutions of (3.1) are time-independent solutions of (5.1). In this section we will show that the solution \hat{u} obtained by starting the iteration at ϕ , an upper solution of (3.1), is asymptotically stable from above:

$$\text{if } \hat{u}(x) \leq u_0(x) \leq \phi(x), \text{ then } \lim_{t \rightarrow \infty} u(x,t) = \hat{u}(x);$$

and similarly, the solution \hat{v} is stable from below. In the special case that $\hat{u} = \hat{v}$ we will have that \hat{u} is asymptotically stable: if $\psi(x) \leq u_0(x) \leq \phi(x)$, $x \in D$, then $u(x,t) \rightarrow \hat{u}(x)$ if $t \rightarrow \infty$. So, with the iteration methods given in Section 3 it is not possible to obtain unstable solutions. On the other hand, each solution obtained by iteration is asymptotically stable at least from above or from below.

THEOREM 5.1. *If ϕ is an upper solution of (3.1), then the solution $Z(x,t)$ of the parabolic initial value problem (5.1) with initial data $Z(x,0) = \phi(x)$ is a monotonically nonincreasing function of t . If ψ is a lower solution of (3.1), then the solution $z(x,t)$ of (5.1) with initial data $z(x,0) = \psi(x)$ is nondecreasing in t .*

PROOF. If Z exists then it satisfies

$$\begin{cases} LZ + f(x,Z) - \frac{\partial Z}{\partial t} = 0, \\ Z(x,t) \Big|_{\partial D} = g(x), \\ Z(x,0) = \phi(x), \end{cases}$$

and $\phi(x)$ satisfies

$$\begin{cases} L\phi + f(x, \phi) - \frac{\partial \phi}{\partial t} \leq 0, \\ \phi(x) \Big|_{\partial D} \geq g(x), \\ \phi(x) = \phi(x), \quad t = 0 \end{cases}$$

(ϕ is independent of t , thus $\frac{\partial \phi}{\partial t} = 0$). Thus by Theorem 2.2 we have $Z(x, t) \leq \phi(x)$. Now let us consider the function $Z_h(x, t) = Z(x, t+h)$, $h > 0$. The function $Z_h(x, t)$ satisfies (5.1) with initial data

$$Z_h(x, 0) = Z(x, h) \leq \phi(x).$$

Thus by Theorem 2.2 $Z_h(x, t) \leq Z(x, t)$ and so $Z(x, t)$ is nonincreasing in t . The proof that $z(x, t)$ is nondecreasing is similar. So we have

$$\psi(x) \leq z(x, t) \leq Z(x, t) \leq \phi(x).$$

The function $f(x, y)$ is supposed to be continuously differentiable in y so it is Lipschitz continuous on any compact subset S of \mathbb{R} . We know that if z and Z exist then z and $Z \in \bar{S} = [\inf_{x \in D} \psi(x), \sup_{x \in D} \phi(x)]$, so if $f(x, y)$ is not uniformly Lipschitz continuous on \mathbb{R} then we can change $f(x, y)$ for $y \notin \bar{S}$ such that $f(x, y)$ does have the required property. Now existence and regularity is guaranteed by Theorem 2.11. \square

By Theorem 2.2 each solution $u(x, t)$ of (5.1) with $\psi(x) \leq u_0(x) \leq \phi(x)$ satisfies

$$\psi(x) \leq z(x, t) \leq u(x, t) \leq Z(x, t) \leq \phi(x).$$

In particular $Z(x, t)$ satisfies $\hat{u}(x) \leq Z(x, t) \leq \phi(x)$. So $Z(x, t)$ is bounded below and is monotonically decreasing in t ; thus $\lim_{t \rightarrow \infty} Z(x, t)$ exists and is a solution of the elliptic boundary value problem (3.1), by Theorem 2.12. Because of the maximality of $\hat{u}(x)$ (cf. Corollary 3.4) we have

$$\lim_{t \rightarrow \infty} Z(x, t) = \hat{u}(x).$$

Each solution $u(x, t)$ with initial data $\hat{u}(x) \leq u_0(x) \leq \phi(x)$ satisfies

$$\hat{u}(\mathbf{x}) \leq u(\mathbf{x}, t) \leq Z(\mathbf{x}, t),$$

and so we have proved:

LEMMA 5.2. *If $u(\mathbf{x}, t)$ is a solution of (5.1) with initial data $\hat{u}(\mathbf{x}) \leq u_0(\mathbf{x}) \leq \phi(\mathbf{x})$, then*

$$\lim_{t \rightarrow \infty} u(\mathbf{x}, t) = \hat{u}(\mathbf{x}).$$

If $\psi(\mathbf{x}) \leq u_0(\mathbf{x}) \leq \hat{v}(\mathbf{x})$, then

$$\lim_{t \rightarrow \infty} u(\mathbf{x}, t) = \hat{v}(\mathbf{x}).$$

If $\hat{u} = \hat{v}$, then \hat{u} is asymptotically stable both from above and from below.

COROLLARY 5.3. *If there exist an upper solution ϕ and a lower solution ψ of (3.1), and if there is only one solution \hat{u} such that $\psi(\mathbf{x}) \leq \hat{u}(\mathbf{x}) \leq \phi(\mathbf{x})$, then this solution is an asymptotically stable equilibrium solution of the parabolic boundary initial value problem (5.1) and each solution of (5.1) with initial data $\psi(\mathbf{x}) \leq u_0(\mathbf{x}) \leq \phi(\mathbf{x})$ tends to $\hat{u}(\mathbf{x})$ if $t \rightarrow \infty$.*

A converse to Corollary 5.3 also holds: Let us consider the derivative operator $L + f_u(\mathbf{x}, \hat{u}(\mathbf{x}))$. Then the first eigenfunction ϕ_1 of the eigenvalue problem

$$\begin{cases} L\phi + f_u(\mathbf{x}, \hat{u}(\mathbf{x}))\phi = \lambda\phi, \\ \phi|_{\partial D} = 0, \end{cases}$$

is positive. Let λ_1 be the associated eigenvalue.

THEOREM 5.4. *If $\lambda_1 < 0$, then \hat{u} is stable and is the limit of upper solutions from above and lower solutions from below. If $\lambda_1 > 0$, and \hat{u} is an isolated solution then \hat{u} is unstable.*

PROOF. Suppose $\lambda_1 < 0$ and consider $v = \hat{u} + \varepsilon\phi_1$. We have

$$f(\mathbf{x}, \hat{u} + \varepsilon\phi_1) = f(\mathbf{x}, \hat{u}) + \varepsilon\phi_1 f_u(\mathbf{x}, \hat{u}) + o(\varepsilon\phi_1)$$

($f(\mathbf{x}, \cdot)$ is supposed to be continuously differentiable), and thus

$$\begin{cases} Lv + f(x, v) = \varepsilon \lambda_1 \phi_1 + \phi_1 o(\varepsilon), \\ v|_{\partial D} = g. \end{cases}$$

Since $\phi_1 \geq 0$ and $\varepsilon \lambda_1 \phi_1$ dominates the term $\phi_1 o(\varepsilon)$ for small ε , v is an upper solution for $\varepsilon > 0$ and a lower solution for $\varepsilon < 0$. Now the stability of \hat{u} follows from Corollary 5.3. This establishes the first statement of the theorem. If $\lambda_1 > 0$, then $\hat{u} + \varepsilon \phi_1$ is a lower solution for $\varepsilon > 0$ and an upper solution for $\varepsilon < 0$. To establish the instability of \hat{u} , let v_δ be a solution of the initial value problem (5.1) with $v_\delta(x, 0) = \hat{u} + \delta \phi_1$ (say $\delta > 0$). Then $v_\delta(x, t)$ is increasing for $t > 0$ (assuming δ is sufficiently small so that $v_\delta(x, 0)$ is a lower solution). Consequently, either $v_\delta(x, t)$ tends to infinity or it tends to an equilibrium solution \hat{v}_δ with

$$\hat{v}_\delta(x) \geq v_\delta(x, 0) > \hat{u}(x) \quad \text{in } D,$$

and thus \hat{u} is an unstable solution. Here we need that the solution \hat{u} is isolated, because otherwise it would be possible that $\hat{v}_\delta \rightarrow \hat{u}$ as $\delta \rightarrow 0$. In the one dimensional case it will be proved that it is not necessary to require that \hat{u} is isolated (cf. Chapter V, Theorem 7.3). \square

Finally we make the following remark:

REMARK 5.5. The boundary condition $u|_{\partial D} = g$ can be replaced by the general boundary condition

$$\frac{\partial u}{\partial \nu} + bu|_{\partial D} = g,$$

where $b \geq 0$, $b \not\equiv 0$, and ν is an outward directed vector field, and b and ν are sufficiently smooth.

REMARK 5.6. By the methods of this chapter the existence of a nontrivial solution u , $0 < u < 1$, of the problem treated in Chapter I (I.(5.3), I.(5.4)) can be proved when both the solution $u = 0$ and the solution $u = 1$ are unstable.

For the application of the iteration scheme of Section 3 of this chapter, we make the substitution $\underline{u} = e^{-x^2} u$ in (5.4) of Chapter I, in order to get boundary conditions which guarantee uniqueness in (3.3) of this chapter.

REMARK 5.7. It is possible to obtain the solution of the initial boundary value problem (5.1) by using the iteration scheme

$$\begin{aligned} (L-\Omega)u_n - \frac{\partial u_n}{\partial t} &= -[f(x, u_{n-1}(x)) + \Omega u_{n-1}(x)], \\ u_n(x, t) \Big|_{\partial D} &= g(x), \\ u_n(x, 0) &= u_0(x), \end{aligned}$$

starting at an upper or a lower solution.

LITERATURE

- [1] SATTINGER, D.H., *Topics in Stability and Bifurcation Theory*, Lecture Notes in Math. No. 309 (Springer, Berlin, 1973).
- [2] SATTINGER, D.H., *Monotone methods in nonlinear elliptic and parabolic boundary value problems*, Indiana Univ. Math. J. 21 (1972) 979-1000.
- [3] PROTTER, M.H. & H.F. WEINBERGER, *Maximum Principles in Differential Equations* (Prentice-Hall, Englewood Cliffs, N.J., 1967).
- [4] TEMME, N.M., ed., *Nonlinear Analysis*, Vol. II, MC Syllabus 26.2 (mathematisch Centrum, Amsterdam, 1976).
- [5] WLOKA, J., *Funktionalanalysis und Anwendungen* (De Gruyter, Berlin, 1971).
- [6] WLOKA, J., *Grundräume und Verallgemeinerte Funktionen*, Lecture Notes in Math. No. 82 (Springer, Berlin, 1969).
- [7] MORREY Jr., C.B., *Multiple Integrals in the Calculus of Variations* (Springer, Berlin, 1966).
- [8] TREVES, F., *Basic Linear Partial Differential Equations* (Academic Press, New York, 1975).
- [9] COOLEN, T.M.T., G.J.R. FÖRCH, E.M. DE JAGER & H.G.J. PIJLS, *Colloquium Elliptische Differentiaalvergelijkingen*, Deel I, MC Syllabus 9.1 (Mathematisch Centrum, Amsterdam, 1969), (in Dutch).
- [10] DOUGLIS, A. & L. NIRENBERG, *Interior estimates for elliptic systems of partial differential equations*, Comm. Pure Appl. Math. 8 (1955) 503-538.

- [11] AGMON, S., A. DOUGLIS & L. NIRENBERG, *Estimates near the boundary for solutions of elliptic partial differential equations satisfying general boundary conditions, I*, Comm. Pure Appl. Math. 12 (1959) 623-727.
- [12] LADYZHENSKAYA, O.A., V.A. SOLONNIKOV & N.N. URAL'CEVA, *Linear and Quasilinear Equations of Parabolic Type*, Translations of Mathematical Monographs, Vol. 23 (Am. Math. Soc., Providence, R.I., 1968).
- [13] COURANT, R. & D. HILBERT, *Methods of Mathematical Physics*, Vol. 1 (Interscience, New York, 1953).

IV. TRAVELLING FRONTS

1. INTRODUCTION

Mathematical models of biological phenomena are one of the most important sources of nonlinear diffusion problems. Perhaps the earliest indication of this is to be found in the work of FISHER [1,2] on a population genetic model. For continuous time and spatially distributed populations the model leads to the nonlinear diffusion equation

$$(1.1) \quad u_t = \Delta u + f(u),$$

where

$$(1.2) \quad f(u) = u(1-u)\{(\tau_1 - \tau_2)(1-u) - (\tau_3 - \tau_2)u\}$$

and u denotes the relative density of a certain gene in the population (see Section I.4).

The relevant questions to be asked about the solutions of (1.1) depend on some further information concerning the domain of definition and the boundary conditions, if any. In the Sections 2,3 and 4 of the present chapter we will study equation (1.1) when the space domain is one-dimensional and unbounded at both sides. Consequently there are no boundary conditions. Since u is supposed to be a frequency, we occupy ourselves with solutions u satisfying $0 \leq u \leq 1$ only. In Sections 2 and 3 we assume that f satisfies some qualitative properties, namely

$$(1.3) \quad f \in C^1[0,1], \quad f(0) = f(1) = 0, \quad f(u) > 0 \text{ in } (0,1), \\ f'(0) > 0, \quad f'(1) < 0.$$

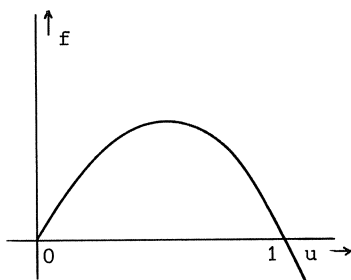

Figure 1

In the event that f is given by (1.2), this corresponds to $\tau_3 < \tau_2 < \tau_1$. In Section 4 the more complicated situation which arises when f changes sign on $[0,1]$ will be analysed. Finally, Section 5 is devoted to the initial-boundary value problem for equation (1.1) when the space domain is at one side bounded.

For theorems on existence and uniqueness of solutions of the initial value problem we refer to Chapter II. Under these presuppositions, what are the really interesting questions?

First of all, one wants to know whether or not $u \equiv 0$ and $u \equiv 1$ are the only equilibrium solutions (i.e., solutions of $u_{xx} + f(u) = 0$) satisfying $0 \leq u \leq 1$. Of course, the autonomous ordinary differential equation $u_{xx} + f(u) = 0$ can be studied very well by analyzing trajectories in the phase plane.

Then, one is interested in the stability of equilibrium solutions and in their domain of attraction (which is defined as the set of initial functions for which the solution approaches the equilibrium solution as $t \rightarrow \infty$). The appropriate techniques for solving this question are Lyapunov's second method, and the method of constructing upper or lower solutions and using the maximum principle. Related to this are the question of stabilization (does every solution tend to some equilibrium solution as $t \rightarrow \infty$?), and the question of (non)existence of periodic solutions.

The next step may be to ask about the approach towards equilibrium solutions, and here one encounters an intriguing phenomenon which is typical for an unbounded space domain. For ease of formulation we first state a definition.

DEFINITION 1.1. A solution $u(x,t) = w(x-ct)$ of

$$(1.4) \quad u_t = u_{xx} + f(u),$$

where $w(-\infty) = 1$, $w(+\infty) = 0$ and $0 \leq w \leq 1$, is called a (*travelling*) *front* and the constant c is called the *speed* of the front.

One may visualize a travelling front as a function of x which, as time increases, is propagated with constant velocity c without any alteration in shape.

Travelling fronts have already been mentioned by FISHER [1, 2], and he

conjectured the existence of a minimal speed. In 1937 KOLMOGOROFF et al. [3] actually proved the existence of a closed half-line $[c_0, \infty)$ of possible speeds.

By definition, a front is a solution of

$$(1.5) \quad w'' + cw' + f(w) = 0,$$

satisfying $w(-\infty) = 1$, $w(+\infty) = 0$, $0 \leq w \leq 1$. The autonomous ordinary differential equation (1.5) can be studied by phase plane methods. The objective is then to show the existence of a trajectory connecting the singular points $(w, w') = (1, 0)$ and $(w, w') = (0, 0)$ (a so-called heteroclinic trajectory). Clearly this amounts to studying the invariant manifolds that are associated with the singular points, and in particular their dependence on the parameter c . This will be done in Section 2 and the results will then be used in Section 3 to obtain information on the asymptotic behaviour as $t \rightarrow \infty$ of solutions of the initial value problem. In Section 4 we follow the same lines with now f satisfying different qualitative assumptions and in Section 5 analogous results for the initial-boundary value problem are derived.

Though in this chapter we will hardly enter into the question of stability of travelling fronts, some remarks seem to be in order. Let w be a travelling front; then the set

$$\{w(x-ct) \mid -\infty < t < \infty\}$$

is clearly invariant with respect to the differential equation (1.4), and one can associate a notion of stability with the travelling front w . One cannot expect that $|w(x-ct) - u(x, t)| \rightarrow 0$ as $t \rightarrow \infty$ if $|w(x) - u(x, 0)|$ is small, as is clear from taking $u(x, 0) = w(x+h)$, with h small. Rather, one would expect that at best $|w(x-ct+h) - u(x, t)| \rightarrow 0$ as $t \rightarrow \infty$ for some suitably chosen h , and perhaps the best formulation is the following: If

$\sup_{-\infty < x < \infty} |w(x) - u(x, 0)|$ is small, is

$$\lim_{t \rightarrow \infty} \inf_{-\infty < h < \infty} \sup_{-\infty < x < \infty} |w(x-ct+h) - u(x, t)| = 0?$$

One should compare this notion of (asymptotic) stability with the no-

tion of orbital stability of periodic solutions. The question of stability of travelling fronts, and in particular the characterization of domains of attraction, is only beginning to be analyzed and the interested reader may consult [4, 5]. Some recent results of FIFE & McLEOD [6,16] are treated in Section 4.

Thus far, we have motivated the study of equation (1.4) with the application in population genetics only. However, one should realize that quite different phenomena may have completely similar dynamic behaviour and can be modelled by the same equation (though the underlying mechanism is, of course, in no sense the same). Regarding equation (1.4) we mention flame propagation ([7]) and chemical reactions. Moreover, the study of equation (1.4) may be viewed as a first step towards the analysis of the more complicated equations describing nerve impulse propagation (see Chapter VII).

Finally, we mention that the material in the next sections is to a great extent based on papers of HADELER & ROTHE [8], ARONSON & WEINBERGER [9] and FIFE & McLEOD [6,16].

2. PHASE PLANE CONSIDERATIONS

In this section we will study the autonomous ordinary differential equation

$$(2.1) \quad u_{xx} + cu_x + f(u) = 0,$$

with f satisfying (1.3), by analyzing the trajectories of the corresponding system of first order equations

$$(2.2) \quad \begin{aligned} u_x &= v, \\ v_x &= -f(u) - cv \end{aligned}$$

in the (u,v) -plane (the so-called phase plane). In the first subsection we discuss the types of singular points (i.e., solutions of $v = 0$, $f(u) = 0$). In the second subsection we occupy ourselves with trajectories joining singular points, and we subsequently treat the characterization of the set of values of c for which such trajectories exist. Finally the example with $f(u) = u(1-u)(1+vu)$, $v > -1$ is worked out in some detail.

2.1. Types of singular points

Let us introduce the vector notation $\xi = (u, v)^T$, $F(\xi, c) = (v, -f(u) - cv)^T$, then (2.2) can be written as

$$(2.3) \quad \frac{d\xi}{dx} = F(\xi, c),$$

where we have emphasized the dependence of the system on the parameter c . Under very mild restrictions with regard to F (as we have $f \in C^1$, these requirements are satisfied) one can prove that solutions of the nonlinear system show in general near a singular point the same qualitative behaviour as solutions of the linearized system (cf. CODDINGTON & LEVINSON [10, Ch.15]; see below for the exceptions). It follows that the behaviour near a singular point $\xi = \xi_0$ can be determined to some extent from the knowledge of the eigenvalues of the Jacobian matrix $F'(\xi_0, c)$, the derivative of $F(\cdot, c)$ with respect to ξ at ξ_0 .

In our particular case the singular points are the points $\xi_0 = (u_0, 0)$ with $f(u_0) = 0$. Moreover

$$F'(\xi_0, c) = \begin{pmatrix} 0 & 1 \\ -f'(u_0) & -c \end{pmatrix},$$

and the eigenvalues are

$$\lambda_1 = \{-c + \sqrt{c^2 - 4f'(u_0)}\}/2, \quad \lambda_2 = \{-c - \sqrt{c^2 - 4f'(u_0)}\}/2.$$

Note that the eigenvalues are either real or complex conjugated. We distinguish the following cases.

Case a. Both eigenvalues λ_1, λ_2 are real and have opposite sign, say $\lambda_1 > 0$, $\lambda_2 < 0$. Then the singular point is called a *saddle point*. The solutions of the linearized equation are given by

$$\xi(x) = \xi_0 + c_1 \xi_1 e^{\lambda_1 x} + c_2 \xi_2 e^{\lambda_2 x},$$

with c_1, c_2 arbitrary constants and ξ_1, ξ_2 the eigenvectors belonging to λ_1, λ_2 respectively. For $c_1 = 0, c_2 \neq 0$ the solution tends to ξ_0 for $x \rightarrow +\infty$, whereas if $c_1 \neq 0, c_2 = 0$ the solution tends to ξ_0 for $x \rightarrow -\infty$; and if both $c_1 \neq 0, c_2 \neq 0$, then the solution does not tend to ξ_0 for either $x \rightarrow +\infty$ or

$x \rightarrow -\infty$. The two eigenvectors thus define two one-dimensional linear manifolds: $C_i = \{\alpha \xi_i \mid \alpha \in \mathbb{R}\}$, $i = 1, 2$. C_1 is called the *unstable*, C_2 the *stable* manifold.

For the nonlinear system there exist two manifolds, S_1, S_2 which are invariant with respect to the differential equation, and which have the same properties as mentioned for C_1 and C_2 . S_i will be tangent to C_i at the singular point. C_i, S_i are also called *separatrices* (see Fig.2).

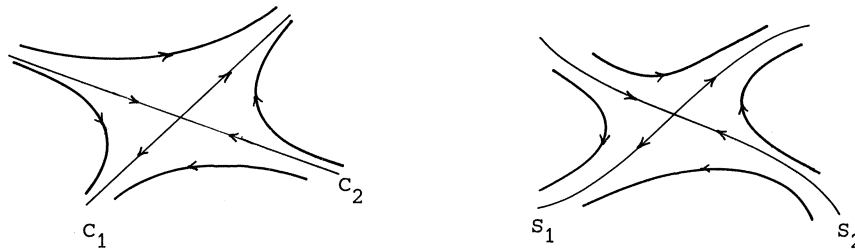

Figure 2

With our special matrix $F'(\xi_0, c)$, we have a saddle point if $f'(u_0) < 0$.

Case b. Both eigenvalues λ_1, λ_2 are real and have the same sign. Then the singular point is called a *node*, and $\lambda_1 > 0$ refers to an unstable, $\lambda_1 < 0$ to a stable node. We can distinguish further.

- b.1. $\lambda_1 \neq \lambda_2$: *two-tangent node*. All but two trajectories depart from or arrive at the singular point in the so-called *main direction*, while the remaining trajectories will do so in the so-called *side direction* (see Fig.3). For the nonlinear system we get main and side manifolds, tangent to the main and side direction at the singular point. In our case this type will appear if $c^2 > 4f'(u_0) > 0$.
- b.2. $\lambda_1 = \lambda_2$, Riesz-index = 1 (see TEMME [11, p.79]): *star-like node*. All the trajectories depart from or arrive at the equilibrium point with their own direction (see Fig.4). Due to the special form of our matrix $F'(\xi_0, c)$ we shall not encounter this case.

- b.3. $\lambda_1 = \lambda_2$, Riesz-index = 2: *one-tangent node*. All the trajectories depart from or arrive at the singular point in one direction only (see Fig.5). This will happen in our case if $c \neq 0$ and $c^2 = 4f'(u_0)$.

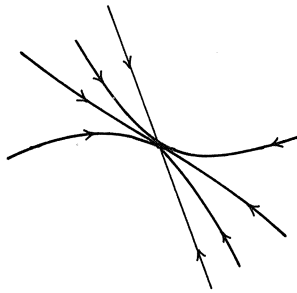

Figure 3

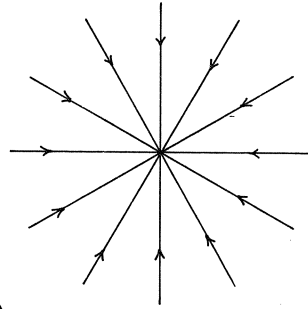

Figure 4

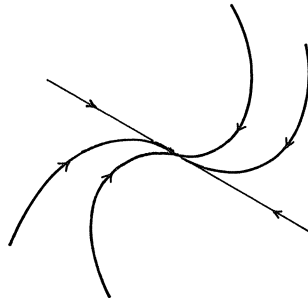

Figure 5

Case c. The eigenvalues $\lambda_1, \lambda_2 = \bar{\lambda}_1$ are complex conjugates, $\text{Re } \lambda_1 \neq 0$. Then the singular point is called a *focus* or *spiral*. The solutions will circle around this point. For $\text{Re } \lambda_1 > 0$ (resp. $\text{Re } \lambda_1 < 0$) they will tend to the singular point for $x \rightarrow -\infty$ (resp. $x \rightarrow +\infty$) and the singular point is called an unstable (resp. stable) spiral (see Fig.6). This will happen in our case if $c \neq 0$ and $c^2 < 4f'(u_0)$.

Case d. The eigenvalues $\lambda_1, \lambda_2 = \bar{\lambda}_1$ are complex conjugates, $\text{Re } \lambda_1 = 0$. Then the singular point is called a *center*. All the trajectories near this point are periodic (see Fig.7). For the nonlinear system this character may easily be disturbed, and the result may be a spiral or a dense family of periodic solutions near the singular point. For an extensive review, see ANDRONOV et

al. [12, Ch.IV] or CODDINGTON & LEVINSON [10, Ch.15].

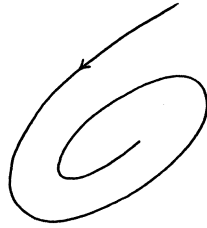

Figure 6

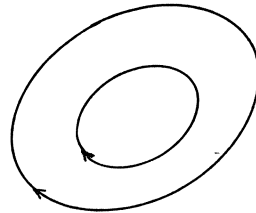

Figure 7

REMARK 2.1. In the sequel an important property of the invariant manifolds will frequently be used, namely continuity with respect to c . If we change c a little, then the corresponding manifolds will lie close together in the phase plane, at least in finite sets. We cannot refer to an explicit formulation and proof of this result in the literature, but a treatment of the related subject of continuity of solutions with respect to parameters can be found in almost every textbook on ordinary differential equations (for example, see CODDINGTON & LEVINSON [10, Ch.2] or HALE [13, p.24]).

2.2. Two singular points, the existence of a travelling wave

From now on we assume that $f(u)$ satisfies (1.3), so $f \in C^1[0,1]$, $f(0) = f(1) = 0$, $f(u) > 0$ in $(0,1)$, $f'(0) > 0$, $f'(1) < 0$. For values of c such that $0 < c < c' = 2\sqrt{f'(0)}$, we cannot expect a front, because in that case $(0,0)$ is a stable spiral, and hence trajectories that approach $(0,0)$ lie partially in the region $u < 0$. Therefore we assume further that $c^2 > 4f'(0)$ (see, for $c^2 = 4f'(0)$, Remark 2.4). If we take $c > 0$ we have at $(0,0)$ a stable two-tangent node and at $(1,0)$ a saddle point with, in this particular case, the direction $\frac{dv}{du} = \lambda_1 > 0$ for the unstable manifold and $\frac{dv}{du} = \lambda_2 < 0$ for the stable manifold at $(1,0)$. These directions can easily be derived by examining the eigenvectors belonging to λ_1, λ_2 . In the same way the directions at the node are $\frac{dv}{du} = \lambda_2$ for the side manifold and $\frac{dv}{du} = \lambda_1$ for

the main direction (see Fig.8).

Now the question arises under which conditions the unstable manifold departing from $(1,0)$ will finally arrive at $(0,0)$. A possible approach is the construction of two piecewise differentiable non-intersecting arcs $v \equiv 0$ and θ connecting the two singular points. Let θ , parametrized by x , be given as follows:

$$\begin{aligned}
 (2.4) \quad & \theta: u = \theta_1(x), \quad v = \theta_2(x), \quad -\infty < x < \infty; \\
 & 0 < \theta_1(x) < 1, \quad \theta_2(x) < 0; \\
 & \theta_1 \rightarrow 0, \quad \theta_2 \rightarrow 0, \quad x \rightarrow \infty; \\
 & \theta_1 \rightarrow 1, \quad \theta_2 \rightarrow \bar{\theta} \leq 0, \quad x \rightarrow -\infty; \\
 & |\dot{\theta}_1| + |\dot{\theta}_2| \neq 0, \quad |\dot{\theta}_1| + |\dot{\theta}_2| \rightarrow 0, \quad |x| \rightarrow \infty; \\
 & -\infty < \lim_{x \rightarrow \infty} \dot{\theta}_2 / \dot{\theta}_1 < 0; \\
 & u \equiv 1 \quad \text{for } \bar{\theta} < v < 0.
 \end{aligned}$$

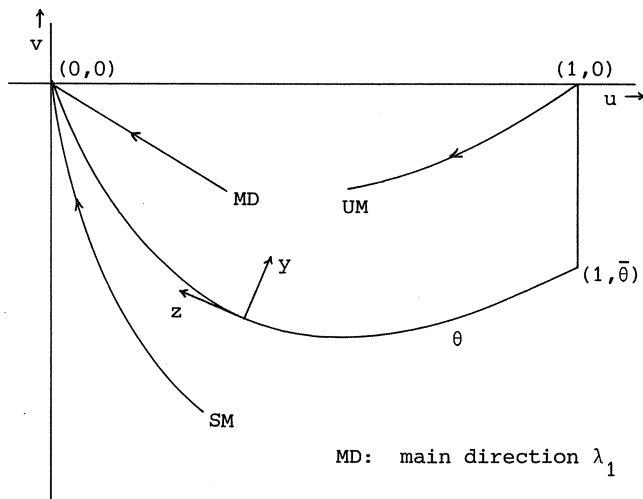

MD: main direction λ_1

SM: side manifold with direction λ_2 at $(0,0)$

UM: unstable manifold

Figure 8

Let B be the domain bounded by $v \equiv 0$, the arc θ , and possibly a segment of the half-line $u \equiv 1, v < 0$. Further, we require that the field (u,v) is directed inward on the boundary of B , while we allow that along the arc θ the field (u,v) is tangent to θ . The conditions therefore are

$$\begin{aligned} & \theta_2 \dot{\theta}_2 + (f(\theta_1) + c\theta_2) \dot{\theta}_1 \geq 0, \quad \text{for all } x \in \mathbb{R}; \\ (2.5) \quad & v < 0 \quad \text{on } u \equiv 1, \quad \bar{\theta} < v < 0; \\ & -f(u) < 0 \quad \text{on } 0 < u < 1, \quad v = 0. \end{aligned}$$

Under our presuppositions we see that only the first condition of (2.5) still remains to be satisfied.

THEOREM 2.2. *Suppose we can find θ such that (2.4), (2.5) are satisfied; then the closed domain \bar{B} contains the unstable manifold of the saddle point $(1,0)$. If continued to $x = \infty$, this trajectory enters the stable node at $(0,0)$. Thus there is a trajectory connecting $(1,0)$ with $(0,0)$.*

By the unstable manifold we mean now the part of the unstable manifold leaving $(1,0)$ into $u < 1, v < 0$.

PROOF.

(1) Suppose a trajectory is in the interior of B at $x = 0$. Then it stays in B for every finite x . For, if $x_0 < \infty$ were the smallest x for which $(u(x_0), v(x_0)) \notin B$, then either $(u_0, v_0) = (u(x_0), v(x_0))$ is one of the singular points, or it is any other boundary point of B . The first case is easily excluded because such a point cannot be reached for finite x . In view of (2.5) the trajectory is tangent to the boundary (or to one of the components of the boundary if the point is a corner). By inspection, the point of tangency can only be on the arc $\theta, 0 < u < 1$. If we change to local coordinates (z,y) (see Fig.8) we get for the equations of the vector field $\frac{dz}{dx} = k(z,y), \frac{dy}{dx} = \ell(z,y)$. Both the arc θ and the trajectory ϕ can be parametrized by z and we have as a consequence of (2.3) and (2.5) (note the change of orientation $(u,v) \rightarrow (z,y)$):

$$\begin{aligned} k(z, \phi(z)) \phi'(z) &= \ell(z, \phi(z)), \\ k(z, \theta(z)) \theta'(z) &\leq \ell(z, \theta(z)). \end{aligned}$$

In view of $\frac{dy}{dx} = 0$, $\frac{dz}{dx} > 0$ at $(z,y) = (0,0)$, we have $\ell(0,0) = 0$, $k(0,0) > 0$. For $F(z,y) = \ell(z,y)/k(z,y)$, $w = \phi - \theta$, we have

$$w'(z) = \phi'(z) - \theta'(z) \geq F(z, \phi(z)) - F(z, \theta(z)) \geq -K|w(z)|, \quad K > 0.$$

Since x_0 was minimal, $w(z) > 0$ for $z < 0$, $w(0) = 0$, say $w(z_1) > 0$,

$z_1 < 0$. It follows that by integrating $w'(z) \geq -Kw(z)$, $\int_{w(z_1)}^{w(0)} dw/w \geq Kz_1$, which provides a contradiction.

- (2) If a trajectory is in ∂B for $x = x_0$, then it stays in \bar{B} for all x . This is obvious if the trajectory is one of the points $(0,0)$, $(1,0)$. Otherwise a similar argument to that in (1) can be used.
- (3) We show that the unstable manifold ϕ is contained in \bar{B} . It is sufficient to show that the unstable manifold is in \bar{B} for $-\infty < x < x_0$ for some finite x_0 . This is trivial for $\bar{\theta} < 0$. Now let $\bar{\theta} = 0$ and let for $x \rightarrow -\infty$ $\dot{\theta}_2/\dot{\theta}_1 < \lambda_1$, otherwise we immediately get a contradiction to (1). Suppose the unstable manifold arrives at some point $P \in \bar{B}$. Choose any $\bar{P} \notin \bar{B}$ between ϕ and θ through \bar{P} for $x \rightarrow -\infty$. For \bar{P} sufficiently close to P the trajectory follows the unstable manifold arbitrarily closely and has common points with the interior of B . Following the trajectory to $-\infty$ we obtain a contradiction, because it necessarily leaves the domain B as a consequence of the local behaviour near a saddle point, which is impossible in view of (1).
- (4) Finally we have to exclude the possibility of a limit cycle inside B . That this is impossible follows from a criterion of BENDIXSON: if the divergence of the field has a fixed sign, then there are no limit cycles (see TEMME [12, p.128]). In our case the divergence reads $-c < 0$. \square

THEOREM 2.3. *The closed domain \bar{B} contains the main direction of the node at $(0,0)$. The side manifold of the node at $(0,0)$ has no points in common with the open domain B .*

PROOF. There are trajectories starting in the interior of B which enter $(0,0)$ in the main direction. If the main direction were not contained in B , these trajectories would leave \bar{B} , which gives a contradiction to Theorem 2.2(1).

Suppose the side manifold has a point P in common with the interior of

B. Then there are trajectories starting in the interior of B , close to P , which enter the node along the two opposite main directions, dependent upon which side of the side manifold they start from. The side manifold is just the separatrix of these trajectories. Some of these must leave \bar{B} , contradicting Theorem 2.2(1). \square

Once we succeed in constructing an arc θ with the desired properties we have by Theorem 2.3 established the existence of a particular solution $\xi_c(x) = (u_c(x), v_c(x))$ of (2.3) with the property $\xi_c(-\infty) = (1,0)$, $\xi_c(+\infty) = (0,0)$. Note that $u_c(x)$ is monotone decreasing, since $\frac{du}{dv} = v < 0$, $0 < u < 1$.

In uniformity with Definition 1.1 we call $\xi_c(x)$ a *front* and c the *speed* of the front.

2.3 Characterization of the speeds of a front

As we have seen above, there exists a front for the equation (2.3) under the conditions which we list again below:

$$(2.6) \quad \begin{aligned} c^2 &> 4f'(0) > 0; & c &> 0; & f'(1) &< 0; \\ f(0) &= f(1) = 0; & f(u) &> 0, & 0 &< u < 1; \end{aligned}$$

and there exists an arc θ , satisfying (2.4), for which we require

$$(2.7) \quad \theta_2 \dot{\theta}_2 + f(\theta_1) \dot{\theta}_1 + c \theta_2 \dot{\theta}_1 \geq 0, \quad \text{for all } x \in \mathbb{R}.$$

REMARK 2.4. For $c = c' = 2\sqrt{f'(0)}$ we have at $(0,0)$ a stable one-tangent node, and in that case there also exists a front if we can satisfy (2.7); note that in Theorem 2.3 the main and side direction are now the same.

From now on we assume (2.6) with $c^2 \geq 4f'(0) > 0$.

THEOREM 2.5. *The set of possible speeds is an upper half-line or empty.*

PROOF. Suppose c_1 is a speed. To c_1 correspond $u_{c_1}(x) = \theta_1(x)$, $v_{c_1}(x) = \theta_2(x)$, $\dot{\theta}_1 = \theta_2$, $\dot{\theta}_2 = -f(\theta_1) - c_1 \theta_2$. For $c > c_1$ it follows that

$$\theta_2 \dot{\theta}_2 + f(\theta_1) \dot{\theta}_1 + c \theta_2 \dot{\theta}_1 = (c - c_1) \theta_2^2 > 0,$$

thus we can satisfy (2.7) with the aid of the arc (u_{c_1}, v_{c_1}) , thus c is a speed. \square

DEFINITION 2.6. $c_0 = \text{infimum of all speeds.}$

Note that $c_0 \geq c'$, $c_0 \leq \infty$.

COROLLARY 2.7. *If c_1, c_2 are speeds, with $c_2 > c_1 \geq c'$, and if (u_{c_1}, v_{c_1}) , (u_{c_2}, v_{c_2}) are the corresponding fronts, then the front (u_{c_2}, v_{c_2}) is contained in the closed domain formed by (u_{c_1}, v_{c_1}) and the u -axis.*

PROOF. The proof follows easily from the fact that (u_{c_1}, v_{c_1}) acts as an arc θ in Theorem 2.2. \square

THEOREM 2.8. *If $c_0 < \infty$, then c_0 is a speed.*

PROOF. Assume c_0 is not a speed. Let $c > c_0$ be any speed with front θ and let B be the domain bounded by θ and the u -axis. An identical calculation to that in the proof of Theorem 2.5 shows that now the vector field for $c = c_0$ points outward along θ . Using the same arguments as in the proof of Theorem 2.2 we see that the unstable manifold ϕ for $c = c_0$ does not enter the open domain B for $0 \leq u \leq 1$, $v \leq 0$. Further, we note that in view of the continuity of $f(u)$ on $0 \leq u \leq 1$ there exists a $v' = v'(c) < 0$ such that $-f(u) - cv' < 0$, $0 \leq u \leq 1$, preventing v from going to minus infinity in $0 \leq u \leq 1$, $v \leq 0$. Thus ϕ arrives at $u = 0$, $v < 0$ for some finite x . But the unstable manifold for $c > c_0$, where $c - c_0$ is sufficiently small, has the same behaviour (see Remark 2.1) which leads immediately to a contradiction, because this c value is a speed. \square

THEOREM 2.9.

(1) *If $c_0 = c'$, then the front corresponding to c_0 enters the one-tangent node $(0,0)$ in the only possible direction.*

(2) *If $c_0 > c'$ is finite, then the front corresponding to c_0 is the side manifold of the two-tangent node at $(0,0)$ with the direction*

$$\lambda_2 = \{-c_0 - \sqrt{c_0^2 - 4f'(0)}\}/2 \text{ at } (0,0).$$

(3) *For $c > c_0$ the front with speed c arrives in the main direction*

$$\lambda_1 = \{-c + \sqrt{c^2 - 4f'(0)}\}/2 \text{ at } (0,0).$$

PROOF.

- (1) See Remark 2.4.
- (2) Let ϕ_0 be the front with speed c_0 and let B be the domain between ϕ_0 and the u -axis. Choose a $c \in (c', c_0)$ with the corresponding unstable manifold ϕ from $(1,0)$; ϕ does not enter the open domain B and does not arrive at $(0,0)$. While for this c the direction of the side manifold of the node at $(0,0)$ is greater than for c_0 , the side manifold is in B and thus separates all other trajectories entering $(0,0)$ from ϕ . For $c \rightarrow c_0$ the trajectory merges with the side manifold before it can meet any other trajectory entering $(0,0)$; again we have here used Remark 2.1.
- (3) Suppose $c_1 > c > c_0$. Let θ, θ_1 be the fronts with speed c, c_1 , and B the domain between θ and the u -axis. By Corollary 2.7 θ_1 is contained in \bar{B} . By Theorem 2.3 the side manifold at $(0,0)$ for c_1 has no points in common with B . Thus, if θ_1 does not arrive in the main direction at $(0,0)$ it will do so in the side direction, and this is only possible if all the trajectories for $c \in [c_0, c_1]$ have identical trajectories on $0 \leq u \leq 1$ (note that by Theorem 2.2 a trajectory from inside B cannot arrive on the boundary of B in finite time). But this last conclusion is not possible by the linear dependence of $\frac{dv}{dx}$ on c . \square

2.4. Bounds for c_0

Let $f(u)$ and c satisfy (2.6). By Theorem 2.5 there is an upper half-line of speeds if we can exclude $c_0 = \infty$. So if we can satisfy (2.7) with $c \geq c'$ the existence of an upper half-line of speeds is proved. In the following subsection we calculate the bounds explicitly, which we shall derive in this subsection.

Since for a front u_c is monotone decreasing we can represent the arc θ in (2.4) in the form $v = \rho(u)$, where $\rho: [0,1] \rightarrow (-\infty, 0]$ is continuously differentiable and satisfies

$$(2.8) \quad \rho(u) < 0, \quad 0 < u < 1; \quad \rho(0) = 0, \quad \rho'(0) < 0.$$

Then condition (2.7) reads $\rho \dot{\rho} + c\rho + f(u) \leq 0$, or, since $\rho < 0$,

$$(2.9) \quad c \geq \sup_{0 < u < 1} \left\{ -\dot{\rho}(u) - \frac{f(u)}{\rho(u)} \right\}.$$

As there exist functions of the required type, the existence of speeds is established, and taking for ρ the function representing the front with speed c_0 the supremum becomes c_0 . Thus:

THEOREM 2.10. *The minimal speed is finite and can be characterized by*

$$(2.10) \quad c_0 = \inf_{\rho} \sup_{0 < u < 1} \left\{ -\dot{\rho}(u) - \frac{f(u)}{\rho(u)} \right\},$$

with $\rho \in C^1[0,1]$, ρ satisfies (2.8).

COROLLARY 2.11. *The minimal speed c_0 satisfies*

$$(2.11) \quad 2\sqrt{f'(0)} = c' \leq c_0 \leq 2\sqrt{L}, \quad L = \sup_{0 < u < 1} \left\{ \frac{f(u)}{u} \right\}.$$

PROOF. Choose $\rho(u) = -\kappa u$, $\kappa > 0$; then $c_0 \leq \kappa + \frac{L}{\kappa}$. Minimize over κ : for $\kappa = \sqrt{L}$ it follows that $c_0 \leq 2\sqrt{L}$. \square

COROLLARY 2.12. *The minimal speed c_0 , for $f(u) = u(1-u)$, reads $c_0 = 2$.*

PROOF. $f'(0) = 1$, $\sup_{0 < u < 1} \left\{ \frac{f(u)}{u} \right\} = 1$; use (2.11). \square

2.5. An example

Now we take for $f(u)$ the example (1.2) from the introduction of this chapter. Writing $\tau = 1 + \tau_2 - \tau_1$, $\sigma = 1 + \tau_2 - \tau_3$, we get $f(u) = u(1-u)(1-\tau-(2-\sigma-\tau)u)$, where σ, τ are the viabilities of the three genotypes. For $\sigma > 1 > \tau$ ("heterozygotes not inferior") and with a simple transformation of the variable x , which affects the value of c , we get $f(u) = u(1-u)(1+vu)$, with $-1 < v = (\sigma-1)/(1-\tau) - 1$. The function f satisfies the requirements of the preceding subsections.

THEOREM 2.13. *The minimal speed for $f(u) = u(1-u)(1+vu)$, $v > -1$, is*

$$c_0 = \begin{cases} 2 & \text{for } -1 < v \leq 2, \\ \frac{v+2}{\sqrt{2v}} & \text{for } v \geq 2. \end{cases}$$

PROOF. From Corollary 2.11 it follows that $f'(0) = 1 \leq \frac{c_0^2}{4} \leq L$, with $L = \sup_{0 < u < 1} \{(1-u)(1+vu)\}$. By examining this parabola we find

$$(2.12) \quad L = \begin{cases} 1 & \text{for } -1 < v \leq 1, \\ \frac{(v+1)^2}{4v} & \text{for } v \geq 1. \end{cases}$$

We now see immediately that $c_0 = 2$, $-1 < v \leq 1$. By direct substitution of the so-called *Huxley pulse*

$$(2.13) \quad u_H(x) = [1 + \exp(\sqrt{v}/2x)]^{-1}$$

in equation (2.1), we find that $u_H(x)$ is a front with corresponding speed $c_H = (v+2)/\sqrt{2v}$. For $v = 2$, $c_H = 2$. Thus for $v = 2$, $c_0 \leq 2$, but by (2.12) it follows that $c_0 = 2$. Since $f(u)$ and thus c_0 increases with v (follows from (2.10), $\rho(u) < 0$), we have $c_0 = 2$ for $1 \leq v \leq 2$. For $v \geq 2$,

$$v_H(x) = \dot{u}_H(x) = -\sqrt{v}/2 \exp(\sqrt{v}/2x) [1 + \exp(\sqrt{v}/2x)]^{-2}$$

and thus $\frac{dv}{du} \rightarrow -\sqrt{v}/2$ for $x \rightarrow \infty$. On the other hand, the slowest front arrives at $(0,0)$ with the side direction

$$\frac{dv}{du} = \lambda_1 = \{-c_0 - \sqrt{c_0^2 - 4}\}/2,$$

which shows that for $v \geq 2$, $c_0 = c_H$ and the Huxley pulse represents the speed corresponding to c_0 for $v \geq 2$. For $-1 < v < 2$ the speed $c_0 = 2$ is known, but the corresponding front is unknown so far. \square

3. STABILITY AND ASYMPTOTIC BEHAVIOUR

In this section we investigate the asymptotic behaviour as $t \rightarrow \infty$ of solutions of the initial value problem for the nonlinear diffusion equation (1.4). The results of the foregoing section will turn out to be very useful. The main technical tool to be used is a comparison theorem based on the max-

imum principle. This theorem was stated and proved in Chapter II (see Theorem II.1.9) but we reformulate it here.

THEOREM 3.1. *Let $D = (a,b) \times (0,T)$, where $-\infty \leq a < b \leq \infty$, $0 < T \leq \infty$. Let $f(u)$ be a continuously differentiable function such that $f'(u)$ is bounded from above on \mathbb{R} . Let u and w satisfy*

$$w_{xx} + cw_x + f(w) - w_t \leq u_{xx} + cu_x + f(u) - u_t \quad \text{in } D,$$

and $w(x,0) \geq u(x,0)$, $x \in (a,b)$. Moreover, if $a > -\infty$ assume that $w(a,t) \geq u(a,t)$, $t \in [0,T)$, and if $b < \infty$ assume that $w(b,t) \geq u(b,t)$, $t \in [0,T)$. Then $w \geq u$ in D and if $w(x,0) > u(x,0)$ in an open sub-interval of (a,b) , then $w > u$ in D .

This theorem does not seem to be applicable to the present problem since, with $f(u)$ given by (1.2), $f'(u)$ is certainly not bounded. However, we can use Theorem 3.1 to show that the set

$$X = \{u \mid u \text{ continuous on } \mathbb{R} \text{ and } 0 \leq u(x) \leq 1\}$$

is invariant with respect to the differential equation

$$(3.1) \quad u_t = u_{xx} + cu_x + f(u).$$

This makes it sensible to formulate a corollary for functions belonging to X (note that $f'(u)$ is bounded on $[0,1]$).

Let $\tilde{f}(u)$ satisfy $\tilde{f}(u) = f(u)$ for $-1 \leq u \leq 2$, $\tilde{f} \in C^1$ and \tilde{f}' is bounded from above on \mathbb{R} . Choose $\psi \in X$ arbitrarily and let $u(x,t)$ be the solution of

$$\begin{aligned} u_t &= u_{xx} + cu_x + \tilde{f}(u), \\ u(x,0) &= \psi(x). \end{aligned}$$

It now follows from Theorem 3.1, since $w \equiv 0$ and $w \equiv 1$ satisfy $w_t = w_{xx} + cw_x + \tilde{f}(w)$, that $u(\cdot, t) \in X$ as long as it is defined. Since $\tilde{f}(u) = f(u)$ for $0 \leq u \leq 1$ we obtain that $u(x,t)$ satisfies (3.1) as well and we have indeed shown that X is invariant. It is worthwhile to note that the

solution, since it cannot become unbounded, is in fact defined for all $t \in (0, \infty)$.

COROLLARY 3.2. *Let $D = (a, b) \times (0, T)$, where $-\infty \leq a < b \leq \infty$, $0 < T \leq \infty$, and let f be continuously differentiable. Let u, w satisfy*

$$w_{xx} + cw_x + f(w) - w_t \leq u_{xx} + cu_x + f(u) - u_t \quad \text{in } D$$

$u(\cdot, 0), w(\cdot, 0) \in X$ and $w(x, 0) \geq u(x, 0)$, $x \in (a, b)$. Moreover, if $a > -\infty$ assume that $w(a, t) \geq u(a, t)$, $t \in [0, T)$ and if $b < \infty$ assume that $w(b, t) \geq u(b, t)$, $t \in [0, T)$. Then $u(\cdot, t), w(\cdot, t) \in X$ for all $t \geq 0$, $w \geq u$ in D and if $w(x, 0) > u(x, 0)$ in an open sub-interval of (a, b) , then $w > u$ in D .

First of all, we are interested in the stability character of the trivial equilibria $u \equiv 0$ and $u \equiv 1$, and in a characterization of their domain of attraction. In Chapter I the stability of equilibria was investigated by means of Lyapunov functionals, and this method will be worked out in much more detail in Chapter V. The same theory applies here (see [5, 14]), but we choose a different approach based on the comparison principle, Corollary 3.2 (with, in the first instance, $c = 0$). The line of thought has already been explained in Chapter III. The keystone of the method is the construction of suitable lower solutions, and the next theorem is an important result in this direction (compare Section III.5).

THEOREM 3.3. *Let $q \in X$ satisfy $q_{xx} + cq_x + f(q) \geq 0$ in (a, b) , where $-\infty \leq a < b \leq \infty$. If $a > -\infty$ assume that $q(a) = 0$, and if $b < \infty$ assume that $q(b) = 0$. Let $u(x, t)$ denote the solution of (3.1) satisfying*

$$u(x, 0) = \begin{cases} q(x) & \text{in } (a, b), \\ 0 & \text{in } \mathbb{R} \setminus (a, b). \end{cases}$$

Then $u(x, t)$ is a nondecreasing function of t for each x . Moreover, $\lim_{t \rightarrow \infty} u(x, t) = \tau(x)$ uniformly in each bounded x -interval, where $\tau(x)$ is the smallest solution of $\tau_{xx} + c\tau_x + f(\tau) = 0$, $-\infty < x < \infty$, which satisfies $\tau \in X$ and $\tau(x) \geq q(x)$ in (a, b) .

PROOF. From Corollary 3.2 it follows that $u(x,h) \geq u(x,0)$ for all $h > 0$. Another application of Corollary 3.2 now yields $u(x,t+h) \geq u(x,t)$ for any $h > 0$. Thus, for each x , $u(x,t)$ is nondecreasing in t and bounded above, and therefore $\lim_{t \rightarrow \infty} u(x,t) = \tau(x)$ exists. Since the space domain is unbounded the conclusion that τ indeed satisfies $\tau_{xx} + c\tau_x + f(\tau) = 0$ cannot be drawn from Theorem III.2.12 directly. One can adapt the proof of that theorem, but in this particular case of a one-dimensional space domain the following proof using the Green's function is much easier. The idea is to prove that u_x , u_{xx} and u_t are equicontinuous and uniformly bounded, and then to apply the Arzela-Ascoli Theorem.

Let

$$(3.2) \quad E_c(x,t) = \frac{1}{2\sqrt{\pi t}} \exp\left\{-\frac{1}{4t}(x+ct)^2\right\};$$

then

$$(3.3) \quad u(x,t+T) = \int_{-\infty}^{\infty} E_c(x-y,t)u(y,T)dy + \int_0^t \int_{-\infty}^{\infty} E_c(x-y,t-\tau) f(u(y,\tau+T))dy d\tau.$$

We know that $u(\cdot, t) \in X$ for all $t \geq 0$ and therefore, by putting $\|f\| = \max_{u \in [0,1]} |f(u)|$,

$$\begin{aligned} |u_x(x,t+T)| &\leq \int_{-\infty}^{\infty} \left| \frac{\partial}{\partial x} E_c(x-y,t) \right| dy + \\ &\quad + \|f\| \int_0^t \int_{-\infty}^{\infty} \left| \frac{\partial}{\partial x} E_c(x-y,t-\tau) \right| dy d\tau. \end{aligned}$$

Since

$$\int_{-\infty}^{\infty} \left| \frac{\partial}{\partial x} E_c(x-y,t) \right| dy = \frac{1}{\sqrt{\pi t}},$$

we obtain

$$|u_x(x, t+T)| \leq \frac{1}{\sqrt{\pi t}} + 2\|f\| \sqrt{\frac{t}{\pi}},$$

and finally

$$|u_x(x, T)| < k_1 \quad \text{for all } x \in \mathbb{R} \text{ and } T \geq \delta > 0.$$

We need a similar estimate for u_{xx} . Since $f \in C^1$, $w(x, t) = u_x(x, t)$ satisfies

$$w_t = w_{xx} + cw_x + f'(u)w,$$

and thus

$$\begin{aligned} w(x, t+T) &= \int_{-\infty}^{\infty} E_C(x-y, t) w(y, T) dy + \\ &+ \int_0^t \int_{-\infty}^{\infty} E_C(x-y, t-\tau) f'(u(y, \tau+T)) w(y, \tau+T) dy d\tau. \end{aligned}$$

Hence

$$|w_x(x, t+T)| \leq \frac{k_1}{\sqrt{\pi t}} + 2\alpha k_1 \sqrt{\frac{t}{\pi}},$$

where

$$\alpha = \max_{u \in [0, 1]} |f'(u)|,$$

and thus

$$|u_{xx}(x, T)| < k_2 \quad \text{for all } x \in \mathbb{R} \text{ and } T \geq \delta > 0.$$

So u_x and u_{xx} are uniformly bounded, and by (3.1) the same must be true for u_t . From (3.3) it follows that the families of functions of x , $\{u_x(x,t) \mid t \geq \delta > 0\}$ and $\{u_{xx}(x,t) \mid t \geq \delta > 0\}$ are equicontinuous, and again by (3.1) the same follows for $\{u_t(x,t) \mid t \geq \delta > 0\}$. By the Arzela-Ascoli Theorem we know that on each bounded x -interval these families have a non-empty limit set as $t \rightarrow \infty$. But, since u converges to τ , u_x , u_{xx} and u_t necessarily converge to the corresponding derivatives of τ uniformly on each bounded x -interval, and thus τ satisfies $\tau_{xx} + c\tau_x + f(\tau) = 0$. Obviously $\tau \in X$ and $\tau(x) \geq q(x)$ in (a,b) . It remains to show that τ is the smallest solution with these properties. Let σ be any other such function. Then $u(x,0) \leq \sigma(x)$, and hence by Corollary 3.2 $u(x,t) \leq \sigma(x)$ and therefore also $\tau(x) \leq \sigma(x)$. \square

We are now ready to prove the first main result (compare Corollary III.5.3).

THEOREM 3.4. *Let $u(x,t)$ be a solution of (3.1) with $u(\cdot,0) \in X$. Then either $u(x,t) \equiv 0$ or $\lim_{t \rightarrow \infty} u(x,t) = 1$.*

PROOF. Suppose $u(x,0) \not\equiv 0$; then by Corollary 3.2 $u(x,h) > 0$ for any $h > 0$. Since $f'(0) > 0$ we have $f(q) \geq \frac{1}{2}f'(0)q$ for q positive and sufficiently small, say $0 \leq q \leq \bar{q}$. Let $q^\epsilon(x) = \epsilon \sin \lambda x$ with $\lambda^2 = \frac{1}{2}f'(0)$; then $q_{xx}^\epsilon + f(q^\epsilon) \geq 0$ for $0 \leq \epsilon \leq \bar{q}$ and $0 \leq x \leq \frac{\pi}{\lambda}$. Now choose ϵ so small that $u(x,h) \geq q^\epsilon(x)$ for $0 \leq x \leq \frac{\pi}{\lambda}$. It then follows from Theorems 3.2 and 3.3 that

$$\liminf_{t \rightarrow \infty} u(x,t) = \liminf_{t \rightarrow \infty} u(x,t+h) \geq \tau(x),$$

where $\tau(x)$ is the smallest solution of $\tau_{xx} + f(\tau) = 0$ which satisfies $\tau \in X$ and $\tau(x) \geq q^\epsilon(x)$ in $[0, \frac{\pi}{\lambda}]$. From a plot of trajectories in the phase plane (see Figure 9; $(0,0)$ is a center for the linearized system and (3.1) is conservative for $c = 0$; see [13;Section V.1]) it follows readily that $\tau(x) = 1$, and hence $\lim_{t \rightarrow \infty} u(x,t) = 1$. \square

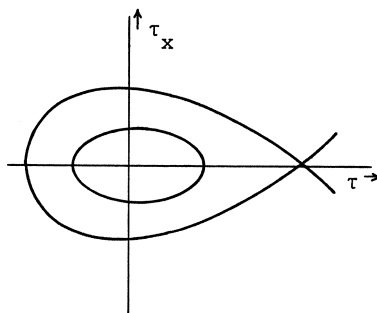

Figure 9

Theorem 3.4 tells us that whatever initial function $\psi \in X$, $\psi \neq 0$, we take, the solution approaches $u \equiv 1$. Or, in other words, the intersection of the domain of attraction of $u \equiv 1$ with X is precisely $X \setminus \{u \equiv 0\}$.

So far we have used Theorem 3.3 only with $c = 0$. The next step is to investigate how $u(x,t)$ approaches $u \equiv 1$, and then the results of Section 2 together with Theorem 3.3 with $c \neq 0$ are useful.

In general, the way in which $u(x,t)$ approaches $u \equiv 1$ depends on the initial function $u(x,0)$, especially on the behaviour for $|x| \rightarrow \infty$. The first result in this direction was given by KOLMOGOROFF et al. [3]. They proved, under certain restrictions for f , that the solution of (3.1) with $u(x,0) = \theta(x)$ (the Heaviside step function) converges in the sense described in Section 1 towards the travelling front solution with minimal speed c_0 . This result of Kolmogoroff et al. is substantially generalized by ROTHE [5]. In the remaining part of this section we consider some results of ARONSON & WEINBERGER [9], which are of a somewhat different nature. The conclusions concern the asymptotic speed of propagation but not the asymptotic form (they do not yield convergence towards a travelling front solution).

THEOREM 3.5. *Let $u(x,t)$ be a solution of (1.4) with $u(\cdot,0) \in X$. If for some x_0 , $u(x,0) \equiv 0$ in (x_0, ∞) , then for each ξ and each $c > c_0$,*

$$\lim_{t \rightarrow \infty} u(\xi + ct, t) = 0.$$

PROOF. Choose $c > c_0$. We recall and extend some results from Section 2. We know that the unstable manifold ϕ_c from $(1,0)$ enters $(0,0)$ in the main direction (Theorem 2.9).

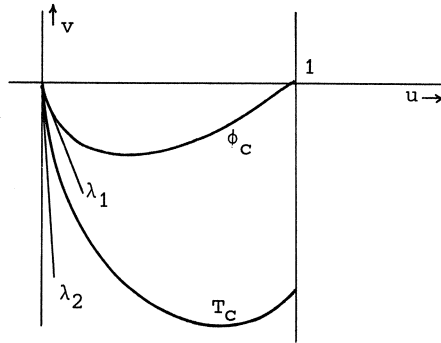

Figure 10

Let T_c denote the unique trajectory which enters $(0,0)$ in the side direction out of the quarter plane $\{(u,v) \mid u \geq 0, v \leq 0\}$. We claim that T_c connects $(0,0)$ with a point of the form $(1,-v)$, with $v > 0$. Consider the set $R = \{(u,v) \mid 0 < u < 1, v < 0\}$. From $u_x = v$ it follows that T_c cannot tend to infinity in R , and therefore T_c has to cross the boundary of R somewhere. We exclude several possibilities:

- (i) T_c cannot cross $u = 0, v < 0$, because there the vector field $(v, -cv - f(u))$ is pointing outward from R .
- (ii) T_c cannot cross ϕ_c and hence cannot cross $v = 0, 0 < u < 1$.
- (iii) $(1,0)$ is a saddlepoint and T_c is not the unstable manifold. It follows that T_c cannot go through $(1,0)$.

Hence T_c enters R through the part of the boundary with $u = 1, v < 0$. Let $q_c(x)$ denote the solution of (3.1) which corresponds to T_c and for which $q_c(0) = 1$; then q_c is decreasing and approaches zero as $x \rightarrow \infty$. Putting $w \equiv 1 - u$ and $q(\xi) = 1 - q_c(\xi - x_0)$, we now apply Theorems 3.2 and 3.3 with $(a,b) = (x_0, \infty)$ to the equation $w_t = w_{\xi\xi} + cw_\xi - f(1-w)$. It follows that

$$\liminf_{t \rightarrow \infty} (1 - u(\xi + ct, t)) \geq 1 - \tau(\xi),$$

where $\tau(\xi)$ satisfies $\tau_{\xi\xi} + c\tau_\xi + f(\tau) = 0$ and τ is maximal with respect to the properties

$$(3.4) \quad \tau(\xi) \leq 1, \quad -\infty < \xi < \infty,$$

$$(3.5) \quad \tau(\xi) \leq q_c(\xi - x_0), \quad x_0 < \xi < \infty.$$

The assertion of the theorem follows if we can prove that $\tau(\xi) \equiv 0$. Suppose $\tau(\xi) \not\equiv 0$. Let T denote the trajectory corresponding to τ . Then either $T = T_c$ or T enters $(0,0)$ in the main direction. The possibility $T = T_c$ is excluded since then for some $\xi < 0$ we would have $\tau(\xi) > 1$, in contradiction to (3.4). Finally, if T enters $(0,0)$ in the main direction, then $\tau(\xi) \sim \exp \lambda_1 \xi$ as $\xi \rightarrow \infty$, whereas $q_c(\xi - x_0) \sim \exp \lambda_2 \xi$ as $\xi \rightarrow \infty$. Since $\lambda_2 < \lambda_1 < 0$ this would imply $\tau(\xi) > q_c(\xi - x_0)$ for ξ sufficiently large, in contradiction to (3.5). \square

REMARK 3.6. The equation (1.4) is invariant when x is replaced by $-x$. So if $u(x,0) \equiv 0$ in some interval $(-\infty, x_0)$ we may conclude that $\lim_{t \rightarrow \infty} u(\xi + ct, t) = 0$ for each ξ and each $c < -c_0$. Combining the two cases we obtain: if $u(x,0)$ has compact support, then $\lim_{t \rightarrow \infty} u(\xi + ct, t) = 0$ for each ξ and each c with $|c| > c_0$.

THEOREM 3.7. Let $u(x,t)$ be a solution of (1.4) with $u(\cdot, 0) \in X$. If $u(x,t) \not\equiv 0$, then for each c with $|c| < c_0$ and each ξ ,

$$\lim_{t \rightarrow \infty} u(\xi + ct, t) = 1.$$

PROOF. The idea of the proof is again to apply Theorem 3.3, so firstly we have to show the existence of a suitable solution, $q(x)$, of (3.1). If $c \in (0, 2\sqrt{f'(0)})$, then $(0,0)$ is a spiral point and consequently there are trajectories satisfying $0 \leq u < 1$ and connecting the positive v -axis to the negative v -axis. Suppose $c_0^2 > 4f'(0)$ and consider any c with $2\sqrt{f'(0)} \leq c < c_0$. Let T_c be defined as in the proof of Theorem 3.5. We recall from Section 2 that T_{c_0} corresponds to a front (Theorem 2.9). As in the proof of Theorem 2.5 it follows that along T_{c_0} the vector field $(v, -cv - f(u))$ is pointing outward from the region bounded by T_{c_0} and $v = 0$, and consequently T_c lies above T_{c_0} in $R = \{(u,v) \mid 0 < u < 1, v < 0\}$.

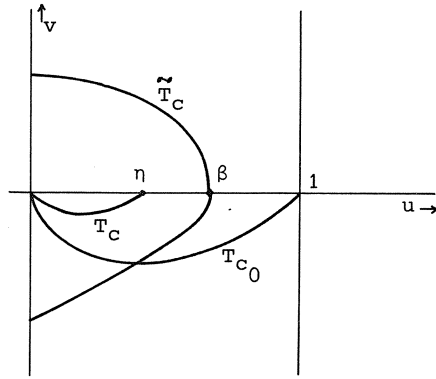

Figure 11

Hence T_c crosses the u -axis at a point $(\eta, 0)$ with $0 < \eta < 1$. Choose β with $\eta < \beta < 1$ and let \tilde{T}_c denote the trajectory through $(\beta, 0)$. Then in the set R , \tilde{T}_c stays below T_c and therefore crosses the negative v -axis. From

$$\frac{dv}{du} = -c - \frac{f(u)}{v},$$

we note that, since $f(u) > 0$ in $0 < u < 1$, the slope of \tilde{T}_c is negative if $v > 0$, $0 < u < 1$, and bounded when v is bounded away from zero. Hence \tilde{T}_c crosses the positive v -axis as well.

So, for each c with $0 < c < c_0$ there is a trajectory \tilde{T}_c which connects the positive v -axis to the negative v -axis through the region $\{(u, v) \mid 0 \leq u < 1\}$. Let \tilde{q}_c be the corresponding solution of (3.1) with $\tilde{q}_c(0) = 0$, $\tilde{q}_c'(0) > 0$; then \tilde{q}_c satisfies $0 \leq \tilde{q}_c \leq \beta < 1$ on a finite interval $(0, b)$ and $\tilde{q}_c(b) = 0$.

Let $u(x, t)$ satisfy the hypotheses of the theorem. From Theorem 3.4 we conclude that $\lim_{t \rightarrow \infty} u(x, t) = 1$ and the convergence is in fact uniform on every bounded x -interval. Therefore a time t_0 exists so that $u(x, t_0) \geq \beta \geq \tilde{q}_c(x)$ on $[0, b]$, and now application of the Theorems 3.2 and 3.3 yields the desired conclusion for $0 < c < c_0$. The case $-c_0 < c < 0$ is obtained by replacing x by $-x$. \square

Theorems 3.5 and 3.7 make it tempting to call c_0 the asymptotic speed of propagation associated with equation (1.4).

4. RESULTS FOR SOURCE TERMS WITH A SIGN CHANGE

In this section we will study once more the problem

$$(4.1) \quad \begin{aligned} u_t &= u_{xx} + f(u), & -\infty < x < \infty, & \quad t > 0, \\ u(x,0) &= \psi(x), & 0 \leq \psi(x) \leq 1, \end{aligned}$$

but now for another class of functions f , namely

$$(4.2) \quad \begin{aligned} f &\in C^1[0,1], & f(0) = f(1) = f(\alpha) = 0, & \quad 0 < \alpha < 1, \\ f(u) &< 0 \text{ in } (0,\alpha), & f(u) > 0 \text{ in } (\alpha,1), \\ f'(0) &< 0, & f'(\alpha) > 0, & \quad f'(1) < 0, \\ & \int_0^1 f(u) du > 0. \end{aligned}$$

This corresponds to the case $\tau_3 \leq \tau_1 < \tau_2$ in formula (1.2) (and using the substitution in Subsection 2.5 we get $\sigma \geq \tau > 1$), which is known as the "heterozygote inferiority" - case in the population genetic literature. Further this choice also represents a model for a nerve which has been treated with toxins; u then stands for a voltage (see Chapter VII). The last property in (4.2) of the function f is only a kind of normalization, in view of the transformation $v = 1 - u$.

As before we will investigate the stability of the equilibrium solutions and their domains of attraction. We will now encounter a typical example of a threshold phenomenon (compare Theorem 4.2 with Theorem 4.4). Regarding travelling front solutions we will prove the existence of a unique speed c for which a travelling front (see Definition 1.1) exists, and using this front, we formulate analogues of Theorems 3.5 and 3.7. Besides, it is now possible to prove that under certain conditions on the initial function, the approach towards the equilibrium solution is accompanied by the approach towards a travelling front solution. The speed of this front is unique, but the initial function will determine the translation of the argument, which is still a degree of freedom (see Theorem 4.9, a recent result of FIFE & McLEOD [6], [16]).

4.1. Threshold phenomena

As an introductory remark we note that Theorem 3.1 is not dependent on the sign of the source term function f and that in Theorems 3.2, 3.3 it is only necessary to require $f(0) = f(1) = 0$. So these theorems apply to functions with properties (4.2) as well. In section 3 it was shown that of the two equilibrium solutions $u \equiv 0$, $u \equiv 1$ the last was globally (with respect to X) asymptotically stable (Theorem 3.4); recall that

$$X = \{u \mid u \text{ continuous on } \mathbb{R} \text{ and } 0 \leq u(x) \leq 1\}.$$

Now we have three space independent equilibrium solutions $u \equiv 0$, $u \equiv \alpha$, $u \equiv 1$. We will prove that both $u \equiv 0$, and $u \equiv 1$ are stable, and that $u \equiv \alpha$ is unstable. So we can expect threshold phenomena.

Besides the constant equilibrium solutions there is a multitude of non-constant solutions of

$$(4.3) \quad u_{xx} + f(u) = 0,$$

with $f(u)$ satisfying (4.2). This can easily be seen as follows. Multiply (4.3) by u_x , and integrate with respect to x :

$$\frac{1}{2}u_x^2 \Big|_{x=x_0}^{x=x} + \int_{u(x_0)}^{u(x)} f(w)dw = 0$$

or

$$\frac{1}{2}u_x^2 + F(u) = \frac{1}{2}u_x^2(x_0) + F(u(x_0)) = k$$

with $F(u) = \int_0^u f(w)dw$. Choose x_0 , $-\infty \leq x_0 \leq \infty$, such that $u_x(x_0) = 0$, then $k = F(u(x_0))$ and $\frac{1}{2}u_x^2 = k - F(u)$, which defines a curve in the (u, u_x) -plane, symmetric with respect to the u -axis. Define κ by

$$(4.4) \quad \int_0^\kappa f(u)du = 0,$$

i.e., $F(\kappa) = 0$. The function $F(u)$ is qualitatively sketched in Fig.12. We can distinguish the following cases:

- (i) $F(\alpha) < k < 0$ to these values of k corresponds a closed curve in the phase plane (see Fig.13), representing a periodic solution,
- (ii) $k = 0$ the corresponding curve is the stable and the unstable manifold of $(0,0)$ which merge and which we call $\phi(x)$,
- (iii) $0 < k < F(1)$ the corresponding curves represent solutions, which satisfy only for a bounded interval of x the requirement $0 \leq u(x) \leq 1$,
- (iv) $k = F(1)$ if we choose $x_0 = \infty$, $x_0 = -\infty$ respectively the corresponding curves are the stable and the unstable manifold of $(1,0)$.

Except in case (iv) it is always possible to choose $x_0 = 0$. Let $\beta = u(0)$ then we denote the corresponding solutions of (i), (ii) and (iii) by $q_\beta(x)$, thus $F(u(0)) = F(\beta) = k$, $q_\beta(0) = \beta$, $\frac{d}{dx}q_\beta(0) = 0$. From this notation it follows $\phi(x) = q_k(x)$, with the property $\lim_{x \rightarrow \pm\infty} \phi(x) = 0$, $\phi(x)$ monotonely increasing, $x < 0$, monotonely decreasing, $x > 0$. We find in case iii) for $-\ell_\beta < x < \ell_\beta$, $q_\beta(x) > 0$ and $q_\beta(\pm\ell_\beta) = 0$, with

$$\ell_\beta = \int_0^\beta \frac{1}{\sqrt{2(F(\beta) - F(u))}} du,$$

and $\frac{d}{dx}q_\beta(-\ell_\beta) = \sqrt{2F(\beta)}$, $\frac{d}{dx}q_\beta(\ell_\beta) = -\sqrt{2F(\beta)}$.

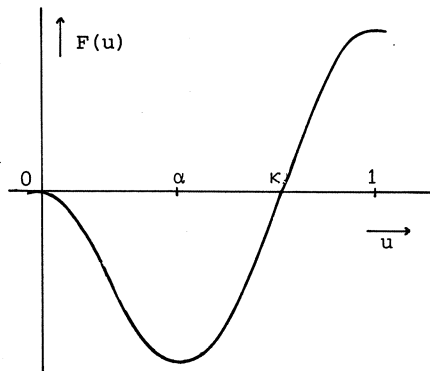

Figure 12

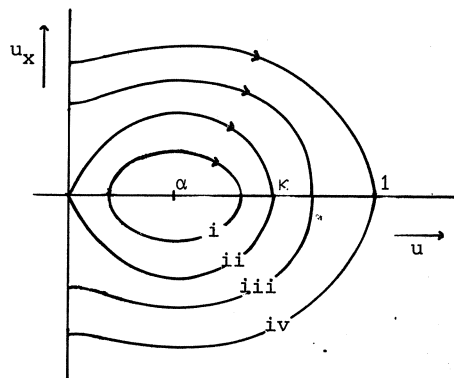

Figure 13

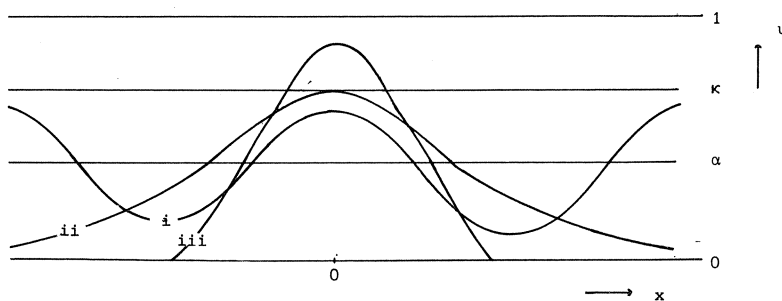

Figure 14

In Fig.14 we have sketched a few examples.

THEOREM 4.1. Let $u(x,t)$ be a solution of (4.1), (4.2) with $u(\cdot,0) \in X$. If $0 \leq u(x,0) \leq \beta_1$, $\beta_1 < \alpha$ then $\lim_{t \rightarrow \infty} u(x,t) = 0$, uniformly on \mathbb{R} . If $\beta_2 \leq u(x,0) \leq 1$, $\beta_2 > \alpha$ then $\lim_{t \rightarrow \infty} u(x,t) = 1$, uniformly on \mathbb{R} .

PROOF. Let v be the solution of the initial value problem $v_t = v_{xx} + f(v)$, $v(x,0) = \beta_i$, $i = 1,2$, then v is independent of x and v satisfies the relation

$$t = \int_v^{\beta_1} \left(\frac{-1}{f(w)} \right) dw, \quad i = 1; \quad t = \int_{\beta_2}^v \left(\frac{1}{f(w)} \right) dw, \quad i = 2.$$

so in both cases the integrand will be positive, $0 < v \leq \beta_1$ respectively $\beta_2 \leq v < 1$ and for $t \rightarrow \infty$ it follows that $v \rightarrow 0$, $i = 1$, $v \rightarrow 1$, $i = 2$. Since $v(x,0) \geq u(x,0)$, $i = 1$, $v(x,0) \leq u(x,0)$, $i = 2$ the assertion follows from Corollary 3.2. \square

Example. Taking for $f(u)$ the polynomial of lowest order, having properties (4.2), namely $f(u) = u(1-u)(u-\alpha)$, $0 < \alpha < \frac{1}{2}$, we find the implicit relation

$$e^{-\alpha(1-\alpha)t} = \left(\frac{\beta_i^{(1-\alpha)} (1-\beta_i)^\alpha}{(\beta_i - \alpha)} \right)^{-1} \frac{u^{1-\alpha} (1-u)^\alpha}{(u-\alpha)}$$

We now give another partial characterization of the domain of attraction of the equilibrium state $u \equiv 0$. Define the function $s(\rho)$, as follows

$$s(\rho) = \sup_{\alpha < u < 1} \frac{f(u)}{u-\rho}, \quad 0 \leq \rho < \alpha.$$

$s(\rho)$ represents the direction of the tangent line to the function $f(u)$, passing through $u = \rho$ with the greatest slope. We use the notation $[\mu]^+ = \max\{0, \mu\}$.

THEOREM 4.2. *Let $u(x,t)$ be a solution of (4.1), (4.2) with $u(\cdot, 0) \in X$. If for some $\rho \in [0, \alpha)$ and $\beta > 0$*

$$\sup_{-\infty < x < \infty} \int_{-\infty}^{\infty} e^{-\frac{(x-\xi)^2}{4\beta}} s(\rho) [\psi(\xi) - \rho]^+ d\xi < \frac{2\sqrt{\pi\beta}}{\sqrt{s(\rho)} e^{\beta}} (\alpha - \rho)$$

then $\lim_{t \rightarrow \infty} u(x,t) = 0$, uniformly on \mathbb{R} .

PROOF. Fix ρ , and write s for $s(\rho)$. Let $w(x,t)$ denote the solution of the problem

$$\begin{aligned} w_t &= w_{xx} + sw \\ w(x,0) &= [\psi(x) - \rho]^+. \end{aligned}$$

By Theorem 3.1 $w \geq 0$, so $w = [w]^+$. Since $f(u) \leq 0$ on $[0, \alpha]$, it follows from the definition of $s(\rho)$ that $f(u) \leq s[u - \rho]^+$. Let $v(x,t) = u(x,t) - \rho$, then we have

$$\begin{aligned} w_{xx} + s[w]^+ - w_t &= w_{xx} + sw - w_t = 0 = \\ u_{xx} + f(u) - u_t &\leq u_{xx} + s[u - \rho]^+ - u_t = v_{xx} + s[v]^+ - v_t, \end{aligned}$$

and

$$w(x,0) = [\psi(x) - \rho]^+ \geq \psi(x) - \rho = v(x,0).$$

We cannot apply Theorem 3.1 since $s[v]^+$ is not continuously differentiable. But by looking at the proof of Theorem II.1.9 from which Theorem 3.1 was borrowed, one may conclude that all that we really need is that

$$g(w,v) = (s[w]^+ - s[v]^+) / (w-v)$$

is bounded. It means that $s[v]^+$ should be Lipschitz continuous (see also Remark II.1.12), which is obviously the case. So $w(x,t) \geq v(x,t)$, for all t , and therefore $u(x,t) \leq w(x,t) + \rho$. The function $\bar{w}(x,t) = w(x,t)e^{-st}$ satisfies the problem $\bar{w}_t = \bar{w}_{xx}$, $\bar{w}(x,0) = w(x,0) = [\psi(x) - \rho]^+$, for which the explicit solution reads

$$w(x,t) = w(x,t)e^{-st} = \frac{1}{2\sqrt{\pi t}} \int_{-\infty}^{\infty} e^{-\frac{(x-\xi)^2}{4t}} [\psi(\xi) - \rho]^+ d\xi.$$

For $t = \frac{\beta}{s}$ we have

$$w(x, \frac{\beta}{s}) = \frac{e^{\beta\sqrt{s}}}{2\sqrt{\pi\beta}} \int_{-\infty}^{\infty} e^{-\frac{(x-\xi)^2}{4\beta}} s [\psi(\xi) - \rho]^+ d\xi < \alpha - \rho$$

so $u(x, \frac{\beta}{s}) < \alpha - \rho + \rho = \alpha$ for all x . Apply Theorem 4.1 to find $\lim_{t \rightarrow \infty} u(x,t) = 0$, uniformly on \mathbb{R} . \square

COROLLARY 4.3. *Let $u(x,t)$ be a solution of (4.1), (4.2) with $u(\cdot, 0) \in X$. If for some $\rho \in [0, \alpha)$*

$$\int_{-\infty}^{\infty} [\psi(\xi) - \rho]^+ d\xi < \sqrt{\frac{2\pi}{se}} (\alpha - \rho)$$

then $\lim_{t \rightarrow \infty} u(x,t) = 0$, uniformly on \mathbb{R} .

PROOF. The left hand part of the inequality in Theorem 4.2 can be majorized for all β by estimating the exponential factor by 1, while the right hand part is maximal for $\beta = \frac{1}{2}$. \square

We will now characterize partially the domain of attraction of the solution $u \equiv 1$.

THEOREM 4.4. *Let $u(x,t)$ be a solution of (4.1), (4.2) with $u(\cdot, 0) \in X$. If for some $\beta \in (\kappa, 1)$ and some x_0 $u(x,0) \geq q_\beta(x-x_0)$ on $(x_0 - \ell_\beta, x_0 + \ell_\beta)$ then $\lim_{t \rightarrow \infty} u(x,t) = 1$ uniformly on each bounded x -interval.*

PROOF. Application of Theorem 3.3 with $q(x) = q_\beta(x)$ yields that for the solution $u(x,t)$ with the given initial condition $\lim_{t \rightarrow \infty} u(x,t) \geq \tau(x)$, uniformly on each bounded x -interval, where $\tau(x)$ is the smallest solution of $\tau_{xx} + f(\tau) = 0$, $-\infty < x < \infty$, which satisfies $\tau \in X$ and $\tau(x) \geq q_\beta(x)$ in $(x_0 - \ell_\beta, x_0 + \ell_\beta)$. As we have seen, the only solution with this property is $\tau(x) \equiv 1$, and we have obtained the desired conclusion. \square

We have shown that a disturbance of bounded support of the state $u \equiv 0$, which is sufficiently large on a sufficiently large interval grows to one, while a disturbance, not necessarily of bounded support, which is not sufficiently large on a sufficiently large interval dies out. So we have obtained a threshold result. Note that there are solutions, corresponding to the periodic ones, which do not belong to either class. The union of the domains of attraction of the equilibrium states $u \equiv 0$, $u \equiv 1$ is not X .

4.2. Travelling fronts

In this subsection we are interested in travelling front solutions of (4.1), (4.2), i.e., solutions of the form $u(x,t) = w(x-ct,t)$ where w satisfies

$$(4.5) \quad \begin{aligned} w_t &= w_{\xi\xi} + cw_{\xi} + f(w), & \xi &= x-ct, \\ w(\xi,0) &= \psi(\xi). \end{aligned}$$

Writing u for the solution of the stationary problem

$$(4.6) \quad u_{xx} + cu_x + f(u) = 0,$$

we recall that we have called u a front (see Definition 1.1), if $u(-\infty) = 1$, $u(\infty) = 0$. Using the remarks of Section 2 we find at the singular points in the (u, u_x) -plane $(0,0)$ and $(1,0)$ a saddle, while there is a stable node at $(\alpha, 0)$, $c \geq \sqrt{4f'(\alpha)}$, an unstable node for $c \leq -\sqrt{4f'(\alpha)}$, a spiral for values of c , $c \neq 0$ in between and a center for $c = 0$. For initial data u , $\alpha \leq u \leq 1$ we have the same situation as in Section 2, so we get a half-line $[c_0, \infty)$ of speeds corresponding to monotonely decreasing fronts with conditions $u(-\infty) = 1$, $u(\infty) = \alpha$. An a priori bound for c_0 is provided by Corollary 2.11: $c_0 \geq 2\sqrt{f'(\alpha)}$. The transformation $v = 1-u$ yields $v_{xx} + cv_x + g(v) = 0$, where $g(v) = -f(1-v)$ has the same properties as $f(u)$. Now the same reasoning applies as above, so there is a half-line $[\bar{c}_0, \infty)$ of monotonely decreasing fronts with conditions $v(-\infty) = 1$, $v(\infty) = 1-\alpha$. A bound for \bar{c}_0 is $\bar{c}_0 \geq 2\sqrt{g'(1-\alpha)} = 2\sqrt{f'(\alpha)}$. Properly translated this means monotonely increasing fronts with $u(-\infty) = 0$, $u(\infty) = \alpha$. So for $c \geq c_0$ the unstable manifold of $(1,0)$ arrives at $(\alpha, 0)$, while for $c \leq -\bar{c}_0$ the stable manifold of $(0,0)$ originated in $(\alpha, 0)$ (change x to $-x$ to see this). So it is reasonable to expect

that for some value c , the unstable manifold of $(1,0)$ merges with the stable manifold of $(0,0)$. Indeed we have

THEOREM 4.5. *For the equation (4.6) there exists a unique speed c_1 , $-\bar{c}_0 < c_1 < c_0$, to which corresponds a monotonely decreasing front u with $u(-\infty) = 1$, $u(\infty) = 0$.*

PROOF. For $c = c_0$ the unstable manifold of $(1,0)$ enters $(\alpha,0)$ for $x \rightarrow \infty$. As in subsection 2.4 we construct an arc θ in the form $v = u_x = \rho(u)$, where $\rho: [0,1] \rightarrow (-\infty,0]$ is continuously differentiable and satisfies $\rho(u) < 0$, $0 < u < 1$, $\rho(0) = \rho(1) = 0$, $\rho'(0) < 0$, $\rho'(1) > 0$. Let again B be the domain formed by ρ and the u -axis. The requirement that the field is directed outward along the arc θ yields $\rho\dot{\rho} + c\rho + f(u) \geq 0$, so for a fixed \bar{c} , since $\rho < 0$, with

$$(4.7) \quad \bar{c} \leq \inf_{0 < u < 1} \left\{ -\dot{\rho}(u) - \frac{f(u)}{\rho(u)} \right\},$$

we see that the unstable manifold $U_{\bar{c}}$ of $(1,0)$ cannot enter B , whereas the stable manifold of $(0,0)$ is contained in \bar{B} . So $U_{\bar{c}}$ does not arrive at $(0,0)$. In view of $\frac{dv}{du} \approx -\bar{c}$ for large values of v , either positive or negative, $U_{\bar{c}}$ arrives at $u = 0$, $v < 0$ for a finite x . Now reduce the value of c from c_0 on: for $c = c_0$ U_c goes to $(\alpha,0)$. For c values slightly less than c_0 , U_c will cross the u -axis between 0 and α , for $c = \bar{c}$ U_c crosses the negative v -axis. So in view of Remark 2.1 there will be a value c_1 , $\bar{c} < c_1 < c_0$ so that U_{c_1} arrives at $(0,0)$. It remains to show that c_1 is unique. Let now $v = \rho(u)$ represent the arc U_{c_1} , then for an arbitrary c , $c \neq c_1$ the field direction along this arc will be

$$-\rho\dot{v} - f(u) - cv = \left(c_1 + \frac{f(u)}{v} \right)v - f(u) - cv = (c_1 - c)v = (c_1 - c)\rho.$$

For $c < c_1$ this direction is negative, so the field points outward, while for $c > c_1$ the field points inward. This means that for $c < c_1$ the stable manifold of $(0,0)$ is contained in B , and the unstable manifold of $(1,0)$ is not, while for $c > c_1$ the opposite holds. So there can be no connection between $(0,0)$ and $(1,0)$, for $c \neq c_1$. \square

REMARK 4.6. From the last property in (4.2) of the function f , i.e. $\int_0^1 f(u) du > 0$, we deduce that necessarily $c_1 > 0$. Suppose the contrary, then multiplying

(4.6) by u_x , integrating with respect to x , $-\infty < x < \infty$, we find

$$0 = \frac{1}{2} u_x^2 \Big|_{-\infty}^{\infty} + c_1 \int_{-\infty}^{\infty} u_x^2 dx - \int_0^1 f(u) du < - \int_0^1 f(u) du,$$

a contradiction.

EXAMPLE. Taking again the particular function $f(u) = u(1-u)(u-\alpha)$, $0 < \alpha < \frac{1}{2}$, we can actually calculate the numbers c_0, \bar{c}_0, c_1 . For it we need the results of Subsection 2.5. If we make the transformation $u = (1-\alpha)v + \alpha$, then v satisfies $(1-\alpha)v_{xx} + (1-\alpha)c v_x + \alpha(1-\alpha)^2 v(1-v)(1 + \frac{1-\alpha}{\alpha}v) = 0$. Let $x' = \sqrt{\alpha(1-\alpha)}x$ and $c' = \frac{c}{\sqrt{\alpha(1-\alpha)}}$, then we arrive at an equation with a source term of the form given in Theorem 2.13 ($v = \frac{1-\alpha}{\alpha}$). Using this theorem we find

$$c_0 = \sqrt{\alpha(1-\alpha)} c'_0 = \begin{cases} 2\sqrt{\alpha(1-\alpha)}, & \frac{1}{3} \leq \alpha < \frac{1}{2} \quad (1 < v \leq 2), \\ \sqrt{\alpha(1-\alpha)} \frac{v+2}{\sqrt{2v}} = \frac{1+\alpha}{\sqrt{2}}, & 0 < \alpha \leq \frac{1}{3} \quad (v \geq 2). \end{cases}$$

Next, if we make the transformation $u = \alpha(1-v)$, then v satisfies $-\alpha v_{xx} - \alpha c v_x - \alpha^2(1-\alpha)v(1-v)(1 + \frac{\alpha}{\alpha-1}v) = 0$. Let $x' = \sqrt{\alpha(1-\alpha)}x$, and $c' = \frac{c}{\sqrt{\alpha(1-\alpha)}}$, then again we arrive at the form as in Theorem 2.13 ($v = \frac{\alpha}{\alpha-1}$), thus

$$\bar{c}_0 = \sqrt{\alpha(1-\alpha)} c'_0 = 2\sqrt{\alpha(1-\alpha)}, \quad 0 < \alpha < \frac{1}{2} \quad (-1 < v < 0).$$

Finally we calculate c_1 . We know that the function

$$v(x) = [1 + \exp(\sqrt{v/2} x)]^{-1}$$

satisfies

$$v_{xx} + c_H v_x + v(1-v)(1+v) = 0,$$

with the speed $c_H = (v+2)/\sqrt{2v}$. This function is real only for $v > 0$. Consider negative values of v , and make the transformation $y = -i\sqrt{-v}x$, then one finds

$$v_{yy} - i c_H \sqrt{-v} v_y + v(1-v)(v^{-1}+v) = 0$$

or with $\alpha = -v^{-1} > 0$,

$$v_{YY} - ic_H \sqrt{\alpha} v_Y + v(1-v)(v-\alpha) = 0.$$

Thus

$$c_1 = -iv\sqrt{\alpha} c_H = -iv\sqrt{\alpha} \frac{v+2}{i\sqrt{2}\sqrt{-v}} = \frac{1}{\sqrt{2}} - \alpha\sqrt{2}.$$

We can summarize these results in the following diagram (Fig.15). Note that $2\sqrt{f'(\alpha)} = 2\sqrt{\alpha(1-\alpha)}$.

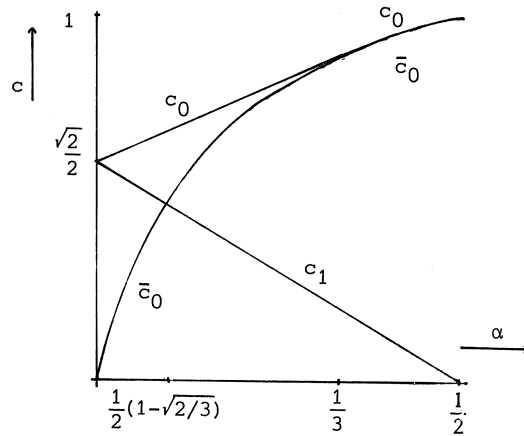

Figure 15

For other c -values there are non-monotonely fronts going to $(\alpha, 0)$ from $(1, 0)$ and $(0, 0)$, but we will not occupy ourselves here with the specific behaviour of these fronts (see HADELER & ROTHE [8]).

Now having established the existence of the front with speed c_1 , which we call $\phi_{c_1}(x)$, we can formulate analogues of Theorem 3.5 and 3.7.

THEOREM 4.7. *Let $u(x, t)$ be a solution of (4.1), (4.2) with $u(\cdot, 0) \in X$. If for some x_0 , $u(x, 0) = 0$ in (x_0, ∞) , then for each ξ and each $c > c_1$*

$$\lim_{t \rightarrow \infty} u(\xi + ct, t) = 0.$$

PROOF. From Theorem 4.5 we know that for $c > c_1$ the stable manifold S_c of $(0, 0)$ does not lie in the domain B , formed by the u -axis and the arc $v = u_x$ representing S_{c_1} . S_c cannot tend to minus infinity in

$$R = \{(u,v) \mid 0 < u < 1, v < 0\}$$

so S_c has to cross the boundary of R somewhere. We examine the following possibilities:

- (i) S_c cannot cross $u = 0, v < 0$, since the vector field $(v, -cv - f(u)) = (v, -cv)$ is pointing outward R ,
- (ii) S_c cannot cross the arc, representing S_{c_1} , connecting $(1,0)$ with $(0,0)$, hence S_c cannot cross $v = 0, 0 < u < 1$,
- (iii) $(1,0)$ is a saddle and the unique unstable manifold from $(1,0)$ is contained in B (see Theorem 4.5), while S_c is not. So S_c cannot start in $(1,0)$.

Hence S_c enters R through the line $u = 1, v < 0$. Let $q_c(x)$ denote the solution of (4.6), which corresponds to S_c , and for which $q_c(0) = 1$, then q_c is decreasing and approaches zero for $x \rightarrow \infty$. Reasoning as in Theorem 3.5 we have to prove $\tau(x) \equiv 0$, where $\tau(x)$ satisfies (4.6) and $\tau(x)$ is maximal with respect to the properties

$$\tau(x) \leq 1, \quad -\infty < x < \infty, \quad \tau(x) \leq q_c(x-x_0), \quad x_0 < x < \infty.$$

Let T denote the trajectory corresponding to τ . Then T has to enter $(0,0)$; the only possibility is along the stable manifold S_c but this is excluded since then there would exist an x , with $\tau(x) > 1$. So $\tau(x) \equiv 0$ only satisfies the requirements. \square

THEOREM 4.8. *Let $u(x,t)$ be a solution of (4.1), (4.2) with $u(\cdot,0) \in X$. Suppose $\lim_{t \rightarrow \infty} u(x,t) = 1$, then for each c , $|c| < c_1$ and each ξ $\lim_{t \rightarrow \infty} u(\xi+ct,t) = 1$.*

PROOF. A sufficient condition such that $\lim_{t \rightarrow \infty} u(x,t) = 1$ has been given in Theorem 4.4. We can apply Theorem 3.3 if we are assured of the existence of a solution of (4.6), connecting in the phase plane the positive v -axis with the negative v -axis, through the strip $0 < u \leq 1$. We consider only positive c -values (for negative values we transform x to $-x$).

In all cases the unstable manifold from $(1,0)$ reaches the negative v -axis (see Theorem 4.5) and the stable manifold S_c of $(0,0)$ can arrive only in the domain B on the interval $0 \leq u \leq 1$, say in the point η . Regarding the unstable manifold U_c of $(0,0)$ it follows by the boundedness of the slope

$\frac{dv}{du} = -c - \frac{f(u)}{v}$, that U_c crosses the line $u = \alpha$, $v > 0$; by continuing U_c in $\alpha \leq u \leq 1$ where the slope is negative we notice that U_c crosses the u -axis, say in $u = \eta_1$ ($\alpha \leq \eta_1 < 1$; $\eta_1 \neq 1$ by a reasoning like in Remark 4.6 ($c > 0$)). If $\eta > \eta_1$ S_c will cross the positive v -axis, lying above U_c in $0 < u < \eta_1$, and if $\eta_1 > \eta$ U_c will cross the negative v -axis, lying below S_c , $0 < u < \eta$. In view of Remark 2.1 we have established the existence of a trajectory \tilde{T}_c connecting the positive v -axis with the negative v -axis (see Fig.16).

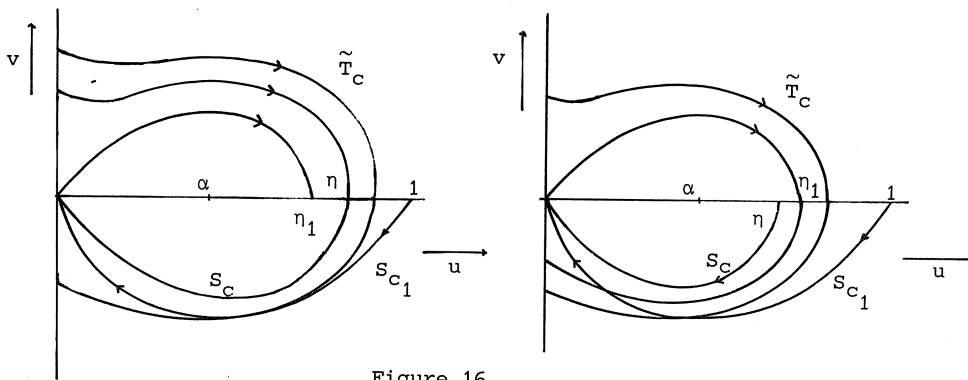

Figure 16

Again reasoning as in Remark 4.6, the possibility $\eta = \eta_1$ is excluded. Now the proof of Theorem 3.7 applies to give the desired result. \square

We will give more information about the manner of convergence to the state $u \equiv 1$. It turns out that under appropriate mild conditions on the initial function $\psi(x)$, $u(x,t)$ converges uniformly in x to some travelling front solution, with the unique speed c_1 , and with the translation of the argument determined by ψ .

THEOREM 4.9. (FIFE & McLEOD [6], [16]) *Let $u(x,t)$ be a solution of (4.1), (4.2) with $u(\cdot, 0) \in X$. Let $\phi(\xi)$ denote the travelling front, satisfying $\phi_{\xi\xi} + c_1 \phi_{\xi} + f(\phi) = 0$, $\phi(-\infty) = 1$, $\phi(\infty) = 0$, $\xi = x - c_1 t$. Let $u(x, 0) = \psi(x)$ satisfy*

$$(4.8) \quad \liminf_{x \rightarrow -\infty} \psi(x) > \alpha, \quad \limsup_{x \rightarrow \infty} \psi(x) < \alpha,$$

then there exists some x_0 such that

$$(4.9) \quad \lim_{t \rightarrow \infty} |u(x,t) - \phi(x - c_1 t - x_0)| = 0, \text{ uniformly in } x.$$

The proof of this theorem requires several lemmas.

LEMMA 4.10. For $\delta \leq \phi \leq 1 - \delta$, $\delta > 0$, it follows that $\phi_\xi(\xi) \leq -\beta$ for some constant $\beta > 0$.

PROOF. We have to show that $\phi_\xi(\xi)$ is bounded away from zero for values of ϕ in the given interval. If this does not hold then $\phi_\xi(\xi_0) = 0$ for some ξ_0 . Assume ϕ is increasing on an interval, which we take maximal, say (ξ_0, ξ_1) , $\phi_\xi(\xi_1) = 0$, $\phi_{\xi\xi}(\xi_0) \geq 0$, $\phi_{\xi\xi}(\xi_1) \leq 0$ and so using the differential equation $f(\phi(\xi_0)) \leq 0$, $f(\phi(\xi_1)) \geq 0$. Let ϕ_i denote $\phi(\xi_i)$, $i = 0, 1$ then

$$(4.10) \quad \phi_0 < \alpha < \phi_1.$$

Multiplying the differential equation for $\phi(\xi)$ by ϕ_ξ and integrating with respect to ξ from $-\infty$ to ξ_0 , we obtain

$$c_1 \int_{-\infty}^{\xi_0} \phi_\xi^2(\xi) d\xi = \int_{\phi_0}^1 f(u) du \equiv I_{\phi_0}^1.$$

Changing the boundaries we get in an analogous way

$$(4.11) \quad \text{sign } c = \text{sign } I_{\phi_0}^1 = \text{sign } I_{\phi_1}^{\phi_0} = \text{sign } I_0^{\phi_1}.$$

But (4.2), (4.10) gives $I_0^{\phi_1} < -I_{\phi_1}^{\phi_0} < I_{\phi_0}^1$, a contradiction with (4.11). The case $\xi_1 = \xi_0$, $\phi_\xi(\xi_0) = 0$, $\phi_{\xi\xi}(\xi_0) \neq 0$ gives $\phi_0 = \alpha$, and $\text{sign } c = \text{sign } I_0^\alpha = \text{sign } I_\alpha^1$, a contradiction as well. \square

We will use this lemma for the following basic lemma, where we construct suitable upper and lower solutions of $u(x,t)$.

LEMMA 4.11. Under the assumptions of Theorem 4.9, there exist constants $\xi_1, \xi_2, q_0 > 0, \mu > 0$ such that

$$(4.12) \quad \phi(\xi - \xi_1) - q_0 e^{-\mu t} \leq w(\xi, t) \leq \phi(\xi - \xi_2) + q_0 e^{-\mu t}$$

where $w(\xi, t)$ satisfies (4.5).

PROOF. We prove the left inequality. Let N be defined by

$$(4.13) \quad N[w] \equiv w_t - w_{\xi\xi} - c_1 w_\xi - f(w), \quad -\infty < \xi < \infty.$$

We require $N[w] = 0$, $w(\xi, 0) = \psi(\xi)$. We will construct functions $s(t)$, $q(t)$ such that $q(t) > 0$ and

$$\underline{w}(\xi, t) \equiv \max \{0, \phi(\xi - s(t)) - q(t)\}$$

will be a lower solution. First, let $q_0 > 0$ be any number such that $\alpha < 1 - q_0 < \liminf_{\xi \rightarrow -\infty} \psi(\xi)$, then take $\bar{\xi}$ such that

$$(4.14) \quad \phi(\xi - \bar{\xi}) - q_0 \leq \psi(\xi), \quad \text{for all } \xi.$$

This is possible for sufficiently large negative $\bar{\xi}$ by (4.8). Let

$$\Phi(u, q) = \begin{cases} (f(u-q) - f(u))/q & q > 0 \\ -f'(u) & q = 0. \end{cases}$$

Φ is continuous for $q \geq 0$. For $0 < q \leq q_0$ we have $\alpha < 1 - q_0 < 1 - q < 1$ hence $\Phi(1, q) > 0$. Also $\Phi(1, 0) = -f'(1) > 0$, thus for some $\mu > 0$ we have $\Phi(1, q) \geq 2\mu$, $0 < q < q_0$. By continuity, there exists a $\delta > 0$, such that $\Phi(u, q) \geq \mu$ for $1 - \delta < u < 1$, $0 \leq q \leq q_0$. In this range we have $f(u-q) - f(u) \geq \mu q$. Setting $\zeta = \xi - s(t)$ and using $\phi_{\xi\xi} + c_1 \phi_\xi + f(\phi) = 0$, we find

$$\begin{aligned} N[w] &= -s'(t) \phi_\zeta(\zeta) - c_1 \phi_\zeta(\zeta) - q'(t) - \phi_{\zeta\zeta}(\zeta) - f(\phi - q) = \\ &= -s'(t) \phi_\zeta(\zeta) - q'(t) + f(\phi) - f(\phi - q). \end{aligned}$$

If $\phi \in [1 - \delta, 1]$, $q \in [0, q_0]$ then

$$N[w] \leq -s'(t) \phi_\zeta(\zeta) - q'(t) - \mu q(t) \leq -(q'(t) + \mu q(t)),$$

provided $s'(t) \leq 0$, and since $\phi_\zeta(\zeta) \leq 0$ (see Lemma 4.10). We choose $q(t) = q_0 e^{-\mu t}$, which results in $N[\underline{w}] \leq 0$, if $1 - \delta \leq \phi \leq 1$. In the same way we get this result for $q < \phi \leq \delta$, by possibly further reducing μ and δ . For values $\delta \leq \phi \leq 1 - \delta$, we know by Lemma 4.10 that $\phi_\zeta(\zeta) \leq -\beta$, for some $\beta > 0$.

By the differentiability of f , we have $f(\phi) - f(\phi-q) \leq Kq$, for some $K > 0$, thus

$$N[w] \leq \beta s'(t) - q'(t) + Kq(t).$$

We set $s'(t) = \beta^{-1}[q'(t) - Kq(t)] = -\beta^{-1}(\mu+K)q(t) < 0$, with $s(0) = \bar{\xi}$. Specifically

$$(4.15) \quad s(t) = \bar{\xi} + \frac{q_0(\mu+K)}{\mu\beta}(-1+e^{-\mu t}).$$

Thus for $t \rightarrow \infty$, $s(t)$ approaches a finite limit $\xi_1 = \bar{\xi} - q_0(\mu+K)/\mu\beta$. Therefore $N[w] \leq 0$, whenever $w > 0$, and by condition (4.14) on $\bar{\xi}$ \underline{w} will be a lower solution. Therefore by Corollary 3.2

$$(4.16) \quad w(\xi, t) \geq \underline{w}(\xi, t) \geq \phi(\xi-s(t)) - q(t) \geq \phi(\xi-\xi_1) - q_0 e^{-\mu t},$$

i.e. the left hand part of (4.12). \square

LEMMA 4.12. *There exists a function $\omega(\epsilon)$, defined for small $\epsilon > 0$, such that $\lim_{\epsilon \rightarrow 0} \omega(\epsilon) = 0$ and if $0 \leq \psi(\xi) \leq 1$ and $|\psi(\xi) - \phi(\xi-\xi_0)| < \epsilon$ for some ξ_0 , then*

$$(4.17) \quad |w(\xi, t) - \phi(\xi-\xi_0)| < \omega(\epsilon) \quad -\infty < \xi < \infty, t > 0.$$

PROOF. We take q_0 as in Lemma 4.11, $q_0 = 0(\epsilon)$ and $|\xi_0 - \bar{\xi}| = 0(\epsilon)$. Since $\xi_1 = \bar{\xi} - \frac{q_0(\mu+K)}{\mu\beta}$, also $|\xi_0 - \xi_1| = 0(\epsilon)$ and analogous $|\xi_0 - \xi_2| = 0(\epsilon)$. Then (4.17) follows from Lemma 4.11 and from the uniform continuity of $\phi(\xi)$, $-\infty < \xi < \infty$. \square

DEFINITION 4.13. A function $w(\xi, t)$ defined for all ξ , and for $t > 0$, is said to have Property A if the derivatives listed below exist and are continuous, if $0 \leq w \leq 1$, and if for $k = 0, 1, 2, 3$

$$(4.18) \quad |\partial_{\xi}^k(1-w)|, |\partial_t w|, |\partial_{\xi} \partial_t w|, |\partial_t \partial_{\xi} w| < M_0(e^{\sigma_0 \xi} + e^{-\mu t}), \xi < 0$$

$$(4.19) \quad |\partial_{\xi}^k w|, |\partial_t w|, |\partial_{\xi} \partial_t w|, |\partial_t \partial_{\xi} w| < M_0(e^{-\sigma_1 \xi} + e^{-\mu t}), \xi > 0$$

where $M_0, \mu, \sigma_0, \sigma_1$ are positive numbers satisfying

$$(4.20) \quad 0 < \sigma_0 < \{-c_1 + \sqrt{c_1^2 - 4f'(1)}\}/2 = s_0,$$

$$(4.21) \quad 0 < \sigma_1 < \{c_1 + \sqrt{c_1^2 - 4f'(0)}\}/2 = s_1.$$

Note that s_0 is the direction of the unstable manifold at $(1,0)$, while $-s_1$ is the direction of the stable manifold at $(0,0)$ in the phase plane.

DEFINITION 4.14. A function $w(\xi, t)$ defined for all ξ , and for $t > 0$, is said to have Property B if it has Property A, with the term $e^{-\mu t}$ missing in (4.18), (4.19).

LEMMA 4.15. *The solution $w(\xi, t)$ of (4.5) has Property A. If $\psi(\xi)$ has Property B, then also $w(\xi, t)$ has Property B, with M_0, σ_0, σ_1 independent of t .*

PROOF. As in Section 3 we know that the derivatives are uniformly bounded by some constant M_1 . We derive (4.19) for $w_\xi = p(\xi, t)$. This function satisfies $L[p] = 0$, where $L[p]$ is defined by

$$L[p] \equiv pt - c_1 p_\xi - p_{\xi\xi} + \rho(\xi, t), \quad \rho(\xi, t) = -f'(w(\xi, t)).$$

There is a positive function $\omega(\delta)$ defined for small $\delta > 0$, such that $\lim_{\delta \rightarrow 0} \omega(\delta) = 0$ and $\rho > -f'(0) - \omega(\delta)$, whenever $|w| < \delta$. Let $f(\xi, t) = M \left(e^{-\sigma_1 \xi + e^{-(\sigma_1^2 - c_1 \sigma_1) t}} \right)$; for $|w| < \delta$ we have

$$(4.22) \quad L[\bar{p}] = (-\sigma_1^2 + c_1 \sigma_1 + \rho) \bar{p} > 0, \quad \text{if } \sigma_1^2 - c_1 \sigma_1 + f'(0) + \omega < 0,$$

By examining $g(s) = s^2 - c_1 s + f'(0)$, $g(s_1) = 0$, $g'(s_1) > 0$, we find (4.22) choosing $s_1 - \epsilon < \sigma_1 < s_1$, ϵ, ω small enough. Next we choose S and T so large, that by Lemma 4.11, $0 < w(\xi, t) < \delta$, $\xi > S$, $t > T$. Let Q be a quarterplane $Q = \{(\xi, t) \mid \xi > S, t > T\}$, then we have by (4.22) $L[\bar{p}] > 0$ in Q . Now we choose M so large that $\bar{p}(\xi, t) \geq M_1 > |p|$ for $(\xi, t) \in \{(\xi, t) \mid \xi > 0, t > 0\} \setminus Q$. This inequality holds on the boundary, so by Theorem 3.1 $p(\xi, t) \leq \bar{p}(\xi, t)$ in Q . In the same way $-p(\xi, t) \leq \bar{p}(\xi, t)$, so $|p(\xi, t)| = |\partial_\xi w(\xi, t)| < \bar{p}(\xi, t)$ in Q and hence for all $\xi > 0$, $t > 0$. Next we derive (4.19) for $w_{\xi\xi} = r(\xi, t)$. This function satisfies

$$(4.23) \quad L[r] = -\rho_\xi(\xi, t)p(\xi, t).$$

Let $\bar{r}(\xi, t) = M_2 \left(e^{-\bar{\sigma}_1 \xi + e^{-(\bar{\sigma}_1^2 - c_1 \bar{\sigma}_1) t}} \right)$. We wish to choose $M_2, \bar{\sigma}_1$ so that $L[\bar{r}] + \rho_{\xi} p > 0$ in a quarterplane. Since by the result above $|\rho_{\xi} p| < M_3 \left(e^{-\sigma_1 \xi + e^{-(\sigma_1^2 - c_1 \sigma_1) t}} \right)$ and $L[\bar{r}] = (-\bar{\sigma}_1^2 + c_1 \bar{\sigma}_1 + \rho) \bar{r}$, we can satisfy the desired inequality for large ξ and t , if $\bar{\sigma}_1 < \sigma_1, \bar{\sigma}_1^2 - c_1 \bar{\sigma}_1 < \sigma_1^2 - c_1 \sigma_1$, and $-\bar{\sigma}_1^2 + c_1 \bar{\sigma}_1 + \rho > 0$. Take $0 < \bar{\sigma}_1 < \sigma_1 < s_1$ and then δ so small that $g(\bar{\sigma}_1) + \omega(\delta) < 0$. So again $L[\bar{r}] + \rho_{\xi} p > 0$ in a quarterplane. Take M_2 large enough, then \bar{r} will be an upper solution, so $r < \bar{r}$ for that quarterplane. By enlarging M_2 we arrive at $r(\xi, t) < \bar{r}(\xi, t), \xi > 0, t > 0$ and in the same way $-r < \bar{r}$. Thus (4.19) is proved. All the other assertions follow in the same way. The second part of the lemma follows by taking time-independent comparison functions, and now Q can be extended down to $t = 0$. \square

LEMMA 4.16. *For each $\delta > 0$ the set functions $\{w(\cdot, t) \mid t \geq \delta\}$ considered as subset of $C^3(-\infty, \infty)$ is relatively compact.*

PROOF. As before we know that $w_{\xi}, w_{\xi\xi}, w_{\xi\xi\xi}$ are bounded and equicontinuous for $t \geq \delta$ (see section 3). Let $\{t_n\}$ be a given sequence. If there is a finite accumulation point t_{∞} then the uniform continuity of w and its derivatives on $[\delta, t_{\infty})$ implies that $w(\cdot, t)$ approaches a limit for a subsequence of $\{t_n\}$. So assume there is no finite accumulation point. For any $K > 0$, let $w_K(\xi, t)$ be the restriction of w to the set $|\xi| < K, t \geq \delta$. By the theorem of Arzela-Ascoli for each $K = 1, 2, \dots$ there is a subsequence $\{t_{n,K}\}$ such that the sequence $\{w_K(t_{n,K})\}$ converges in $C^3(-K, K)$. We can always restrict $\{t_{n,K+1}\}$ to be a proper subsequence of $\{t_{n,K}\}$. Take now a diagonal sequence, denoted by $\{t_n\}$, so $\{w(\xi, t_n)\}$ converges uniformly on each interval $[-K, K]$ to a limit $\tau(\xi)$, the derivatives up to order three converge to those of $\tau(\xi)$. Since w has Property A, we find that τ has Property B, and it satisfies also inequality (4.12) for $t = \infty$. Given any $\varepsilon > 0$, one may choose then T and K such that

$$|\partial_{\xi}^k (w(\xi, t) - \tau(\xi))| < \varepsilon, \quad |\xi| > K, t > T, \quad k = 0, 1, 2, 3,$$

and for N such that $t_N > T$

$$|\partial_{\xi}^k (w(\xi, t_n) - \tau(\xi))| < \varepsilon, \quad |\xi| < K, n > N,$$

so we have $\lim_{n \rightarrow \infty} w(\xi, t_n) = \tau(\xi)$ in $C^3(-\infty, \infty)$. \square

LEMMA 4.17. Suppose $\psi(\xi)$ has Property B, and that for some $\xi_1, \xi_2, \xi_2 > \xi_1$

$$(4.24) \quad \phi(\xi - \xi_1) \leq \psi(\xi) \leq \phi(\xi - \xi_2)$$

then there exists a ξ_3 , with $\xi_1 \leq \xi_3 \leq \xi_2$ and a subsequence $\{t_n\}$, $t_n \rightarrow \infty$, $n \rightarrow \infty$, such that

$$\lim_{n \rightarrow \infty} |\partial_\xi^k (w(\xi, t_n) - \phi(\xi - \xi_3))| = 0, \text{ uniformly in } \xi, k = 0, 1, 2, 3.$$

PROOF. From (4.24) it follows by the maximum principle that $\phi(\xi - \xi_1) \leq w(\xi, t) \leq \phi(\xi - \xi_2)$, $-\infty < \xi < \infty$, $t \geq 0$. We study the integral

$$\int_0^\infty e^{c_1 \xi} w^2(\xi, t) d\xi.$$

We know that $\phi(\xi) \sim e^{-s_1 \xi}$, $\xi \rightarrow \infty$ (see (4.21)), so $w^2(\xi, t) < Ce^{-2s_1 \xi}$ and $e^{c_1 \xi} w^2(\xi, t) < Ce^{-\delta \xi}$, $\xi \rightarrow \infty$, $\delta > 0$. So the integral converges. In the same way the following integrals converge (because $\psi(\xi)$ has Property B, so does $w(\xi, t)$ by Lemma 4.15)

$$\begin{aligned} \int_{-\infty}^0 e^{c_1 \xi} (1-w)^2 d\xi, & \quad \int_{-\infty}^\infty e^{c_1 \xi} w_\xi^2 d\xi, & \quad \int_{-\infty}^\infty e^{c_1 \xi} w_{\xi\xi}^2 d\xi, \\ \int_{-\infty}^\infty e^{c_1 \xi} w_t^2 d\xi, & \quad \int_{-\infty}^\infty e^{c_1 \xi} w_{t\xi} w_\xi d\xi. \end{aligned}$$

In view of the equation (4.5) the following integrals converge as well

$$\begin{aligned} (\text{recall } F(w) = \int_0^w f(u) du), \\ \int_0^\infty e^{c_1 \xi} F(w(\xi)) d\xi, & \quad \int_{-\infty}^0 e^{c_1 \xi} (F(w(\xi)) - F(1)) d\xi, \\ \int_{-\infty}^\infty e^{c_1 \xi} (F(w(\xi)) - H(-\xi)F(1)) d\xi, \end{aligned}$$

with $H(\xi) = 1$, $\xi > 0$, $H(\xi) = 0$, $\xi < 0$. Define the functional V by

$$V[w] \equiv \int_{-\infty}^\infty e^{c_1 \xi} [\frac{1}{2} w_\xi^2 - F(w(\xi)) + H(-\xi)F(1)] d\xi.$$

From this we deduce

$$\begin{aligned} \frac{d}{dt} V[w(\cdot, t)] &= - \int_{-\infty}^{\infty} e^{c_1 \xi} w_t [w_{\xi\xi} + c_1 w_{\xi} + f(w)] d\xi = \\ &- \int_{-\infty}^{\infty} e^{c_1 \xi} [w_{\xi\xi} + c_1 w_{\xi} + f(w)]^2 d\xi \leq 0 \end{aligned}$$

and it follows that V is a strict Lyapunov functional (see Chapter V). Since $V[w(\cdot, t)]$ is bounded, independently of t , and $\frac{d}{dt} V[w(\cdot, t)] \leq 0$ we have

$$(4.25) \quad \lim_{t \rightarrow \infty} \frac{d}{dt} V[w(\cdot, t)] = 0.$$

By Lemma 4.16 there exists a sequence $\{t_n\}$ such that $w(\xi, t_n)$ converges as $n \rightarrow \infty$ in C^3 to some limit $\tau(\xi)$. This, together with the exponential decay of the integrand of the Lyapunov functional, $\xi \rightarrow \pm \infty$, implies

$$\frac{d}{dt} V[w(\cdot, t_n)] \xrightarrow{n \rightarrow \infty} \frac{d}{dt} V[\tau(\cdot)] = - \int_{-\infty}^{\infty} e^{c_1 \xi} [\tau_{\xi\xi} + c_1 \tau_{\xi} + f(\tau)]^2 d\xi.$$

But, by (4.25) this integral is zero, so

$$(4.26) \quad \tau_{\xi\xi} + c_1 \tau_{\xi} + f(\tau) = 0.$$

Further we know by (4.12) $\tau(-\infty) = 1$, $\tau(\infty) = 0$, so by Theorem 4.5 we find $\tau(\xi) = \phi(\xi - \xi_3)$ for some ξ_3 . \square

Now we are ready to give the

PROOF OF THEOREM 4.9.

We have found in the proof of Lemma 4.16 that there exists a function $\sigma(\xi)$, which satisfies (4.12), with $t = \infty$, so $\sigma(\xi)$ satisfies the hypothesis of Lemma 4.17, i.e., (4.24). Let $v(\xi, t)$ be the solution of

$$(4.27) \quad v_t - v_{\xi\xi} - c_1 v_{\xi} - f(v) = 0, \quad v(\xi, \bar{t}) = \sigma(\xi),$$

\bar{t} arbitrary, then by Lemma 4.17 there is a front $\phi(\xi - \xi_0)$ in the limit set of v . Use Lemma 4.12 to show that $\lim_{t \rightarrow \infty} v(\xi, t) = \phi(\xi - \xi_0)$. Next we note that solutions of (4.1), (4.2) are continuous with respect to their initial data in $C^0(-\infty, \infty)$, thus there exists a function $K(t)$, independent of $\psi(\xi)$, such that if w_i , $i = 1, 2$ are solutions of (4.5), with initial data ψ_i , $0 \leq \psi_i \leq 1$, then

$$\sup_{-\infty < \xi < \infty} |w_1(\xi, t) - w_2(\xi, t)| \leq K(t) \sup_{-\infty < \xi < \infty} |\psi_1(\xi) - \psi_2(\xi)|,$$

(this can be proved by formula (3.3)). Now we know that for fixed $\varepsilon > 0$ and \tilde{t} , we can choose N such that for $n > N$ $|w(\xi, t_n) - \sigma(\xi)| < \varepsilon/2K(\tilde{t})$.

Further in view of the convergence of v to a front, there is a \tilde{t} , such that for $t \geq \tilde{t}$ $|v(\xi, t_n + t) - \phi(\xi - \xi_0)| < \varepsilon/2$ (we have chosen $\tilde{t} = t_n$ in (4.27)).

Now it follows that

$$\begin{aligned} |w(\xi, t_n + \tilde{t}) - v(\xi, t_n + \tilde{t})| &\leq K(\tilde{t}) |w(\xi, t_n) - \sigma(\xi)| < \varepsilon/2, \\ |w(\xi, t_n + \tilde{t}) - \phi(\xi - \xi_0)| &< |w(\xi, t_n + \tilde{t}) - v(\xi, t_n + \tilde{t})| + \\ |v(\xi, t_n + \tilde{t}) - \phi(\xi - \xi_0)| &< \frac{\varepsilon}{2} + \frac{\varepsilon}{2} = \varepsilon, \quad n > N, \text{ uniformly in } \xi, \end{aligned}$$

so in the limit set of w there is a front $\phi(\xi - \xi_0)$. By Lemma 4.12 again we find for all t , $t > T$

$$|w(\xi, t + \tilde{t}) - \phi(\xi - \xi_0)| < \omega(\varepsilon), \text{ with } \lim_{\varepsilon \downarrow 0} \omega(\varepsilon) = 0,$$

so the assertion of the theorem is proved. \square

5. THE INITIAL-BOUNDARY VALUE PROBLEM

Since we expect that our equation describes to a certain extent the propagation of a voltage pulse through the nerve axon, it is appropriate to study the initial-boundary value problem (5.1) below, because axons are stimulated at one end. Interpreting (5.1) we may think of an axon extending over $0 \leq x < \infty$, where at $x = 0$ for some time a stimulus is given. It is to be expected that a stimulus of a low level, persisting during a short time, will die out, while a stimulus of a high level, persisting during a long time, will grow and will finally reach a maximum value (in our model $u = 1$), and will travel along the nerve. A good model for nerve propagation will exhibit the feature that the stimulus given at $x = 0$ influences the state of the axon at $x > 0$ but that after some time the rest state, $u \equiv 0$, is reached again. Our simple model does not have this property, and we refer to Chapter VII, where a short introduction will be given to the so-called Nagumo equation, which will exhibit this feature. The Nagumo equation can be derived from the famous Hodgkin-Huxley equation under certain limit processes and it will show qualitatively all the desired properties of a good nerve axon model.

We can interpret the equation of Sections 4,5 as a limit case of the Nagumo equation, corresponding to an axon that is treated with some toxin, such that the recovery-variable cannot act.

In mathematical terms we study the problem

$$\begin{aligned}
 &u_t = u_{xx} + f(u), \quad x > 0, \quad t > 0, \\
 (5.1) \quad &u(x,0) = 0, \quad x \geq 0, \\
 &u(0,t) = \chi(t), \quad 0 \leq \chi(t) \leq 1, \quad t \geq 0,
 \end{aligned}$$

where $f(u)$ has properties (4.2). We will give appropriate analogues of the theorems in the Sections 5 and 4.

THEOREM 5.1. (Compare Theorem 3.3) *Let $q \in X$ satisfy $q_{xx} + f(q) \geq 0$ in (a,b) where $0 < a < b \leq \infty$. Assume $q(a) = 0$, and if $b < \infty$, assume $q(b) = 0$. Let $u(x,t)$ denote the solution of*

$$\begin{aligned}
 &u_t = u_{xx} + f(u), \quad x > 0, \quad t > 0, \\
 (5.2) \quad &u(x,0) = \begin{cases} q(x) & \text{in } (a,b), \\ 0 & \text{in } \mathbb{R}^+ \setminus (a,b), \end{cases} \\
 &u(0,t) = \phi(t), \quad 0 \leq \phi(t) \leq 1, \quad t \geq 0.
 \end{aligned}$$

Suppose $\phi(t)$ is nondecreasing, $\phi(0) = 0$, then $u(x,t)$ is nondecreasing in t and $\lim_{t \rightarrow \infty} u(x,t) = \tau(x)$, uniformly in each bounded x -interval of \mathbb{R}^+ , where $\tau(x)$ is the smallest nonnegative solution of $\tau_{xx} + f(\tau) = 0$ in \mathbb{R}^+ , which satisfies the inequalities $\tau(0) \geq \lim_{t \rightarrow \infty} \phi(t)$ and $\tau(x) \geq q(x)$ in (a,b) , $0 \leq \tau(x) \leq 1$ for $x > 0$.

PROOF. From Corollary 3.2 it follows that $u(x,h) \geq u(x,0)$, $x \geq 0$, for all $h > 0$, and since the boundary condition $\phi(t)$ is nondecreasing, Corollary 3.2 gives also $u(x,t+h) \geq u(x,t)$ for all $h > 0$. Thus, for each x , $u(x,t)$ is nondecreasing in t and bounded above and so $\lim_{t \rightarrow \infty} u(x,t) = \tau(x)$ exists. To conclude that $\tau_{xx} + f(\tau) = 0$, it is sufficient to prove that u_x, u_{xx} and u_t are for $t \geq \delta > 0$ uniformly bounded and on $\{x \mid x \geq \epsilon > 0\}$ equicontinuous (ϵ, δ are arbitrary constants). We refer to FRIEDMAN [15, p.92, Theorem 1], from which this conclusion can be drawn. (Note that we can use the a priori estimate $u(\cdot, t) \in X$ successfully in a modification of the proof of the above mentioned theorem, which is stated for a linear parabolic differential equa-

tion $L[u] = f(x,t)$; show first that u_x , u_{xx} and u_t are uniformly bounded and use this knowledge in the a priori estimates for the given Hölder norms). By the Arzela-Ascoli Theorem we know that on each bounded x -interval the families u_x , u_{xx} and u_t , parametrized by t , are relatively compact, and since u converges to τ , u_x , u_{xx} and u_t converge to the corresponding derivatives, so $\tau_{xx} + f(\tau) = \tau_t = 0$. In the same way as in Theorem 3.3 $\tau(x)$ is the smallest solution such that $\tau(x) \geq q(x)$ in (a,b) and $\tau(\epsilon) \geq \lim_{t \rightarrow \infty} \phi(t)$, and since ϵ was arbitrary $\tau(0) = \lim_{\epsilon \rightarrow 0} \tau(\epsilon) \geq \lim_{t \rightarrow \infty} \phi(t)$. \square

As in Section 3 and 4, for the use of Theorem 5.1 we have to study the solutions $\tau(x)$ of $\tau_{xx} + f(\tau) = 0$, $0 \leq \tau \leq 1$, $x \geq x_0$, x_0 arbitrary. We find immediately the solution, representing the stable manifold to $(1,0)$ in the phase plane: $\theta(x)$, with $\theta(0) = 0$. Examine further the problem (5.3) below

$$(5.3) \quad \begin{aligned} q_{xx} + f(q) &= 0, & x > 0, & \quad q(0) = \beta, & \quad \frac{d}{dx} q(0) = 0, & \quad 0 \leq \beta \leq 1, \\ 0 \leq q(x) &\leq 1, & x \geq 0. \end{aligned}$$

Recalling (4.4) and using Subsection 4.1, we know that for $0 \leq \beta \leq \kappa$ $q(x) = q_\beta(x)$ is the solution of (5.3) in the notation of that subsection, while for $\kappa < \beta < 1$ the condition $0 \leq q(x) \leq 1$, $x \geq 0$ can not be fulfilled; $\beta = 1$ gives $q(x) \equiv 1$.

THEOREM 5.2. *Let $u(x,t)$ be a solution of (5.1) with f satisfying (4.2) and with $u(\cdot, t) \in X$ for all $t \geq 0$. If $\beta = \sup_{t \geq 0} \chi(t) < \kappa$ then $u(x,t) \leq q_\kappa(x+x_0)$ for $x_0 > 0$ with $q_\kappa(x_0) = \beta$. In particular $\lim_{x \rightarrow \infty} \limsup_{t \rightarrow \infty} u(x,t) = 0$.*

PROOF. For $\beta < \kappa$ we have seen that there is a periodic function q_β satisfying $q_{xx} + f(q) = 0$, $q(0) = \beta$. Let $v(x,t)$ denote the solution of (5.1) with the boundary condition $v(0,t) = \phi(t) = \sup_{t_1 < t} \chi(t_1)$; this function is nondecreasing, and satisfies $\lim_{t \rightarrow \infty} \phi(t) = \sup_{t \geq 0} \chi(t) = \beta < \kappa$. It follows that $u(x,t) \leq v(x,t)$. The limit solution $\tau(x) = \lim_{t \rightarrow \infty} v(x,t)$ is the minimal solution of $\tau_{xx} + f(\tau) = 0$ with the property $v(x,t) \leq \tau(x)$ for all $x > 0$, $t > 0$. Since we can take the interval (a,b) from Theorem 5.1 arbitrary, we can prove that for every possible solution $\tau(x) = q_\beta(x+x_0)$, $0 < \beta < \kappa$ there exists an interval (a,b) such that $q_\kappa(x+x_0) < q_\beta(x)$ in (a,b) . So necessarily $\tau(x) = q_\kappa(x+x_0)$ ($= \phi(x+x_0)$, see Subsection 4.1) with $x_0 > 0$ and $q_\kappa(x_0) = \beta$ and so $\lim_{t \rightarrow \infty} \sup u(x,t) \leq q_\kappa(x+x_0)$, thus $\lim_{x \rightarrow \infty} \limsup_{t \rightarrow \infty} u(x,t) \leq \lim_{x \rightarrow \infty} q_\kappa(x+x_0) = 0$. \square

As was mentioned above we have shown with this theorem a kind of threshold relation. In the following theorem we will formulate a threshold relation which is more adapted to physical situations; it turns out that an appropriate measure of the strength of the pulse at $x = 0$ can be given in the form of an integral.

THEOREM 5.3. (Compare Theorem 4.2) *Let $u(x,t)$ be a solution of (5.1) with f satisfying (4.2) and with $u(\cdot, t) \in X$ for all $t \geq 0$. Suppose that for some $T > 0$ and some $\rho \in (0, \alpha)$*

$$(5.4) \quad \chi(t) \leq \rho, \quad t > T$$

and

$$(5.5) \quad \int_0^T e^{s(T-t)} [\chi(t) - \rho]^+ dt < \sqrt{\frac{2\pi}{e}} \frac{(\alpha - \rho)}{s}$$

where $s = s(\rho)$ and $[\cdot]^+$ are defined as in Theorem 4.2, then

$$\lim_{x \rightarrow \infty} \limsup_{t \rightarrow \infty} u(x,t) = 0.$$

PROOF. The proof follows the same lines as the proof of Theorem 4.2: $v(x,t) = u(x,t) - \rho$; $w(x,t)$ is the solution of $w_t = w_{xx} + sw$, $w(x,0) = [u(x,0) - \rho]^+ = 0$, $w(0,t) = [\chi(t) - \rho]^+$ and $\bar{w} = w e^{-st}$ is the solution of $\bar{w}_t = \bar{w}_{xx}$, $\bar{w}(x,0) = 0$, $\bar{w}(0,t) = [\chi(t) - \rho]^+ e^{-st}$. In the same way it follows that $w(x,t) \geq u(x,t) - \rho$. We want to show for some $x_1 \sup_{t \geq 0} w(x_1, t) < \alpha - \rho$, since then $\sup_{t \geq 0} u(x_1, t) < \alpha < \kappa$ and we can apply Theorem 5.2. We use the explicit expression for $\bar{w}(x,t)$:

$$(5.6) \quad w(x,t) = \bar{w}(x,t) e^{st} = \frac{x}{2\sqrt{\pi}} \int_0^t e^{s(t-\tau)} [\chi(\tau) - \rho]^+ (t-\tau)^{-\frac{3}{2}} e^{-\frac{x^2}{4(t-\tau)}} d\tau.$$

We make the following assertions:

- (i) For $\delta > 0$ fixed, $w(x, T+\delta) < \alpha - \rho$, $x \geq 0$, so $u(x, T+\delta) < \alpha$, $x \geq 0$;
- (ii) $w(x,t) < \alpha - \rho$, $x \geq 0$, $t \geq T + \delta$, so $u(x,t) < \alpha$, $x \geq 0$, $t \geq T + \delta$;
- (iii) For x_1 large enough $w(x_1, t) < \alpha - \rho$, $0 \leq t \leq T + \delta$;
- (iv) $\sup_{t \geq 0} u(x_1, t) < \alpha < \kappa$.

For (i) we need a careful analysis, see below; Corollary 3.2 yields (ii); (iii) follows from the representation (5.6) and (iv) is a consequence of (ii), (iii) and Corollary 3.2.

PROOF OF (i). For $\tau > T$ the integrand in (5.6) gives no contribution in view of (5.4), so

$$w(x, T+\delta) = \frac{x}{2\sqrt{\pi}} e^{s\delta} \int_0^T e^{s(T-\tau)} [\chi(\tau) - \rho]^+_{(T+\delta-\tau)} e^{-\frac{3}{2} \frac{x^2}{4(T+\delta-\tau)}} d\tau \equiv I.$$

Consider $g(\beta) = 2\alpha^{\frac{1}{2}} \beta^{-\frac{3}{2}} e^{-\alpha/\beta}$, which is maximal for $\beta = \frac{2}{3}\alpha$ and $g(\frac{2}{3}\alpha) =$

$$= 3^{\frac{3}{2}} \frac{1}{2} \alpha^{-1} e^{-\frac{3}{2}}, \text{ and } h(\alpha) = 2\alpha^{\frac{1}{2}} \beta^{-\frac{3}{2}} e^{-\alpha/\beta}, \text{ which is maximal for}$$

$$\alpha = \frac{1}{2}\beta \text{ and } h(\frac{1}{2}\beta) = 2^{\frac{1}{2}} \beta^{-1} e^{-\frac{1}{2}}.$$

Let $\alpha = \frac{x^2}{4}$, $\beta(\tau) = T + \delta - \tau$, $0 \leq \tau \leq T$.

We distinguish the following three cases:

- (a) $\frac{3}{2}\beta(T) \leq \alpha \leq \frac{3}{2}\beta(0)$, then the maximum of the function $g(T+\delta-\tau)$ turns up in the interval of integration. So using $\alpha = \frac{x^2}{4}$, and thus $6\delta < x^2$, we have

$$g(\frac{2}{3}\alpha) = 6^{\frac{3}{2}} x^{-2} e^{-\frac{3}{2}} < 6^{\frac{1}{2}} \delta^{-1} e^{-\frac{3}{2}}$$

and consequently $I < \frac{e^{s\delta}}{2\sqrt{\pi}} \frac{\sqrt{6}}{\delta} e^{-\frac{3}{2}} \int_0^T e^{s(T-\tau)} [\chi(\tau) - \rho]^+ d\tau$.

- (b) $0 \leq \alpha \leq \frac{3}{2}\beta(T)$, then the maximum of g will be reached for $\tau = T$. So $\beta(T) = \delta$ and

$$g(\delta) = 2\alpha^{\frac{1}{2}} \delta^{-\frac{3}{2}} e^{-\alpha/\delta} = h(\alpha) < h(\frac{1}{2}\delta) = 2^{\frac{1}{2}} \delta^{-1} e^{-\frac{1}{2}}.$$

- (c) $\frac{3}{2}\beta(0) \leq \alpha$, then the maximum of g will be reached for $\tau = 0$. So $\beta(0) = T + \delta$ and

$$g(T+\delta) = 2\alpha^{\frac{1}{2}} (T+\delta)^{-\frac{3}{2}} e^{-\alpha/(T+\delta)} = h(\alpha) < h(\frac{1}{2}(T+\delta)) = 2^{\frac{1}{2}} (T+\delta)^{-1} e^{-\frac{1}{2}}.$$

From

$$\max\left\{\frac{\sqrt{6}}{\delta} e^{-\frac{3}{2}}, \frac{\sqrt{2}}{\delta} e^{-\frac{1}{2}}, \frac{\sqrt{2}}{T+\delta} e^{-\frac{1}{2}}\right\} = \frac{\sqrt{2}}{\delta} e^{-\frac{1}{2}},$$

and from (5.5) we deduce after substituting of $\delta = s^{-1}$

$$I < \frac{e^{s\delta}}{2\sqrt{\pi}} \frac{\sqrt{2}}{\delta} e^{-\frac{1}{2}} \frac{\sqrt{2\pi}}{e} \frac{(\alpha-\rho)}{s} = \alpha - \rho,$$

and finally $w(x, T+\delta) < \alpha - \rho$, $x \geq 0$. \square

PROOF OF (iii). By the representation (5.6) of $w(x, t)$ we can choose x_1 large enough, namely

$$\frac{x_1^2}{4} > \frac{3}{2}(T+\delta) > \frac{3}{2}t, \quad \text{for } 0 \leq t \leq T+\delta,$$

which gives

$$w(x_1, t) < \frac{x_1}{2\sqrt{\pi}} (T+\delta)^{-\frac{3}{2}} e^{-\frac{x_1^2}{4(T+\delta)}} \sqrt{\frac{2\pi}{e}} \frac{(\alpha-\rho)}{s}.$$

Choose now further $x_1 e^{-\frac{x_1^2}{4(T+\delta)}} < 2^{\frac{1}{2}}(T+\delta)^{\frac{3}{2}} s e^{\frac{1}{2}}$, which leads to $w(x_1, t) < \alpha - \rho$, $0 \leq t \leq T + \delta$. \square

THEOREM 5.4. (Compare Theorem 4.4) *Let $u(x, t)$ be a solution of (5.1) with f satisfying (4.2) and with $u(\cdot, t) \in X$ for all $t \geq 0$. For any $\beta \in (\kappa, 1)$ there is a positive time T_β with the property that the condition $\chi(t) \geq \beta$ on (t_0, t_0+T_β) , $t_0 \geq 0$ implies $\lim_{x \rightarrow \infty} \liminf_{t \rightarrow \infty} u(x, t) = 1$.*

PROOF. Let $\sigma(t)$ be a smooth nondecreasing function, satisfying $\sigma(t) = 0$ in $(-\infty, 0)$, $\sigma(t) = \beta$ in $(1, \infty)$. Let $w(x, t)$ denote the solution of the problem (5.1) where we have chosen $\chi(t) = \sigma(t)$. By Theorem 5.1 $\lim_{t \rightarrow \infty} w(x, t) = \tau(x)$, where $\tau(x)$ is the smallest nonnegative solution of the problem $\tau_{xx} + f(\tau) = 0$, $\tau(0) \geq \beta$, $\tau(x) \geq 0$ in $(0, \infty)$. Let $\theta(x)$, with $\theta(0) = 0$, represent the stable manifold to $(1, 0)$, then we know, in view of the remarks above, that $\tau(x) = \theta(x-x_1)$, where $x_1 < 0$ is such that $\theta(-x_1) = \beta$. Moreover we know that the convergence of $w(x, t)$ to $\theta(x-x_1)$ is uniform on each bounded interval. Thus $q_\beta(x-l_\beta-1) \leq \beta < \theta(x-x_1)$ on $(1, 1+2l_\beta)$. Since $w(x, t)$ converges to $\theta(x-x_1)$ uniformly on $[1, 1+2l_\beta]$ there is a time T_β for which $w(x, T_\beta) \geq q_\beta(x-l_\beta-1)$ on $[1, 1+2l_\beta]$. Further by Corollary 3.2 it follows from $\chi(t) \geq \beta \geq \sigma(t)$ on (t_0, t_0+T_β) and $u(x, t_0) \geq 0 = w(x, 0)$, $x \geq 0$: $u(x, t_0+t) \geq w(x, t)$, $x \geq 0$, $0 \leq t \leq T_\beta$, thus $u(x, t_0+T_\beta) \geq w(x, T_\beta) \geq q_\beta(x-l_\beta-1)$ on $(1, 1+2l_\beta)$. Again by Corollary 3.2 and Theorem 5.1 $\liminf_{t \rightarrow \infty} u(x, t)$ is bounded below by a nonnegative solution $\tau^*(x)$, $x \geq 0$ of $\tau_{xx} + f(\tau) = 0$, which in turn is bounded below by $q_\beta(x-l_\beta-1)$ on $(1, 1+2l_\beta)$. In particular $\tau^*(1+l_\beta) \geq q_\beta(0) = \beta > \kappa$. So it follows that $\tau^*(x) = \theta(x-x_2)$, $x_2 < 0$ thus $\lim_{x \rightarrow \infty} \liminf_{t \rightarrow \infty} u(x, t) = 1$. \square

This last theorem provides us with a kind of counterpart to Theorem 5.3: if the stimulus at the boundary will persist during a time, long enough above the level β , then the resulting signal will tend to one.

LITERATURE

- [1] FISHER, R.A., *The Genetical Theory of Natural Selection* (Oxford University Press, 1930).
- [2] FISHER, R.A., *The advance of advantageous genes*, Ann. Eugenics 7 (1937) 355-369.
- [3] KOLMOGOROFF, A., I. PETROVSKY & N. PISCOUNOFF, *Étude de l'équation de la diffusion avec croissance de la quantité de matière et son application à un problème biologique*, Bull. Univ. Moscou, Ser. Internat., Sec. A, 1 (1937), #6, 1-25.
- [4] SATTINGER, D.H., *On the stability of waves of nonlinear parabolic systems*, to appear.
- [5] ROTHE, F., *Über das asymptotische Verhalten der Lösungen einer nichtlinearen parabolischen Differentialgleichung aus der Populationsgenetik* (Thesis, Eberhard-Karls-Universität, Tübingen, 1975).
- [6] FIFE, P.C. & J.B. McLEOD, *The approach of solutions of nonlinear diffusion equations to travelling wave solutions*, Bull. Amer. Math. Soc. 81 (1975) 1076-1078.
- [7] KANEL', Ja. I., *Certain problems on equations in the theory of burning*, Dokl. Akad. Nauk SSSR 136 (1961) 277-280; Soviet Math. Dokl. 2, 48-51.
- [8] HADELER, K.P. & F. ROTHE, *Travelling fronts in nonlinear diffusion equations*, J. Math. Biol. 2 (1975) 251-263.
- [9] ARONSON, D.G. & H.F. WEINBERGER, *Nonlinear diffusion in population genetics, combustion, and nerve pulse propagation*, in: J.A. Goldstein, ed., *Partial Differential Equations and Related Topics*, Lecture Notes in Math. 446 (Springer, Berlin, 1975) 5-49
- [10] CODDINGTON, E.A. & N. LEVINSON, *Theory of Ordinary Differential Equations*, (McGraw-Hill, New York, 1955).

- [11] TEMME, N.M., ed., *Nonlinear Analysis, Vol. I*, MC Syllabus 26.1 (Mathematisch Centrum, Amsterdam, 1976).
- [12] ANDRONOV, A.A., E.A. LEONTOVICH, I.I. GORDON & A.G. MAIER, *Qualitative Theory of Second-order Dynamic Systems* (Wiley, New York, 1973).
- [13] HALE, J.K., *Ordinary Differential Equations* (Wiley, New York, 1969).
- [14] CHAFEE, N., *A stability analysis for a semilinear parabolic partial differential equation*, J. Differential Equations 15 (1974) 522-540.
- [15] FRIEDMAN, A., *Partial Differential Equations of Parabolic Type* (Prentice Hall, Englewood Cliffs, N.J., 1964).
- [16] FIFE P.C. & J.B. McLEOD, *The approach of solutions of nonlinear diffusion equations to travelling front solutions*, Arch. Rational Mech. Anal. 65 (1977) 335-361.

V. EXAMINATION OF STABILITY BY MEANS OF LYAPUNOV FUNCTIONS

1. INTRODUCTION

The present chapter again deals with the nonlinear parabolic initial boundary value problem in one x -variable, which was also considered in chapters I, II and III. Here, the technique of Lyapunov functions, already familiar from the theory of ordinary differential equations, will be illuminated. For a special equation a description was given in Chapter I of how the stability of equilibrium solutions can be examined in this way. Here, we first develop the theory in the abstract context of dynamical systems. In the application to parabolic equations we do not use the H^1 -topology, as in Chapter I, but only the C^0 -and C^1 -topology. In Chapter III, Section 5, it has already been pointed out that stability depends on the sign of the smallest eigenvalue of the linearized differential operator in x with suitable boundary values. In the case of one x -variable this eigenvalue problem is a regular Sturm-Liouville problem, for which there exists an extensive theory. We conclude this chapter by proving instability results for non-constant equilibrium solutions in the case of a source term depending on u but not on x . The philosophical implications of these results have already been mentioned in Chapter I, Section 3.

The present chapter is based on papers by PELETIER [1], CHAFEE & INFANTE [2], CHAFEE [3] and AUCHMUTY [4].

2. LYAPUNOV FUNCTIONS FOR ORDINARY DIFFERENTIAL EQUATIONS

Consider the initial value problem

$$(2.1) \quad \frac{du}{dt} = f(u),$$

$$(2.2) \quad u(0) = x,$$

where $f: \mathbb{R}^n \rightarrow \mathbb{R}^n$ is continuously differentiable and $x \in \mathbb{R}^n$. This problem is equivalent to the integral equation

$$(2.3) \quad u(t) = x + \int_0^t f(u(\tau)) d\tau.$$

It is well known (cf., for instance, HALE [5, Chap.I]) that the problem (2.1), (2.2) has at most one solution $u(t,x)$, and that $u(t,x)$ exists at a maximal open subset E of $\mathbb{R} \times \mathbb{R}^n$ which includes $\{0\} \times \mathbb{R}^n$. Furthermore, the mapping $u: E \rightarrow \mathbb{R}^n$ is continuous and $u(0,x) = x$, $u(t_1, u(t_2, x)) = u(t_1 + t_2, x)$, where the last identity holds as long as both sides are well-defined. If $[0, \infty) \times \mathbb{R}^n \subset E$, then the mapping u is an example of a dynamical system.

Let $x_0 \in \mathbb{R}^n$, $f(x_0) = 0$. Then the mapping $t \rightarrow x_0$ is an equilibrium solution of (2.1). Let

$$f'(y) := \begin{pmatrix} \frac{\partial f_1}{\partial y_j}(y) \end{pmatrix}$$

denote the Jacobian matrix of f . The stability of the equilibrium solution x_0 is related to the eigenvalues of $f'(x_0)$ in the following way. A necessary condition for stability of x_0 is that no eigenvalue of $f'(x_0)$ has positive real part; a sufficient condition is that all eigenvalues have negative real part (cf. CODDINGTON & LEVINSON [6, Ch.13, Section 1]).

The stability of equilibrium solutions of (2.1) can also be examined by means of Lyapunov functions. A function $V \in C^1(\mathbb{R}^n)$ is called a Lyapunov function for the differential equation (2.1) if $\frac{d}{dt}V(u(t)) \leq 0$ for each solution u of (2.1). If, moreover, this inequality is strict for all nonequilibrium solutions u of (2.1), then V is called a strict Lyapunov function. Let x_0 be an isolated equilibrium solution of (2.1) and let V be a strict Lyapunov function. Then a necessary condition for stability of x_0 is that V attains a local minimum in x_0 ; a sufficient condition is that V attains a strict local minimum in x_0 (cf. HALE [5, Section X.1]).

In general, it is difficult to find an explicit Lyapunov function for a given equation (2.1). However, if (2.1) is a gradient system, i.e. if

$$\frac{\partial f_i}{\partial y_j} = \frac{\partial f_j}{\partial y_i}, \quad i, j = 1, \dots, n,$$

then a Lyapunov function can be defined in a canonical way as follows. There exists $V \in C^2(\mathbb{R}^n)$, unique up to a constant term, such that $\text{grad } V = -f$. If u is a solution of (2.1), then

$$(2.4) \quad \frac{d}{dt}V(u(t)) = -\left|\frac{du(t)}{dt}\right|^2.$$

Hence V is a strict Lyapunov function. Furthermore, if x_0 is an equilibrium solution of (2.1), then

$$(2.5) \quad V(x_0+z) - V(x_0) = -\frac{1}{2} \sum_{i,j=1}^n \left[\frac{\partial f_i(y)}{\partial y_j} \right]_{y=x_0} z_i z_j + o(|z|^2)$$

for $z \rightarrow 0$. Thus, for gradient systems the connection between the stability of x_0 , the spectrum of $f'(x_0)$, and the behaviour of V around x_0 , is clear.

3. PRELIMINARIES ON NONLINEAR PARABOLIC INITIAL BOUNDARY VALUE PROBLEMS

Let f be a once continuously differentiable function on $[0, \pi] \times \mathbb{R}$ and let $0 < s \leq \infty$. Consider the parabolic initial boundary value problem

$$(3.1) \quad u_t(x,t) = u_{xx}(x,t) + f(x,u(x,t)), \quad 0 < x < \pi, \quad 0 < t < s,$$

where u satisfies either Dirichlet boundary conditions

$$(3.2) \quad u(0,t) = 0 = u(\pi,t), \quad 0 \leq t < s,$$

or Neumann boundary conditions

$$(3.3) \quad u_x(0,t) = 0 = u_x(\pi,t), \quad 0 < t < s,$$

and has initial value

$$(3.4) \quad u(x,0) = \phi(x), \quad 0 \leq x \leq \pi.$$

In (3.4) it is supposed that $\phi \in C([0, \pi])$ and, in case of Dirichlet boundary conditions for u , $\phi(0) = 0 = \phi(\pi)$.

The combination of Corollaries II.1.10 and II.1.11 and Theorems II.3.4 and II.3.5 yields

THEOREM 3.1. *Problem (3.1)-(3.4) has at most once classical solution u . For some $s > 0$ there exists a function u on $[0, \pi] \times [0, s)$ such that u , u_x , u_{xx} and u_t are continuous and (3.1), (3.4) and (3.2) or (3.3) are satisfied.*

Let us define B^0 as the class of all $\phi \in C([0, \pi])$ such that, in the case of boundary conditions (3.2), $\phi(0) = 0 = \phi(\pi)$. Let B^1 be the class of all $\phi \in C^1([0, \pi])$ such that $\phi(0) = 0 = \phi(\pi)$ in the case of boundary conditions (3.2), and $\phi'(0) = 0 = \phi'(\pi)$ in the case of boundary conditions (3.3). For any function ϕ on $[0, \pi]$, let $\|\phi\|$ denote the supremum of $|\phi(x)|$ on $[0, \pi]$. Then B^0 and B^1 are Banach spaces with norms $\|\phi\|_0 := \|\phi\|$ and $\|\phi\|_1 := \|\phi\| + \|\phi'\|$, respectively. The imbedding of B^1 in B^0 is a compact linear operator.

Stressing the dependence on the initial value, we will often write $u(x, t, \phi)$ instead of $u(x, t)$ for solutions of (3.1)-(3.4). We will also use the notation

$$(3.5) \quad u[t, \phi](x) := u(x, t, \phi).$$

Let $s(\phi)$ denote the maximal s such that the solution $u(\cdot, \cdot, \phi)$ exists on $[0, \pi] \times [0, s)$. Then $u[t, \phi] \in B^0$ if $0 \leq t < s(\phi)$ and $u[t, \phi] \in B^1$ if $0 < t < s(\phi)$. We also have

$$(3.6) \quad u[0, \phi] = \phi,$$

$$(3.7) \quad u[t_1, u[t_2, \phi]] = u[t_1 + t_2, \phi], \quad t_1 + t_2 < s(\phi).$$

The solutions of (3.1)-(3.4) can be considered as curves $t \rightarrow u[t, \phi]$ in B^0 , similarly to the way in which the solutions of (2.1), (2.2) could be considered as curves in \mathbb{R}^n .

The following three theorems describing the dependence of $u[t, \phi]$ on t and ϕ will be proved in the appendix, Section 9.

THEOREM 3.2. *The domain $\{(t, \phi) \mid \phi \in B^0, 0 \leq t < s(\phi)\}$ is an open subset of $[0, \infty) \times B^0$, and the mapping $(t, \phi) \rightarrow u[t, \phi]$ is continuous from this domain into B^0 .*

THEOREM 3.3. *The mapping $(t, \phi) \rightarrow u[t, \phi]$ is continuous from the domain $\{(t, \phi) \mid \phi \in B^0, 0 < t < s(\phi)\}$ into B^1 .*

THEOREM 3.4. *For each $r > 0$ there exists a $T > 0$ such that*

$$T < \inf\{s(\phi) \mid \phi \in B^0, \|\phi\|_0 \leq r\}$$

and

$$\sup\{\|u[t, \phi]\|_1 \mid \phi \in B^0, \|\phi\|_0 \leq r\} < \infty$$

if $0 < t \leq T$.

We conclude this section by introducing a Lyapunov functional for problem (3.1)-(3.3), analogous to the Lyapunov function for a gradient system described in Section 2. For $\phi \in B^1$ define

$$(3.8) \quad v(\phi) := \int_0^\pi \left(\frac{1}{2} \phi'(x)^2 - \int_0^{\phi(x)} f(x, y) dy \right) dx.$$

THEOREM 3.5. *For each $\phi \in B^0$ the function $t \rightarrow v(u[t, \phi])$ is differentiable on $(0, s(\phi))$ and*

$$(3.9) \quad \frac{d}{dt} v(u[t, \phi]) = - \int_0^\pi u_t(x, t, \phi)^2 dx.$$

Let us prove this theorem here, under the assumption that u_{xt} exists and is continuous on $[0, \pi] \times (0, s(\phi))$. Then

$$\begin{aligned} \frac{d}{dt} v(u[t, \phi]) &= \int_0^\pi (u_x u_{xt} - f(x, u(x)) u_t) dx \\ &= \left[u_x u_t \right]_0^\pi - \int_0^\pi (u_{xx} + f(x, u(x)) u_t) dx \\ &= - \int_0^\pi u_t^2 dx. \end{aligned}$$

In general, the above assumption is not valid. Then a more intricate argument is needed, which will be given in the appendix, Section 9.

4. LYAPUNOV FUNCTIONS FOR DYNAMICAL SYSTEMS

In Sections 2 and 3 we considered solutions of differential equations as mappings u with domain contained in $\mathbb{R} \times X$ and with range contained in X , where X is a suitable Banach space. These mappings satisfy properties of the form (3.6) and (3.7). The case that u is well-defined on $[0, \infty) \times X$ is of particular interest. In this section we will give a general theory of Lyapunov functions for dynamical systems, which can be applied to the cases described in Sections 2 and 3. The first part of this section closely follows PELETIER [1].

Let X be a complete metric space with distance function $d_X(\cdot, \cdot)$. Let a mapping $u: [0, \infty) \times X \rightarrow X$ be given such that

- (i) $u(0, \phi) = \phi$ for all $\phi \in X$,
- (ii) $u(t+s, \phi) = u(t, u(s, \phi))$ for all $t, s \geq 0$,
- (iii) the mapping $u: [0, \infty) \times X \rightarrow X$ is continuous.

Then u is called a dynamical system on X .

If $\phi \in X$, then the orbit $\gamma(\phi)$ through ϕ is defined by

$$(4.1) \quad \gamma(\phi) := \{u(t, \phi) \mid t \geq 0\}.$$

A set $S \subset X$ is called positively invariant if $\gamma(\phi) \subset S$ for all $\phi \in S$. If $\phi \in X$, then let $\omega_X(\phi)$ denote the set of all $\psi \in X$ such that $u(t_n, \phi) \rightarrow \psi$ for some sequence $t_n \rightarrow \infty$. It is called the ω -limit set of the orbit $\gamma(\phi)$. Clearly, $\omega_X(\phi)$ is a positively invariant closed subset of X , but $\omega_X(\phi)$ may be empty.

Let also a complete metric space Y be given, with distance function $d_Y(\cdot, \cdot)$, which is compactly imbedded in X , i.e., there exists a continuous injection $\iota: Y \rightarrow X$ which maps bounded subsets of Y to relatively compact subsets of X . Suppose that u satisfies three additional properties:

- (iv) If $t > 0$ and $\phi \in X$, then $u(t, \phi) \in Y$,
- (v) the mapping $u: (0, \infty) \times X \rightarrow Y$ is continuous,
- (vi) for each bounded subset S of X there exists a $t_0 > 0$ such that $u(t, S)$ is a bounded subset of Y if $0 < t \leq t_0$.

The following lemma shows that the properties (i)-(vi) imply a much stronger version of property (vi).

LEMMA 4.1. *If S is a bounded subset of X , then for each $t > 0$ $u(t,S)$ is a relatively compact subset of Y .*

PROOF. Let S be a bounded subset of X and let $t > 0$. There exists a t_0 , $0 < t_0 < t$, such that $u(t_0,S)$ is a bounded subset of Y . Hence $u(t_0,S) \subset S_1$, where S_1 is a certain compact subset of X . Then $u(t,S) = u(t-t_0, u(t_0,S)) \subset u(t-t_0, S_1)$. By property (v) the set $u(t-t_0, S_1)$ is compact in Y . \square

COROLLARY 4.2. *Let $\phi \in X$ be such that $\gamma(\phi)$ is bounded in X . Then for each $\tau > 0$ the set $\gamma_\tau(\phi) := \{u(t,\phi) \mid t \geq \tau\}$ is relatively compact in Y .*

With respect to the topology of Y we can define the ω -limit set $\omega_Y(\phi)$, $\phi \in X$, as the set of all $\psi \in Y$ such that $d_Y(u(t_n, \phi), \psi) \rightarrow 0$ for some sequence $t_n \rightarrow \infty$. Note that $\omega_Y(\phi)$ is closed in Y and that $\omega_Y(\phi) \subset \omega_X(\phi)$. If $\gamma(\phi)$ is bounded in X , then by Corollary 4.2 the inverse inclusion also holds. Hence, if $\gamma(\phi)$ is bounded in X , then we may write $\omega(\phi)$ without reference to X or Y .

THEOREM 4.3. *Let $\phi \in X$ such that $\gamma(\phi)$ is bounded in X . Then*

- (a) $\omega(\phi)$ is nonempty
- (b) $\omega(\phi)$ is compact in the topology of Y ,
- (c) $\omega(\phi)$ is connected in the topology of Y .

PROOF.

- (a) Let $t_n \rightarrow \infty$. Then, by Corollary 4.2, the sequence $\{u(t_n, \phi)\}$ is relatively compact.
- (b) $\omega(\phi)$ is the intersection of the closures of $\gamma_\tau(\phi)$, $\tau > 0$.
- (c) Suppose that $\omega(\phi)$ is not connected in Y . Then $\omega(\phi)$ is the disjoint union of two nonempty closed subsets S_1 and S_2 . Since $\omega(\phi)$ is compact in Y , the same holds for S_1 and S_2 , and $\rho := d_Y(S_1, S_2) > 0$. Pick $\psi_1 \in S_1$, $\psi_2 \in S_2$. We can choose sequences $s_n \rightarrow \infty$, $t_n \rightarrow \infty$ such that $s_n < t_n < s_{n+1}$ for all n and $d_Y(u(s_n, \phi), \psi_1) < \frac{1}{3}\rho$, $d_Y(u(t_n, \phi), \psi_2) < \frac{1}{3}\rho$. Hence there is a sequence $\{r_n\}$ such that $s_n < r_n < t_n$ for all n and $d_Y(u(r_n, \phi), S_i) \geq \frac{1}{2}\rho$, $i = 1, 2$.

By Corollary 4.2, the sequence $\{u(r_n, \phi)\}$ has a subsequence converging to some $\chi \in Y$ in the topology of Y . Then $\chi \in \omega(\phi)$, but, on the other hand, $d_Y(\chi, \omega(\phi)) \geq \frac{1}{2}\rho$. This is a contradiction. \square

An element $\phi \in X$ is called an equilibrium point of the dynamical system if $\gamma(\phi) = \{\phi\}$. Note that all equilibrium points belong to Y .

We say that an orbit $\gamma(\phi)$, $\phi \in X$, stabilizes in X (or Y) if there exists $\psi \in X$ (or $\in Y$) such that $u(t, \phi) \rightarrow \psi$ as $t \rightarrow \infty$ in the topology of X (or of Y). It is easily verified that an orbit $\gamma(\phi)$ stabilizes in X if and only if it stabilizes in Y . Furthermore, if $u(t, \phi) \rightarrow \psi$ as $t \rightarrow \infty$, then ψ is an equilibrium point. Finally, an orbit $\gamma(\phi)$ stabilizes if and only if $\gamma(\phi)$ is bounded in X and $\omega(\phi)$ consists of exactly one point.

An equilibrium point ϕ is called isolated in X (or in Y) if some neighbourhood of ϕ in X (or in Y) contains no other equilibrium points. Again it can be verified that an equilibrium point is isolated in X if and only if it is isolated in Y .

Let a continuous function $V: Y \rightarrow \mathbb{R}$ be given. For $\phi \in Y$ define

$$(4.2) \quad \dot{V}(\phi) := \limsup_{t \rightarrow 0} \frac{V(u(t, \phi)) - V(\phi)}{t}.$$

Let V have the following two properties:

- (vii) $\dot{V}(\phi) \leq 0$ for all $\phi \in Y$,
- (viii) If $\phi \in Y$ and $\dot{V}(\phi) = 0$, then ϕ is an equilibrium point.

Then V is called a strict Lyapunov function on Y with respect to the dynamical system.

Note that for each $\phi \in X$ the function $t \rightarrow V(u(t, \phi))$ is nonincreasing on $(0, \infty)$ and that it is strictly decreasing on $(0, \infty)$ except if $u(t_0, \phi)$ is an equilibrium point for some $t_0 > 0$.

THEOREM 4.4. *Let $\phi \in X$ such that $\gamma(\phi)$ is bounded in X .*

- (a) *All elements of $\omega(\phi)$ are equilibrium points.*
- (b) *If all equilibrium points in X are isolated, then $\omega(\phi)$ consists of exactly one equilibrium point ψ .*

PROOF.

- (a) Let $\psi \in \omega(\phi)$ and $t_n \rightarrow \infty$ such that $d_Y(u(t_n, \phi), \psi) \rightarrow 0$. Then for each $\tau \geq 0$ $d_Y(u(t_n + \tau, \phi), u(\tau, \psi)) \rightarrow 0$ and $V(u(t_n + \tau, \phi)) \rightarrow V(u(\tau, \psi))$. Since $V(u(t, \phi))$ is nonincreasing in t we have

$$V(u(t_n, \phi)) \geq V(u(t_n + \tau, \phi)) \geq V(\psi) \geq V(u(\tau, \psi)).$$

Hence $V(u(\tau, \psi)) = V(\psi)$ for each $\tau \geq 0$, i.e. $\dot{V}(\psi) = 0$. It follows that ψ is an equilibrium point.

- (b) $\omega(\phi)$ is discrete, connected and nonempty. Hence it must consist of one point. \square

If X is bounded and if all equilibrium points are isolated, then it follows from Theorem 4.4 that each orbit $\gamma(\phi)$ stabilizes. Let for an equilibrium point v the so-called domain of attraction $A(v)$ denote the set of all $\phi \in X$ such that $u(t, \phi) \rightarrow v$ as $t \rightarrow \infty$. Then, under the above conditions, X is the disjoint union of all domains of attraction $A(v)$.

We now turn our attention to the examination of stability of equilibrium points. It is still assumed that the properties (i)-(viii) are valid. For the moment let Z denote either X or Y .

DEFINITION 4.5. Let $v \in Y$ be an equilibrium point.

- (a) v is called *Z-stable* if for each $\varepsilon > 0$ and $T > 0$ there exists $\delta > 0$ such that:

$$\left. \begin{array}{l} \phi \in Z, \\ d_Z(\phi, v) < \delta, \\ t \geq T \end{array} \right\} \Rightarrow d_Z(u(t, \phi), v) < \varepsilon.$$

- (b) v is called *Z-attractive* if there exists $\eta > 0$ such that:

$$\left. \begin{array}{l} \phi \in Z, \\ d_Z(\phi, v) < \eta \end{array} \right\} \Rightarrow \lim_{t \rightarrow \infty} d_Z(u(t, \phi), v) = 0$$

- (c) v is called *Z-asymptotically stable* if v is both *Z-stable* and *Z-attractive*.

(d) v is called *Z-unstable* if v is not Z-stable.

It is not difficult to prove that an equilibrium point v is X-stable, X-attractive, X-asymptotically stable or X-unstable if and only if v is Y-stable, Y-attractive, Y-asymptotically stable or Y-unstable, respectively. Observe that v is attractive if and only if it is an interior point (in X or Y) of its domain of attraction $A(v)$.

The following theorem is a refinement of Theorem I.7.1.

THEOREM 4.6. *If V attains a strict local minimum in an equilibrium point v , then v is stable.*

PROOF. Let v be an equilibrium point such that V attains a strict local minimum in v . Choose $r > 0$ such that $V(\phi) > V(v)$ if $0 < d_Y(\phi, v) < r$. Choose ε , $0 < \varepsilon < r$, and $T > 0$. There exists $\delta_1 > 0$ such that $d_Y(u(t, \phi), v) < \varepsilon$ if $d_Y(\phi, v) < \delta_1$ and $T \leq t \leq 2T$. Let $S := \{\phi \in Y \mid d_Y(\phi, v) < \varepsilon, d_Y(u(T, \phi), v) = \varepsilon\}$. If S is empty, then we are done.

Otherwise, since S is relatively compact, there exists $\psi \in Y$ such that $d_Y(\psi, v) = \varepsilon$ and $\inf\{V(\phi) \mid \phi \in S\} = V(\psi)$. Hence

$\rho := \inf\{V(\phi) \mid \phi \in S\} - V(v) > 0$. There exists δ , $0 < \delta \leq \delta_1$, such that $V(\phi) - V(v) < \rho$ if $d_Y(\phi, v) < \delta$. Fix $\phi \in Y$ with $d_Y(\phi, v) < \delta$. Then, for $T \leq t \leq 2T$, $d_Y(u(t, \phi), v) < \varepsilon$. We claim that $d_Y(u(t, \phi), v) < \varepsilon$ for all $t \geq T$, for otherwise there exists $t_0 \geq 2T$ such that $d_Y(u(t_0, \phi), v) = \varepsilon$ and $d_Y(u(t_0 - T, \phi), v) < \varepsilon$. Hence $u(t_0, \phi) \in S$ and $V(v) + \rho > V(\phi) \geq V(u(t_0, \phi)) \geq V(v) + \rho$. This is a contradiction. \square

The last theorem of this section incorporates Theorems I.7.2 and I.7.3.

THEOREM 4.7. *Let v be an isolated equilibrium point. Then the following four statements are equivalent:*

- (a) v is attractive,
- (b) v is stable,
- (c) v is asymptotically stable,
- (d) V attains a strict local minimum in v .

PROOF. (a) \Rightarrow (d): Let v be attractive. Choose $\eta > 0$ such that $d_Y(u(t, \phi), v) \rightarrow 0$ as $t \rightarrow \infty$ if $d_Y(\phi, v) < \eta$. Then $V(\phi) > V(v)$ if

$0 < d_Y(\phi, v) < \eta$, for otherwise there exists ϕ , $0 < d_Y(\phi, v) < \eta$, such that for all $t \geq 0$ we have

$$V(v) \leq V(u(t, \phi)) \leq V(\phi) \leq V(v).$$

Hence $V(u(t, \phi)) = V(v)$ for all $t \geq 0$, i.e. $\phi = u(t, \phi) = v$. This is a contradiction.

(d) \Rightarrow (b): Apply Theorem 4.6.

(b) \Rightarrow (c): Let v be stable. Let $\varepsilon > 0$ such that there are no equilibrium points $\phi \neq v$ with $d_Y(\phi, v) \leq \varepsilon$. There exists $\delta > 0$ such that $d_Y(u(t, \phi), v) < \varepsilon$ if $d_Y(\phi, v) < \delta$ and $t \geq 1$. Hence, if $d_Y(\phi, v) < \delta$, then $\gamma(\phi)$ is bounded in Y and $\omega(\phi)$ is nonempty and consists of equilibrium points ψ such that $d_Y(\psi, v) \leq \varepsilon$. Hence $\omega(\phi) = \psi$.

(c) \Rightarrow (a): obvious. \square

Note that if V attains a strict local minimum in an equilibrium point v with respect to the topology of Y , then this is also true with respect to the topology of X .

5. APPLICATION OF THE PRECEDING THEORY TO NONLINEAR PARABOLIC INITIAL BOUNDARY VALUE PROBLEMS

In this section the results of Section 4 will be applied to solutions of problem (3.1)-(3.4). Using the notation of Section 3, let X be a nonempty closed subset of B^0 such that, for each $\phi \in X$, $s(\phi) = \infty$ and $u[t, \phi] \in X$ for all $t \geq 0$. Let Y be the intersection of X and B^1 , and let Y have the topology induced by B^1 . Let V be the restriction to Y of the function defined by (3.8). It follows from formulas (3.6), (3.7) and (3.9) and Theorems 3.2, 3.3 and 3.4 that, with these choices of X , Y , u and V , the properties (i)-(viii) of Section 4 are satisfied. Then all conclusions of Section 4 are valid.

We will mention two examples of choosing a suitable subset X of B^0 . First, if there exists $K > 0$ such that $|f(x, y)| \leq K(|y| + 1)$ for all $(x, y) \in [0, \pi] \times \mathbb{R}$, then Theorem II.3.3 shows that we can choose X as the whole space B^0 . For the second example we need the concept of upper and lower solutions, which were also introduced in Chapter III.

DEFINITION 5.1. An *upper equilibrium solution* of (3.1) and (3.2) or (3.3) is a function $\chi \in C^2([0, \pi])$ such that

$$\begin{aligned} \chi''(x) + f(x, \chi(x)) &\leq 0, & 0 \leq x \leq \pi, \\ \chi(0) &\geq 0, & \chi(\pi) \geq 0 \text{ in the case of (3.2),} \\ \chi'(0) &\leq 0, & \chi'(\pi) \geq 0 \text{ in the case of (3.3).} \end{aligned}$$

A *lower equilibrium solution* of (3.1) and (3.2) or (3.3) is defined similarly, but with all inequality signs reversed.

Now suppose that χ and ψ are upper and lower equilibrium solutions such that $\chi \geq \psi$ on $[0, \pi]$. Choose X as the set of all $\phi \in B^0$ such that $\chi \geq \phi \geq \psi$ on $[0, \pi]$. Then it follows from Theorem II.1.9 in the Dirichlet case and from Lemma 9.2 (see Appendix) in the Neumann case that $u[t, \phi] \in X$ if $\phi \in X$ and $0 \leq t < s(\phi)$. Finally, since X is bounded, it follows from Lemma 9.3 (see Appendix) that $s(\phi) = \infty$ for each $\phi \in X$.

In the last example it is particularly convenient to choose χ and ψ as constants c_1 and c_2 , respectively, such that $c_1 > c_2$ (or $c_1 > 0 > c_2$ in the Dirichlet case) and $f(x, c_1) \leq 0$, $f(x, c_2) \geq 0$ on $[0, \pi]$.

Let us next apply the results of Section 4. By an equilibrium solution of (3.1) and (3.2) or (3.3) we mean a function $v \in C^2([0, \pi]) \cap B^1$ such that

$$(5.1) \quad v''(x) + f(x, v(x)) = 0, \quad 0 \leq x \leq \pi.$$

As a corollary to Theorem 9.4 we have:

THEOREM 5.2. *Let χ and ψ be upper and lower equilibrium solutions, respectively, of problem (3.1)-(3.3), such that $\chi \geq \psi$ on $[0, \pi]$. Suppose that all equilibrium solutions of (3.1)-(3.3) lying between ψ and χ are isolated. Then all solutions $t \rightarrow u[t, \phi]$ of (3.1)-(3.4) with initial value ϕ lying between ψ and χ stabilize (i.e. tend, in C^1 -norm, to an equilibrium solution as $t \rightarrow \infty$).*

From now on suppose that X and Y are subsets of B^0 and B^1 , respectively, as described in the beginning of this section. Then Definition 4.5 defines various forms of stability for equilibrium solutions, and Theorems 4.6 and 4.7 give necessary and sufficient conditions for stability in terms of minimum properties of V .

It follows, by a Taylor expansion of the integrand of the outer integral in (3.8), that for fixed $\phi \in Y$

$$(5.2) \quad V(\phi+\psi) = V(\phi) + L_{\phi}(\psi) + \frac{1}{2}Q_{\phi}(\psi) + o(\|\psi\|_0^2)$$

for $\psi \in B^1$, $\|\psi\|_0 \rightarrow 0$, where

$$(5.3) \quad L_{\phi}(\psi) := \int_0^{\pi} (\phi'(x)\psi'(x) + f(x, \phi(x))\psi(x)) dx,$$

and

$$(5.4) \quad Q_{\phi}(\psi) := \int_0^{\pi} (\psi'(x)^2 - f_{yy}(x, \phi(x))\psi(x)^2) dx.$$

Note that L_{ϕ} and Q_{ϕ} are continuous on B^1 . If v is an equilibrium solution of (3.1)-(3.3), then

$$L_v(\psi) = - \int_0^{\pi} (v'' + f(x, v(x))\psi(x)) dx = 0, \quad \psi \in B^1.$$

THEOREM 5.3. *Let $v \in Y$ be an equilibrium solution of (3.1)-(3.3).*

(a) *If there exists $a > 0$ such that*

$$(5.5) \quad Q_v(\psi) \geq a\|\psi\|_0^2 \quad \text{for all } \psi \in B^1,$$

then v is stable.

(b) *If v is an isolated equilibrium solution and if (5.5) holds with $a > 0$, then v is asymptotically stable.*

(c) *Let v be an interior point of Y considered as a subset of B^1 and let v be an isolated equilibrium solution. If v is stable, then $Q_v(\psi) \geq 0$ for all $\psi \in B^1$.*

PROOF. Since v is an equilibrium solution we have

$$(5.6) \quad V(v+\psi) = V(v) + \frac{1}{2}Q_v(\psi) + o(\|\psi\|_0^2)$$

for $\psi \in B^1$, $\|\psi\|_0 \rightarrow 0$.

(a) It follows from (5.5) and (5.6) that

$$V(v+\psi) - V(v) \geq \frac{1}{4}a\|\psi\|_0^2$$

for $\psi \in Y$, $\|\psi\|_0$ sufficiently small. Hence V attains a strict local minimum in v with respect to the topology of X .

(b) Apply Theorem 4.7.

(c) Since v is isolated and stable, V attains a strict local minimum in v by Theorem 4.7. Suppose that there exists $\psi \in B^1$ such that $Q_V(\psi) < 0$. Then it follows from (5.6) that

$$V(v+c\psi) - V(v) = \frac{1}{2}c^2 Q_V(\psi) + o(c^2) \quad \text{for } c \rightarrow 0.$$

Hence, for sufficiently small $c \neq 0$ we have $V(v+c\psi) - V(v) < 0$, $v + c\psi \in Y$. This is a contradiction. \square

The above theorem relates the stability properties of an equilibrium solution v to the sign of

$$(5.7) \quad \inf\{Q_V(\psi) \mid \psi \in B^1, \|\psi\|_0 = 1\}.$$

In Section 6 we will show that the number defined by (5.7) has the same sign as the smallest eigenvalue λ of the Sturm-Liouville problem

$$(5.8) \quad w''(x) + (f_y(x, v(x)) + \lambda)w(x) = 0, \quad w \in C^2([0, \pi]) \cap B^1.$$

6. PRELIMINARIES ON REGULAR STURM-LIOUVILLE PROBLEMS

Let $q \in C([0, \pi])$ and $\lambda \in \mathbb{C}$. Consider the regular Sturm-Liouville problem

$$(6.1) \quad w''(x) + (\lambda - q(x))w(x) = 0, \quad 0 \leq x \leq \pi,$$

with boundary conditions

$$(6.2) \quad w(0) = 0 = w(\pi)$$

or

$$(6.3) \quad w'(0) = 0 = w'(\pi).$$

If for a certain λ there exists a solution $w \in C^2([0, \pi])$ of problem (6.1)-(6.3) which is not identically zero, then λ is called an eigenvalue and w a corresponding eigenfunction of the problem.

THEOREM 6.1 (cf. CODDINGTON & LEVINSON, [6, Ch.8, Theorem 2.1]). *All eigenvalues of problem (6.1)-(6.3) are real and simple. They form a monotone increasing sequence $\lambda_0, \lambda_1, \lambda_2, \dots$ tending to ∞ . An eigenfunction corresponding with λ_n has exactly n simple zeros on $(0, \pi)$.*

Let ϕ_n denote the eigenfunction corresponding with λ_n which is normalized such that $\int_0^\pi \phi_n(x)^2 dx = 1$ and either $\phi_n'(0) > 0$ or $\phi_n(0) > 0$. It follows immediately from (6.1)-(6.3) that

$$(6.4) \quad \int_0^\pi \phi_m(x) \phi_n(x) dx = \delta_{m,n}.$$

If $f \in L^2([0, \pi])$, then let

$$(6.5) \quad \hat{f}(n) := \int_0^\pi f(x) \phi_n(x) dx, \quad n = 0, 1, 2, \dots,$$

denote the Fourier coefficients of f with respect to the orthonormal system $\{\phi_n\}$.

THEOREM 6.2 (cf. CODDINGTON & LEVINSON [6, Ch.7, Section 4]).

(a) *If $f \in L^2([0, \pi])$, then*

$$(6.6) \quad f(x) = \sum_{n=0}^{\infty} \hat{f}(n) \phi_n(x), \quad 0 \leq x \leq \pi,$$

with convergence in L^2 sense.

(b) *If $f \in B^1 \cap C^2([0, \pi])$, then (6.6) holds with uniform convergence on $[0, \pi]$.*

THEOREM 6.3. If $f \in B^1 \cap C^2([0, \pi])$, then

$$(6.7) \quad f'(x) = \sum_{n=0}^{\infty} f^{\wedge}(n) \phi_n'(x),$$

with uniform convergence on $[0, \pi]$.

PROOF. Let $g := f'' - qf$. Then $g \in L^2([0, \pi])$ and

$$\begin{aligned} g^{\wedge}(n) &= \int_0^{\pi} (f'' - qf) \phi_n dx = \int_0^{\pi} f(\phi_n'' - q\phi_n) dx = \\ &= -\lambda_n \int_0^{\pi} f \phi_n dx = -\lambda_n f^{\wedge}(n). \end{aligned}$$

$$\text{Hence} \quad f'' - qf = - \sum_{n=0}^{\infty} \lambda_n f^{\wedge}(n) \phi_n = \sum_{n=0}^{\infty} f^{\wedge}(n) (\phi_n'' - q\phi_n),$$

with convergence in L^2 -sense. Thus $f'' = \sum_{n=0}^{\infty} f^{\wedge}(n) \phi_n''$ in L^2 -sense,

$$\begin{aligned} (*) \quad f'(x) - f'(0) &= \sum_{n=0}^{\infty} f^{\wedge}(n) (\phi_n'(x) - \phi_n'(0)) \text{ with uniform convergence,} \\ f(x) - f(0) - f'(0)x &= \\ &= \sum_{n=0}^{\infty} f^{\wedge}(n) (\phi_n(x) - \phi_n(0) - \phi_n'(0)x) \text{ with uniform convergence.} \end{aligned}$$

By substituting (6.6) in this last equality it follows that

$$f'(0) = \sum_{n=0}^{\infty} f^{\wedge}(n) \phi_n'(0).$$

Hence formula (*) yields (6.7). \square

COROLLARY 6.4. The class of all finite linear combinations of eigenfunctions ϕ_n is dense in B^1 .

PROOF. Because of Theorems 6.2(b) and 6.3 this class is dense in $B^1 \cap C^2([0, \pi])$ with respect to the C^1 -norm. Furthermore, $B^1 \cap C^2([0, \pi])$ is dense in B^1 . \square

Let

$$(6.8) \quad Q(f, g) := \int_0^{\pi} (f'g' + qfg) dx, \quad f, g \in B^1.$$

Q is a bounded symmetric bilinear functional on B^1 . Integration by parts gives

$$(6.9) \quad Q(\phi_m, \phi_n) = \lambda_m \delta_{m,n}.$$

THEOREM 6.5. *If $f \in B^1$, then*

$$Q(f, f) \geq \lambda_0 \int_0^{\pi} f^2 dx.$$

The equality sign holds if and only if $f = \text{const. } \phi_0$.

PROOF. By approximation of $f \in B^1$ with finite linear combinations of eigenfunctions ϕ_n , it follows, in view of (6.9) and Corollary 6.4, that

$$Q(f, f) \geq \lambda_0 f^{\wedge}(0)^2 + \lambda_1 \int_0^{\pi} (f - f^{\wedge}(0)\phi_0)^2 dx \geq \lambda_0 \int_0^{\pi} f^2 dx. \quad \square$$

LEMMA 6.6. *There exists a $c > 0$ such that*

$$\int_0^{\pi} ((f')^2 + f^2) dx \geq c \|f\|_0^2, \quad \text{for all } f \in B^1,$$

where $\|f\|_0$ denotes the sup-norm on $[0, \pi]$.

PROOF. Let $x_0 \in [0, \pi]$ such that $|f(x)|$ attains an absolute minimum in x_0 .

Then

$$\begin{aligned} f(x) &= f(x_0) + \int_{x_0}^x f'(y) dy, \\ |f(x)| &\leq \pi^{-\frac{1}{2}} \left(\int_0^{\pi} f(y)^2 dy \right)^{\frac{1}{2}} + \left(\int_{x_0}^x dy \right)^{\frac{1}{2}} \left| \int_{x_0}^x f'(y)^2 dy \right|^{\frac{1}{2}} \\ &\leq \pi^{-\frac{1}{2}} \left(\int_0^{\pi} f(y)^2 dy \right)^{\frac{1}{2}} + \pi^{\frac{1}{2}} \left(\int_0^{\pi} f'(y)^2 dy \right)^{\frac{1}{2}}. \end{aligned} \quad \square$$

THEOREM 6.7. *If $\lambda_0 > 0$ then there exists an $a > 0$ such that*

$$Q(f, f) \geq a \|f\|_0^2, \quad \text{for all } f \in B^1.$$

If $\lambda_0 < 0$ then $Q(f, f) < 0$ for some $f \in B^1$.

PROOF. Let $\lambda_0 > 0$ and $f \in B^1$. By Theorem 6.5 and Lemma 6.6 we have

$$Q(f, f) \geq \lambda_0 \int_0^\pi f^2 dx$$

and

$$\begin{aligned} Q(f, f) &= \int_0^\pi (f^2 + (f')^2) dx + \int_0^\pi (q-1) f^2 dx \geq \\ &\geq c \|f\|_0^2 - \|q-1\|_0 \int_0^\pi f^2 dx. \end{aligned}$$

Hence

$$(\|q-1\|_0 + \lambda_0) Q(f, f) \geq \lambda_0 c \|f\|_0^2.$$

This proves the first part of the theorem. If $\lambda_0 < 0$ then the corresponding eigenfunction ϕ_0 satisfies

$$Q(\phi_0, \phi_0) = \lambda_0 \int_0^\pi \phi_0^2 dx < 0. \quad \square$$

LEMMA 6.8. *Let ϕ and ψ be nontrivial solutions of (6.1) with eigenvalues λ and μ , respectively, such that $\phi(0) = \phi(\pi) = 0$, $\phi(x) > 0$ on $(0, \pi)$, and $\psi(x) > 0$ on $[0, \pi]$. Then $\lambda > \mu$.*

PROOF. We have the equalities

$$\begin{aligned} \psi(0)\phi'(0) - \psi(\pi)\phi'(\pi) &= \left. \psi' \phi - \psi \phi' \right|_0^\pi = \\ &= \int_0^\pi (\psi'' \phi - \psi \phi'') dx = (\lambda - \mu) \int_0^\pi \psi \phi dx. \end{aligned}$$

Now use $\phi'(0) > 0$, $\phi'(\pi) < 0$, $\int_0^\pi \psi \phi \, dx > 0$. \square

For fixed q let λ_0 denote the smallest eigenvalue of the Neumann problem (6.1), (6.3) and μ_0 the smallest eigenvalue of the Dirichlet problem (6.1), (6.2).

COROLLARY 6.9. $\lambda_0 < \mu_0$.

PROOF. Apply Lemma 6.8. \square

THEOREM 6.10. *We have*

$$\inf\{q(x) \mid 0 \leq x \leq \pi\} \leq \lambda_0 \leq \pi^{-1} \int_0^\pi q \, dx.$$

The equality signs hold if and only if q is constant.

PROOF. If the first inequality were not to hold in a strict sense then $q - \lambda_0 \geq 0$ on $[0, \pi]$. Hence

$$w''(x) = (q(x) - \lambda_0)w(x) \geq 0 \text{ on } [0, \pi]$$

and $w''(x) > 0$ except if $q(x) = \lambda_0$. Since $w'(0), w'(\pi) = 0$, it follows that $w''(x) \equiv 0$, $q(x) \equiv \lambda_0$. For proving the second inequality use Theorem 6.5 with constant f . Here, the equality sign holds if and only if ϕ_0 is constant, i.e. $q(x) \equiv \lambda_0$ again. \square

7. FURTHER STABILITY AND INSTABILITY CRITERIA FOR EQUILIBRIUM SOLUTIONS OF PROBLEM (3.1)-(3.3)

In parts (b) and (c) of Theorem 5.3 v was required to be an isolated equilibrium solution. The following theorem gives sufficient conditions for v to be isolated.

THEOREM 7.1. *Let $v \in B^1 \cap C^2([0, \pi])$ satisfy*

$$(7.1) \quad v'' + f(x, v(x)) = 0$$

If 0 is not an eigenvalue of the problem

$$(7.2) \quad w'' + (f_y(x, v(x)) + \lambda)w = 0, \quad w \in B^1 \cap C^2([0, \pi]),$$

then the equilibrium solution v is isolated.

PROOF. First, suppose that $v(0) = 0 = v(\pi)$. Let $a_0 := v'(0)$ and define $v(x, a)$, $a \in \mathbb{R}$, as the solution of (7.1) such that $v(0, a) = 0$, $v_x(0, a) = a$. Let $w(x, a) := v_a(x, a)$. Then $w(\cdot, a)$ satisfies (7.2) with $\lambda = 0$ and $w(0, a) = 0$, $w_x(0, a) = 1$. If 0 is not an eigenvalue of (7.2) with $v(x) = v(x, a_0)$ then $v_a(\pi, a_0) = w(\pi, a_0) \neq 0$. Hence $v(\pi, a) \neq 0$ if $a \neq a_0$ and a is in a certain neighbourhood of a_0 . For these values of a , equation (7.1) has no solution satisfying the boundary conditions. Hence, $v(\cdot, a_0)$ is an isolated equilibrium solution. The case of Neumann boundary conditions is proved in an analogous way. \square

Let X and Y be subsets of B^0 and B^1 , respectively, with the properties specified in Section 5.

THEOREM 7.2. Let $v \in Y$ be an equilibrium solution of problem (3.1)-(3.3). If the smallest eigenvalue λ_0 of (7.2) is positive, then v is asymptotically stable.

PROOF. By Theorem 7.1, v is isolated. It follows from Theorem 6.7 that (5.5) holds for some $a > 0$. Now apply Theorem 5.3(b). \square

THEOREM 7.3. Let v be an interior point of Y considered as a subset of B^1 , and let v be an equilibrium solution of problem (3.1)-(3.3). If the smallest eigenvalue λ_0 of (7.2) is negative, then v is unstable.

PROOF. It follows from (6.9) that $Q_v(\phi_0) < 0$. If 0 is not an eigenvalue of (7.2), then application of Theorems 7.1 and 5.3(c) proves that v is unstable. Now suppose that 0 is an eigenvalue of (7.2) and that v is not an isolated equilibrium solution. Before completing the proof we first need a lemma.

LEMMA 7.4. *Let v be an equilibrium solution of problem (3.1)-(3.3) and let the smallest eigenvalue λ_0 of (7.2) be negative. Then in a certain neighbourhood of v each equilibrium solution w of problem (3.1)-(3.3) has the property that $w-v$ changes sign on $(0,\pi)$.*

PROOF. Suppose that the conclusion of the lemma is wrong. Then there is a sequence of equilibrium solutions $\{v+\psi_m\}$ tending to v and such that ψ_m or $-\psi_m$ is nonnegative on $(0,\pi)$ but not identically zero. From (7.1) and the fact that

$$(v+\psi_m)'' + f(x, v(x)+\psi_m(x)) = 0,$$

we have

$$\psi_m'' + f_y(x, v(x))\psi_m + g_m(x) = 0,$$

where $g_m(x) = o(|\psi_m(x)|)$ as $m \rightarrow \infty$, uniformly in x on $[0,\pi]$. On the other hand, we have

$$\phi_0'' + f_y(x, v(x))\phi_0 + \lambda_0\phi_0 = 0,$$

where ϕ_0 is the eigenfunction corresponding with λ_0 . Since ψ_m and ϕ_0 satisfy the same boundary conditions, it follows that

$$\int_0^\pi \phi_0(g_m - \lambda_0\psi_m) dx = 0.$$

Hence

$$\int_0^\pi \phi_0\psi_m(\lambda_0 + o(1)) dx = 0 \quad \text{as } m \rightarrow \infty.$$

Because $\phi_0 > 0$ on $(0,\pi)$, it follows that $\psi_m \equiv 0$ on $[0,\pi]$ for m sufficiently large. This is a contradiction. \square

PROOF of THEOREM 7.3 (continued). Suppose that v is stable. Let ϕ_0 be as above. It follows from Theorem II.1.9 or Lemma 9.2 that $u[t, v+c\phi_0] \geq v$ on $[0,\pi]$ if $t \geq 0$, $c > 0$. Hence, the stability of v together with Theorem

4.4(a) shows that for each neighbourhood U of v there exists $\delta > 0$ such that if $0 < c < \delta$, then $\gamma(v+c\phi_0)$ is bounded in X and $\omega(v+c\phi_0)$ consists of equilibrium solutions $w \in U$ such that $w \geq v$ on $[0, \pi]$. If c is chosen small enough, then, by Lemma 7.4, $u[t, v+c\phi_0]$ tends to v as $t \rightarrow \infty$. However, it follows from (5.6) and Theorem 6.5 that

$$V(v+c\phi_0) = V(v) + \frac{1}{2}c^2\lambda_0 + o(c^2) < V(v)$$

for sufficiently small $c < 0$. This is in contradiction to the fact that $u[t, v+c\phi_0]$ tends to v . \square

THEOREM 7.5. *Let $v \in Y$ be an equilibrium solution of problem (3.1)-(3.3). If $f_y(x, v(x)) \leq 0$ on $[0, \pi]$, where, in the Neumann case, the equality sign does not hold for all x , then v is asymptotically stable.*

PROOF. Use Theorems 7.2 and 6.10 and Corollary 6.9. \square

THEOREM 7.6. *Let v be an equilibrium solution of the Neumann problem (3.1) and (3.3), and let v be an interior point of Y considered as a subset of B^1 . If*

$$\int_0^\pi f_y(x, v(x)) dx > 0 \text{ or if}$$

$$\int_0^\pi f_y(x, v(x)) dx = 0, \quad f_y(x, v(x)) \not\equiv 0, \text{ then}$$

v is unstable.

PROOF. Use Theorems 7.3 and 6.10. \square

8. THE INSTABILITY OF NONCONSTANT EQUILIBRIUM SOLUTIONS WHEN f DOES NOT DEPEND ON x .

Here we consider problem (3.1)-(3.4) with $f(x, u) = f(u)$ not depending on x . In that case, if v is an equilibrium solution and $w := v'$, then

$$(8.1) \quad w'' + f'(v(x))w = 0.$$

Hence, if v is nonconstant, then v' is a nontrivial solution of (7.2) with $\lambda = 0$.

THEOREM 8.1. *Let v be an equilibrium solution of the Neumann problem (3.1), (3.3). Let v be an interior point of $Y \subset B^1$. Let f not depend on x . If v is nonconstant on $[0, \pi]$, then v is unstable.*

PROOF. Let $w := v'$. Then $w \neq 0$, $w(0) = w(\pi) = 0$, and w satisfies (8.1). It follows from Corollary 6.9 that the smallest eigenvalue of (7.2) with Neumann boundary conditions is negative. Now apply Theorem 7.3. \square

A version of this theorem was earlier proved by WILLEMS & HEMKER [7] and CHAFEE [3].

THEOREM 8.2. *Let v be an equilibrium solution of the Dirichlet problem (3.1), (3.2). Let v be an interior point of $Y \subset B^1$. Let f not depend on x . If v is nonconstant on $[0, \pi]$ and has at least one zero on $(0, \pi)$, then v is unstable.*

PROOF. Let $w := v'$. Then $w'(x_1) = w'(x_2) = 0$ for certain x_1, x_2 , $0 < x_1 < x_2 < \pi$, and $w \neq 0$ on $[x_1, x_2]$. Furthermore, w satisfies (8.1). It follows from Lemma 6.8 that the smallest eigenvalue of (7.2) with Dirichlet boundary conditions is negative. Now apply Theorem 7.3. \square

See CHAFEE & INFANTE [2] for this theorem. They also prove that for certain choices of f , nonconstant stable equilibrium solutions of the Dirichlet problem exist, which have constant sign on $(0, \pi)$.

9. APPENDIX ON NONLINEAR PARABOLIC INITIAL BOUNDARY VALUE PROBLEMS

In chapter II, the existence of solutions of (3.1)-(3.4) was proved by first showing (in Section II.3.2) that solutions exist for the integral equation

$$(9.1) \quad u(x,t) = (E[t] * \tilde{\phi})(x) + \int_0^t (E[t-\tau] * \tilde{f}[\tau,u])(x) d\tau, \\ 0 \leq x \leq \pi, \quad 0 \leq t \leq s.$$

In this equation, which is analogous to (2.3), the following notation is used:

$$(9.2) \quad f[t,u](x) := f(x,u(x,t)),$$

$\tilde{\phi}$ and $\tilde{f}[t,u]$ denote 2π -periodic continuations to \mathbb{R} of ϕ and $f[t,u]$, respectively, which are odd in case of (3.2) and even in case of (3.3),

$$(9.3) \quad E[t](x) := \frac{1}{2\sqrt{\pi t}} \exp\left(-\frac{x^2}{4t}\right), \quad t > 0, \quad x \in \mathbb{R},$$

and

$$(9.4) \quad (E[t] * \tilde{\phi})(x) := \int_{-\infty}^{\infty} E[t](x-\xi) \tilde{\phi}(\xi) d\xi.$$

Remember (cf. (II.3.5) and (II.3.10)) that

$$(9.5) \quad \|E[t] * \tilde{\phi}\| \leq \|\phi\|,$$

and

$$(9.6) \quad \left\| \frac{\partial}{\partial x} (E[t] * \tilde{\phi}) \right\| \leq (\pi t)^{-\frac{1}{2}} \|\phi\|.$$

LEMMA 9.1. *Let $r_1 > r > 0$. Then there exists $s > 0$ such that for each $\phi \in B^0$ with $\|\phi\|_0 \leq r$ the equation (9.1) has a unique solution $u \in C([0,\pi] \times [0,s])$ with $|u(x,t)| \leq r_1$ on $[0,\pi] \times [0,s]$.*

PROOF. Let M_0 and M_1 denote the suprema of $|f(x,y)|$ and $|f_y(x,y)|$, respectively, on $[0,\pi] \times [-r_1,r_1]$. Let $s := \min\{M_0^{-1}(r_1-r), \frac{1}{2}M_1^{-1}\}$. Let W be the class of all $u \in C([0,\pi] \times [0,s])$ such that $|u(x,t)| \leq r_1$ on $[0,\pi] \times [0,s]$, and let $\|u\|_W$ be the sup-norm for $u \in W$. Fix $\phi \in B^0$ with $\|\phi\|_0 \leq r$ and define for $u \in W$:

$$(Au)(x,t) := (E[t]*\tilde{\phi})(x) + \int_0^t (E[t-\tau]*\tilde{f}[\tau,u])(x) d\tau.$$

Then Au is continuous on $[0,\pi] \times [0,s]$ (cf. section II.3.1) and

$$\|Au\|_W \leq \|\phi\|_0 + tM_0 \leq r + sM_0 \leq r_1.$$

Hence $Au \in W$. Furthermore, if $u, v \in W$, then

$$\|Au-Av\|_W \leq tM_1\|u-v\|_W \leq sM_1\|u-v\|_W \leq \frac{1}{2}\|u-v\|_W.$$

Hence A is a contraction on the complete metric space W . It follows that A has a unique fixed point on W . \square

It was proved in Section II.3.3 that if $u \in C([0,\pi] \times [0,s])$ satisfies (9.1), then u_x, u_{xx}, u_t are continuous on $[0,\pi] \times (0,s)$ and u satisfies (3.1)-(3.4).

PROOF of THEOREM 3.2. We already know that for each $\phi \in B^0$ the mapping $t \rightarrow u[t,\phi]$ is continuous from $[0,s(\phi))$ into B^0 . Next, fix $\phi \in B^0$ and choose $T, 0 < T < s(\phi)$, and $\epsilon, \epsilon > 0$. It is sufficient to prove that there exists $\delta > 0$ such that if $\psi \in B^0, \|\psi-\phi\|_0 \leq \delta$, then $T < s(\psi)$ and $\|u[t,\phi]-u[t,\psi]\|_0 \leq \epsilon$ for $0 \leq t \leq T$. Let

$$r := \sup_{0 \leq t \leq T} \|u[t,\phi]\| + \epsilon$$

and choose $r_1 > r$. Let M_0, M_1 and s be as in the proof of Lemma 9.1. Choose $\psi, \chi \in B^0$ such that $\|\psi\|, \|\chi\| \leq r$. Then Lemma 9.1 ensures that $u[t,\psi]$ and $u[t,\chi]$ exist on $[0,s]$. Let $\|u[.,\psi]-u[.,\chi]\|$ denote the supremum of $\|u[t,\psi]-u[t,\chi]\|$ on $[0,s]$. Then it follows from (9.1) that

$$\begin{aligned} \|u[.,\psi]-u[.,\chi]\| &\leq \|\psi-\chi\| + M_1 s \|u[.,\psi]-u[.,\chi]\| \\ &\leq \|\psi-\chi\| + \frac{1}{2} \|u[.,\psi]-u[.,\chi]\|. \end{aligned}$$

Hence, $\|u[.,\psi]-u[.,\chi]\| \leq 2\|\psi-\chi\|$. Choose a positive integer n such that $ns > T$, and let $\delta := 2^{-n}\epsilon$. Then it follows by iteration that for each $\psi \in B^0$

with $\|\psi - \phi\| \leq \delta$ we have $T < s(\psi)$, $\|u[t, \psi]\| \leq r$ on $[0, T]$, and $\|u[t, \psi] - u[t, \phi]\| \leq \varepsilon$ on $[0, T]$. \square

PROOF of THEOREM 3.3. We already know that for each $\phi \in B^0$ the mapping $t \rightarrow u[t, \phi]$ is continuous from $(0, s(\phi))$ into B^1 . Next fix $\phi \in B^0$ and choose T and T_1 , $0 < T_1 < T < s(\phi)$, and ε , $\varepsilon > 0$. It is sufficient to prove that there exists $\delta > 0$ such that if $\psi \in B^0$, $\|\psi - \phi\| \leq \delta$, then

$$\left\| \frac{\partial}{\partial x} u[t, \phi] - \frac{\partial}{\partial x} u[t, \psi] \right\| \leq \varepsilon \quad \text{for } T_1 \leq t \leq T.$$

It follows from (9.1) that

$$(9.7) \quad u_x(x, t, \phi) = \frac{\partial}{\partial x} (E[t] * \tilde{\phi})(x) + \int_0^t \frac{\partial}{\partial x} (E(t-\tau) * f[\tau, u])(x) d\tau.$$

Let $r := \sup\{\|u[t, \phi]\| + 1 \mid 0 \leq t \leq T\}$ and let M be the supremum of $|f_y(x, y)|$ on $[0, \pi] \times [-r, r]$. Let $0 < \varepsilon_1 < 1$. By Theorem 3.2 there exists $\delta > 0$ such that if $\psi \in B^0$, $\|\psi - \phi\| \leq \delta$, then $\|u[t, \psi] - u[t, \phi]\| \leq \varepsilon_1$ for $0 \leq t \leq T$. It follows from (3.14) that for $0 < t \leq T$, $\psi \in B^0$, $\|\psi - \phi\| \leq \delta$, we have

$$\begin{aligned} \left\| \frac{\partial}{\partial x} u[t, \phi] - \frac{\partial}{\partial x} u[t, \psi] \right\| &\leq \pi^{-\frac{1}{2}} t^{-\frac{1}{2}} \|\phi - \psi\| + \\ &+ \int_0^t \pi^{-\frac{1}{2}} M \varepsilon_1 (t-\tau)^{-\frac{1}{2}} d\tau \leq \\ &\leq \pi^{-\frac{1}{2}} T_1^{-\frac{1}{2}} \varepsilon_1 (1+2MT), \end{aligned}$$

for $T_1 \leq t \leq T$. By choosing ε_1 small enough this last expression becomes less than ε . \square

PROOF of THEOREM 3.4. This follows from Lemma 9.1 and formulas (9.7) and (9.6). \square

PROOF of THEOREM 3.5. Let $\delta > 0$ and $0 < t_1 < t_2 < s(\phi)$. There exists a sequence of C^∞ -functions $\{v_n\}$ on $[\delta, \pi - \delta] \times [t_1, t_2]$ such that $v_n \rightarrow u$, $(v_n)_x \rightarrow u_x$, $(v_n)_{xx} \rightarrow u_{xx}$, $(v_n)_t \rightarrow u_t$ as $n \rightarrow \infty$, uniformly on $[\delta, \pi - \delta] \times [t_1, t_2]$.

For $\psi \in C([\delta, \pi - \delta])$ define

$$V_\delta(\psi) := \int_\delta^{\pi-\delta} \left(\frac{1}{2} \psi'(x) \right)^2 - \int_0^{\psi(x)} f(x, y) dy dx.$$

Then for $t_1 < t < t_2$ we have

$$\begin{aligned} \frac{d}{dt} V_\delta(v_n(\cdot, t)) &= \\ &= \int_\delta^{\pi-\delta} \left((v_n)_x (v_n)_{xt} - f(x, v_n(x, t)) (v_n)_t \right) dx \\ &= (v_n)_x (v_n)_t \Big|_\delta^{\pi-\delta} - \int_\delta^{\pi-\delta} \left((v_n)_{xx} + f(x, v_n(x, t)) \right) v_t dx, \end{aligned}$$

which tends to

$$\begin{aligned} &u_x u_t \Big|_\delta^{\pi-\delta} - \int_\delta^{\pi-\delta} (u_{xx} + f(x, u(x))) u_t dx = \\ &= u_x u_t \Big|_\delta^{\pi-\delta} - \int_\delta^{\pi-\delta} u_t^2 dx \end{aligned}$$

as $n \rightarrow \infty$, uniformly in t , $t_1 < t < t_2$. Since $V_\delta(v_n(\cdot, t)) \rightarrow V_\delta(u(\cdot, t))$ as $n \rightarrow \infty$, it follows that $\frac{d}{dt} V_\delta(u(\cdot, t))$ exists and equals

$$u_x u_t \Big|_\delta^{\pi-\delta} - \int_\delta^{\pi-\delta} u_t^2 dx.$$

By using a similar argument we let $\delta \downarrow 0$ and conclude that $\frac{d}{dt} V(u(\cdot, t))$ exists and equals

$$u_x u_t \Big|_0^\pi - \int_0^\pi u_t^2 dx = - \int_0^\pi u_t^2 dx. \quad \square$$

In CHAFEE & INFANTE [2], CHAFEE [3], and in Section 1.7, Theorem 3.5 was only proved under the stronger assumption that $f \in C^2([0, \pi] \times \mathbb{R})$, thus ensuring that $u_{xt} \in C((0, \pi) \times (0, s(\phi)))$.

LEMMA 9.2. *Let f be once continuously differentiable on $[0, \pi] \times \mathbb{R}$. Let $s > 0$. Let u and v be continuous on $[0, \pi] \times [0, s)$ such that u_x, v_x are continuous on $[0, \pi] \times (0, s)$ and u_{xx}, u_t, v_{xx}, v_t are continuous on $(0, \pi) \times (0, s)$. If*

$$\begin{aligned} v_{xx} - v_t + f(x, v) &\leq u_{xx} - u_t + f(x, u), & 0 < x < \pi, & 0 < t < s, \\ v(x, 0) &\geq u(x, 0), & 0 \leq x \leq \pi, & \\ v_x(0, t) &\leq u_x(0, t), & 0 < t < s, & \\ v_x(\pi, t) &\geq u_x(\pi, t), & 0 < t < s, & \end{aligned}$$

then $v(x, t) \geq u(x, t)$, $0 \leq x \leq \pi$, $0 \leq t < s$.

PROOF. Apply Theorem II.1.5 in a similar way to the proof of Corollary II.1.8. \square

LEMMA 9.3. *Let $\phi \in B^0$ such that the orbit $\{u[t, \phi] \mid 0 \leq t < s(\phi)\}$ is bounded in B^0 . Then $s(\phi) = \infty$.*

PROOF. Apply Lemma 9.1. \square

LITERATURE

- [1] PELETIER, L.A., *Stability of solutions of partial differential equations*, Nieuw Arch. Wisk. 23 (1975) 198-209.
- [2] CHAFEE, N. & E.F. INFANTE, *A bifurcation problem for a nonlinear partial differential equation of parabolic type*, *Applicable Anal.* 4 (1974) 17-37.
- [3] CHAFEE, N., *Asymptotic behavior for solutions of a one-dimensional parabolic equation with homogeneous Neumann boundary conditions*, *J. Differential Equations* 18 (1975) 111-134.

- [4] AUCHMUTY, J.F.G., *Lyapunov methods and equations of parabolic type*, in: I. Stakgold, D. Joseph & D.H. Sattinger, eds., *Nonlinear Problems in the Physical Sciences and Biology*, Lecture Notes in Math. 322 (Springer, Berlin, 1975) 1-14.
- [5] HALE, J.K., *Ordinary Differential Equations* (Wiley, New York, 1969).
- [6] CODDINGTON, E.A. & N. LEVINSON, *Theory of Ordinary Differential Equations* (McGraw-Hill, New York, 1955).
- [7] WILLEMS, G.M. & H.C. HEMKER, *The necessary and sufficient requirements for the existence of dissipative structures in (bio) chemical systems*, Report TN77/73, Mathematisch Centrum, Amsterdam, 1973.

VI. MATHEMATICAL ASPECTS OF A MODEL CHEMICAL REACTION WITH DIFFUSION

1. INTRODUCTION

The mathematical aspects of a specific nonlinear chemical system which allows more than one steady state for certain values of a parameter are investigated. This system was introduced by PRIGOGINE (see GLANSDORFF & PRIGOGINE [1]). It is not assumed to describe a known real chemical reaction; rather, it should be regarded as a model problem for biochemical systems in which spatially nonuniform stable steady states are possible. Such configurations can only arise in open systems operating far from thermodynamic equilibrium. They are usually called *dissipative structures*. Prigogine's model system deals with a reaction of the type $A + B \rightarrow D + E$, and consists of the following steps

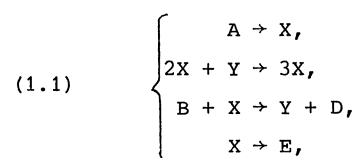

where X and Y are intermediate reactants, and A, B, D and E are initial and final products whose concentrations are imposed throughout the system.

Before formulating the mathematical problem that describes the reactions (1.1), we first give some attention to the physiochemical concepts that are involved.

DEFINITIONS 1.1. Any collection of chemicals in a given constant volume is called a *chemical system*. If a system exchanges matter or energy with its surroundings it is called an *open system*. A system is described by a number of so-called *state variables*, which may depend on time and place. The *state* of a system at a given time is defined by the values of all state variables at that time.

A system is said to be in *steady state* when the state variables are independent of time.

A steady state is called (spatially) *uniform*, if there are no spatial variations; in that case the state of the system is completely determined

by the values of the state variables at a single point of the system.

In general it is assumed that the state of the chemical system (1.1) is completely determined by the values of one thermodynamic state variable and the concentrations of the chemical components. The thermodynamic variable is chosen to be the temperature.

All reactions occurring in (1.1) are assumed to be irreversible, which means that the reverse reactions are neglected. Moreover, we make the hypothesis that temperature variations are also negligible; this means that the rate constants of the reactions (1.1) are temperature independent. For the sake of simplicity we choose them to be equal to unity.

A further hypothesis on the system (1.1) will be that in some way the concentration of B is maintained uniform and time-independent at some value. Consequently, B will only appear *parametrically* in the mathematical description of (1.1). The last hypothesis we make is that the chemical system has a finite volume, and that it is possible to describe it by a one-dimensional space variable r , which, again for simplicity, we will assume to range over values between 0 and 1.

The reaction-diffusion equations

The chemical system we are considering is subject to two mechanisms: a physical one, diffusion of molecules, and a chemical one, reaction between molecules. In the equations below the first of these is reflected in a familiar diffusion term for each reactant. The amount of the component A that disappears in a unit of time because of the first reaction in (1.1) is proportional to the amount there is at that moment. This explains the term $-A$ in the first equation below (remember that all rate constants are chosen to be equal to unity). In the case of a reaction between two or three molecules, the amount of the component that is produced by the reaction in a unit of time is proportional to the product of the concentrations of the components involved in the reaction, which is known as the law of mass action. Therefore, in the equations describing the variations with time of the concentrations of X and Y, a third degree term in the concentrations of X and Y occurs, as well as a term consisting of the product of the concentrations of B and X.

Denoting the concentrations of each reactant by the same letter as the reactant itself, the considerations above lead us to the following mass conservation equations:

$$(1.2) \quad \begin{cases} \frac{\partial A}{\partial t} = D_A \frac{\partial^2 A}{\partial r^2} - A, \\ \frac{\partial X}{\partial t} = D_X \frac{\partial^2 X}{\partial r^2} - (B+1)X + X^2 Y + A, \\ \frac{\partial Y}{\partial t} = D_Y \frac{\partial^2 Y}{\partial r^2} + BX - X^2 Y, \\ \frac{\partial D}{\partial t} = D_D \frac{\partial^2 D}{\partial r^2} + BX, \\ \frac{\partial E}{\partial t} = D_E \frac{\partial^2 E}{\partial r^2} + X, \end{cases}$$

where D_A , D_X , D_Y , D_D and D_E are the respective diffusion constants.

HYPOTHESIS 1.2. Observe that the equation for $A(r,t)$ can be solved first. If we assume that, compared with the other reactants, A diffuses rapidly through the medium, i.e. that D_A is fairly large, then A rapidly reaches its steady state $A(r)$. Then the first equation can be left out, because A is a known function satisfying

$$(1.3) \quad D_A \frac{\partial^2 A}{\partial r^2} - A = 0.$$

In this chapter we shall always assume that the above assumption holds.

Under Hypothesis 1.2 our chemical system is governed by the partial differential equations

$$(1.4) \quad \begin{cases} \frac{\partial X}{\partial t} = D_1 \frac{\partial^2 X}{\partial r^2} - (B+1)X + X^2 Y + A, \\ \frac{\partial Y}{\partial t} = D_2 \frac{\partial^2 Y}{\partial r^2} + BX - X^2 Y, \end{cases}$$

where we have written $D_1 = D_X$ and $D_2 = D_Y$, and where

$$(1.5) \quad A(r) = A_0 \cosh(D_A^{-\frac{1}{2}}(r-\frac{1}{2})) / \cosh(\frac{1}{2}D_A^{-\frac{1}{2}}).$$

is the solution of (1.3) which satisfies $A(0) = A(1) = A_0$.

Sometimes in the description of chemical systems the effect of diffusion is neglected, in which case one has to deal with a far easier system of ordinary differential equations. From a chemical point of view, neglecting the diffusion means that the reactions take place in an ideally stirred reactor. Obviously one then cannot ever get a spatially nonuniform distribution of a reactant. Since we are especially interested in nonuniform distributions, we are obliged to take the diffusion terms into account too.

HYPOTHESIS 1.3. For much of this chapter we shall be particularly interested in the case where A and B are uniformly distributed and time-invariant, that is

$$(1.6) \quad A(r,t) \equiv A_0 > 0 \quad \text{and} \quad B(r,t) \equiv B_0 > 0 \quad \text{for } 0 \leq r \leq 1, \quad t \geq 0.$$

There is, however, no need to be so restrictive in our assumptions on A and B to be successful in establishing the existence and nonnegativity of a solution of (1.4). To this end we only have to make the following requirements:

$$(1.7) \quad A(r,t) = A(r) > 0 \quad \text{and} \quad B(r,t) = B(r) \geq 0 \quad \text{for } 0 \leq r \leq 1, \quad t \geq 0;$$

$$(1.8) \quad A(0) = A(1) = A_0, \quad B(0) = B(1) = B_0;$$

$$(1.9) \quad A(\cdot), B(\cdot) \in C^0[0,1] \cap C^\infty(0,1).$$

The latter means that A and B are continuous in the closed interval and infinitely differentiable in the open interval. Infinite differentiability is not needed for the mathematical argument in this chapter (differentiability to some order would have been sufficient), but for physical and chemical reasons it would not make sense to be so specific about the data on A and B.

When A and B are constant throughout the system, (1.4) admits a solution

$$(1.10) \quad X(r,t) \equiv A \equiv A_0, \quad Y(r,t) \equiv B/A \equiv B_0/A_0,$$

for all r and t. This solution represents the *thermodynamic equilibrium* of

the system. In order to avoid spurious boundary layer effects, in view of (1.10) we impose the boundary conditions

$$(1.11) \quad \begin{cases} X(0,t) = X(1,t) = A_0, \\ Y(0,t) = Y(1,t) = B_0/A_0, \end{cases} \quad t > 0.$$

To get a well-posed mathematical problem, we also need the initial conditions

$$(1.12) \quad X(r,0) = X_0(r), \quad Y(r,0) = Y_0(r), \quad 0 \leq r \leq 1.$$

This chapter is devoted to the analysis of the initial boundary value problem given by (1.4), (1.7)-(1.9), (1.11) and (1.12). In Section 3 we prove the existence of a solution $(X(r,t), Y(r,t))$ in the neighbourhood of $t = 0$ by constructing a Green's function for the parabolic differential operator and using the standard methods for parabolic equations given in Chapter II. If the mathematical description is to be consistent with the chemical model, the values of the concentrations of X and Y may not become negative. In Section 4, therefore, it is shown that any solution of the reaction-diffusion equation obeying nonnegative initial and boundary conditions remains nonnegative for all time. The proof is based on a maximum principle for weakly coupled parabolic systems.

Sections 5-9 deal with the existence of a nonnegative solution of the reaction-diffusion problem for all time. This question is of importance, since we are, after all, especially interested in steady state solutions that are attained for $t \rightarrow \infty$. After summarizing some mathematical preliminaries in Section 6, we construct approximate weak solutions by means of the Faedo-Galerkin method. This method is not so widely known, but is of great importance in the analysis of nonlinear evolution problems. For this reason we pay a great deal of attention to the method in Sections 7 and 9. This method essentially makes use of a priori estimates for the solutions of the evolution problem at hand; for our reaction-diffusion problem these estimates are derived in Section 8.

In the remainder of this chapter we study the steady state solutions of the problem, and their dependence upon the concentration B . The existence and

uniqueness of a steady state solution for small nonnegative values of B is proved in Section 10. In Section 11 the linear stability of the steady state solutions (1.10), for a fixed constant value of A , is analyzed for varying values of B , B also being time and place independent. For any nonnegative B the solution (1.10) is said to lie on the thermodynamic branch. For B smaller than a certain critical value B_c , solution (1.10) is stable, and the system is in thermodynamic equilibrium. As B passes B_c , solution (1.10) becomes unstable. Near B_c , there exist either spatially nonuniform steady state solutions or time periodic solutions. This is the subject of Sections 11-13. The existence of such solutions branching off the thermodynamic branch at $B = B_c$ is the most important feature of the model, and its possible biological implications have initiated an interesting discussion in the literature.

In Section 14 we let A be dependent on r as given in (1.5). It is shown that the (spatial) nonuniformity in A may lead to steady state solutions with a nonuniform behaviour, located in a restricted subdomain not imposed by the position of the boundary of the medium.

This phenomenon of localized dissipative structures is an indication that Prigogine's model may help us to understand the mechanism of differentiation in developing systems, which has become well-known under the term *morphogenesis*. This topic is nowadays one of the major issues in theoretical biology. It became a subject of general interest after a study by TURING [2], in which a linear diffusion-reaction model was used to demonstrate the existence of nonuniform structures. Although Turing's model had certain shortcomings, it opened the way to a new vision in the matter of morphogenesis, which attracted quite a lot of attention amongst biologists and mathematicians. For this reason in Section 2 we give a model borrowed from ROSEN [3], which is illustrative for Turing's approach.

In this chapter we largely follow the paper of AUCHMUTY & NICOLIS [4]. We shall also use results from LIONS [5], AUCHMUTY & NICOLIS [6] and BOA & COHEN [7].

2. A SIMPLE EXAMPLE OF SPATIAL ORGANIZATION

Consider two identical boxes I and II separated by an impermeable wall, both containing chemicals U and V in a nonreacting solvent; again, we shall denote the concentration of a chemical reactant by the same letter as the chemical itself. Suppose that in each box the concentrations U and V satisfy

$$(2.1) \quad \begin{cases} \frac{dU}{dt} = 5U - 6V + 1, \\ \frac{dV}{dt} = 6U - 7V + 1. \end{cases}$$

The transformation

$$U' = U - 1, \quad V' = V - 1$$

brings the critical point $(U,V) = (1,1)$ to the origin. One gets

$$(2.2) \quad \begin{cases} \frac{dU'}{dt} = 5U' - 6V' \\ \frac{dV'}{dt} = 6U' - 7V'. \end{cases}$$

Obviously, the origin in the U', V' -plane is the only critical point, and it is a stable node. So far, nothing of interest has shown up. But now let the separating wall between box I and box II be permeable in the following manner: the diffusion of U and V between I and II is proportional to the difference between the concentrations of U and V in the boxes. We must now distinguish the concentrations of U and V in box I, U_1 and V_1 , from those in box II, U_2 and V_2 . The equations describing this situation become

$$(2.3) \quad \begin{cases} \frac{dU_1'}{dt} = 5U_1' - 6V_1' + a(U_2' - U_1'), \\ \frac{dV_1'}{dt} = 6U_1' - 7V_1' + b(V_2' - V_1'), \\ \frac{dU_2'}{dt} = 5U_2' - 6V_2' + a(U_1' - U_2'), \\ \frac{dV_2'}{dt} = 6U_2' - 7V_2' + b(V_1' - V_2'). \end{cases}$$

By an appropriate choice of the constants a and b , giving the nature of the permeability of the wall for each of the two chemicals, the origin in the (U_1', V_1', U_2', V_2') - space becomes an unstable critical point.

The variables U_1', V_1', U_2', V_2' , describing the state of the system, remain in a bounded region Ω of \mathbb{R}^4 , because the system we are considering in this section is supposed to be closed - that is, there is no inflow or outflow of matter. Notice that this is quite a different situation from the one we came across in Section 1, where the system is open, and where there is an incessant inflow of A and B and a similar outflow of D and E.

If the system (2.3), with an appropriate choice for a and b , is perturbed, as time increases U', V' will evolve from the origin along a certain orbit, until the boundary of Ω is reached in a point P. This final state is asymmetric: spatial organization has occurred.

3. THE EXISTENCE OF A SOLUTION OF THE EVOLUTION EQUATIONS IN THE NEIGHBOURHOOD OF $t = 0$

The techniques given in Chapter II are sufficient to establish the existence of a solution on an interval $0 < t < s$, for some positive s , of our initial boundary value problem for the reaction-diffusion equations, (1.4), (1.7)-(1.9), (1.11) and (1.12).

The standard approach to problems in which both boundary and initial conditions occur is to introduce new dependent variables such that the bound-

ary conditions of the new problem become homogeneous. So, we define

$$(3.1) \quad \begin{cases} x(r,t) = X(r,t) - A_0, \\ y(r,t) = Y(r,t) - B(r)/A_0. \end{cases}$$

Substituting (3.1) into the reaction-diffusion equations (1.4), we obtain

$$(3.2) \quad \begin{cases} \frac{\partial x}{\partial t} = D_1 \frac{\partial^2 x}{\partial r^2} + (B(r) - 1)x + A_0^2 y + h(x,y) + A(r) - A_0, \\ \frac{\partial y}{\partial t} = D_2 \frac{\partial^2 y}{\partial r^2} - B(r)x - A_0^2 y - h(x,y) + b(r), \end{cases}$$

where $h(x,y)$ reflects the nonlinearity of the problem,

$$(3.3) \quad h(x,y) = B(r)A_0^{-2}x^2 + (2A_0+x)xy,$$

and where

$$(3.4) \quad b(r) = \frac{D_2}{A_0} \frac{d^2 B(r)}{dr^2}.$$

The boundary and initial conditions after substitution read

$$(3.5) \quad x(0,t) = x(1,t) = y(0,t) = y(1,t) = 0, \quad t \geq 0,$$

and

$$(3.6) \quad \begin{cases} x(r,0) = x_0(r) := X_0(r) - A_0, \\ y(r,0) = y_0(r) := Y_0(r) - B(r)/A_0, \quad 0 \leq r \leq 1. \end{cases}$$

After this preparatory work we are able to give a theorem on the existence of a solution of the nonlinear parabolic initial boundary value problem (3.2)-(3.6) in the neighbourhood of $t = 0$, and hence of the original problem.

THEOREM 3.1. *There exists a positive s such that the equations (3.2) have a solution $(x(r,t), y(r,t))$ defined on $(0,1) \times (0,s)$ that obeys the boundary*

conditions (3.5) and the initial conditions (3.6) If the initial data $x_0(r)$ and $y_0(r)$ are infinitely differentiable for $0 < r < 1$, then the solutions $x(r,t)$ and $y(r,t)$ have the same property for $(r,t) \in (0,1) \times (0,s)$.

PROOF. The equations may be written in the form

$$(3.7) \begin{pmatrix} \frac{\partial}{\partial t} - D_1 \frac{\partial^2}{\partial r^2} & 0 \\ 0 & \frac{\partial}{\partial t} - D_2 \frac{\partial^2}{\partial r^2} \end{pmatrix} \begin{pmatrix} x(r,t) \\ y(r,t) \end{pmatrix} = \begin{pmatrix} f_1(r, x(r,t), y(r,t)) \\ f_2(r, x(r,t), y(r,t)) \end{pmatrix},$$

with

$$(3.8) \begin{cases} f_1(r,x,y) = (B(r)-1)x + A_0^2 y + h(x,y) + A(r) - A_0, \\ f_2(r,x,y) = -B(r)x - A_0^2 y - h(x,y) + b(r). \end{cases}$$

There is no essential difference from the situation in which one has only one differential equation. In the same way as in Section II.3, one constructs a Green's function, now having the matrix form

$$G(r,t) = \begin{pmatrix} G_1(r,t) & 0 \\ 0 & G_2(r,t) \end{pmatrix}.$$

Furthermore, it can easily be seen that f_1 and f_2 and the initial conditions $x_0(r)$ and $y_0(r)$ satisfy conditions analogous to those of case (a) of Theorem II.3.4. So, the existence of a distributional solution of the initial boundary value problem on an interval $(0,s)$, for a certain positive s , is guaranteed by a theorem of the same form as Theorem II.3.4 for a system of partial differential equations. From the regularity theory given in Section II.3, particularly Corollary II.3.6, it may be concluded that this solution is a classical one, and also that $x(r,t)$ and $y(r,t)$ are infinitely differentiable. \square

REMARK 3.2. Note that we have only found a solution on an interval $(0,s)$ for a certain positive s . Of course, we wish to prove that there exists a solution for all time. The technique given in Chapter II, however, fails, because our right-hand sides f_1 and f_2 do not satisfy the crucial inequality

$$\sup\{|f(r,u)|, 0 < r < 1, u \in \mathbb{R}\} \leq K(1+|u|),$$

which is the same inequality as (II.3.26), with t and p left out since they do not occur in our case. The existence of a solution for all time is established by a quite different method, as we shall see later on.

4. THE NONNEGATIVITY OF SOLUTIONS

$X(r,t)$ and $Y(r,t)$ are concentrations of chemical components, so from a chemical point of view they have to remain nonnegative. If the mathematical model is to be sensible, we must be able to show mathematically that if the initial concentrations are nonnegative, the solutions also have this property. The proof of this is based on a maximum principle for weakly coupled parabolic systems (see PROTTER & WEINBERGER [8, p.188 ff]). We shall begin this section with a discussion of this version of the maximum principle. The formulation will be adapted to our needs.

Let there be given k parabolic operators defined by

$$(4.1) \quad L_i v = a_i(r,t) \frac{\partial^2 v}{\partial r^2} - \frac{\partial v}{\partial t}, \quad 0 < r < 1, \quad 0 < t < T, \quad 1 \leq i \leq k.$$

Here we assume that the $a_i(r,t)$ are continuous functions, and that

$$(4.2) \quad a_i(r,t) \geq \delta > 0 \quad \text{for all } 0 < r < 1, \quad 0 < t < T, \quad 1 \leq i \leq k.$$

In fact, (4.2) means that the operators L_i are *uniformly parabolic*.

The system of parabolic inequalities for which we need a maximum principle has the form

$$(4.3) \quad L_i u_i + \sum_{j=1}^k h_{ij} u_j \geq 0 \quad i = 1, \dots, k.$$

This system is called *weakly coupled* because it is only coupled by terms which are not differentiated. The elements $h_{ij}(r,t)$ may be arranged in a $k \times k$ -matrix H . We make the additional hypothesis that the off-diagonal elements of H are nonnegative, i.e.

$$(4.4) \quad h_{ij}(r,t) \geq 0, \quad i \neq j, \quad i, j = 1, \dots, k.$$

By the notation $u \leq 0$ it is meant that each component u_i of $u = (u_1, \dots, u_m)$ is nonpositive.

THEOREM 4.1. *Suppose that u satisfies the uniformly parabolic system of inequalities (4.3) in $(0,1) \times (0,T)$. If, moreover, $u \leq 0$ on the boundary of the square $(0,1) \times (0,T)$ with the exception of the top, i.e.*

$$u(r,0) \leq 0, \quad 0 < r < 1,$$

and

$$u(0,t) \leq 0, \quad u(1,t) \leq 0, \quad 0 < t < T,$$

and if the elements h_{ij} satisfy (4.4), then $u \leq 0$ in $[0,1] \times [0,T)$. In addition, if $u_i = 0$ at an interior point (r_0, t_0) , then $u_i(r,t) \equiv 0$ for $t \leq t_0$.

PROOF. See PROTTER & WEINBERGER [8, p.189]. \square

Now consider the semilinear system of parabolic equations

$$(4.5) \quad \frac{\partial u_i}{\partial t} = a_i(r,t) \frac{\partial^2 u_i}{\partial r^2} + c_i(r,t, u_1, \dots, u_k), \quad 1 \leq i \leq k,$$

where again we assume that $0 < r < 1$, $0 < t < T$, that a_i and c_i are continuous, and that the a_i satisfy (4.2). Suppose that the initial values

$$(4.6) \quad u_i(r,0) = u_{0i}(r), \quad 0 < r < 1,$$

are given and that the boundary values

$$(4.7) \quad u_i(0,t) = \alpha_i(t), \quad u_i(1,t) = \beta_i(t),$$

are also prescribed. Finally, we hypothesize that the coefficients c_i are of the form

$$(4.8) \quad c_i(r,t,u) = \sum_{j=1}^k c_{ij}(r,t,u)u_j + c_i(r,t,0),$$

where $u = (u_1, \dots, u_k)$. Then one has the following theorem, taken from AUCHMUTY & NICOLIS [4].

THEOREM 4.2. *Suppose that $u: [0,1] \times [0,T) \rightarrow \mathbb{R}^k$ is a classical solution of (4.5)-(4.8). Assume that the following five conditions are satisfied for all $i, j = 1, \dots, k$, $0 < r < 1$, $0 < t < T$, and all $u \in \mathbb{R}^k$:*

- (i) $u_{0i}(r) \geq 0$;
- (ii) $\alpha_i(t), \beta_i(t) \geq 0$;
- (iii) $c_{ii}(r,t,u) \leq 0$;
- (iv) $c_{ij}(r,t,u) \geq 0$ whenever $i \neq j$;
- (v) $c_i(r,t,0) \geq 0$.

Then $u_i(r,t) \geq 0$ on $[0,1] \times [0,T)$ and for $i = 1, \dots, k$.

PROOF. Let L_i be the operator defined by (4.1). From equation (4.5) and condition (v) one sees that

$$L_i u_i + c_i(r,t,u) - c_i(r,t,0) \leq 0,$$

or

$$L_i u_i + \sum_{j=1}^k c_{ij}(r,t,u)u_j \leq 0.$$

Now it is possible to apply Theorem 4.1, replacing u by $-u$. One gets

$$-u_i(r,t) \leq 0 \quad \text{for all } i, r, t. \quad \square$$

The nonnegativity of the solution of our system is an immediate consequence of this theorem.

THEOREM 4.3. *Suppose that for $0 \leq t < T$, T arbitrary, $(X(r,t), Y(r,t))$ is a solution of the initial boundary value problem for the reaction-diffusion equations given in Section 1, and that the initial conditions $X_0(r)$ and $Y_0(r)$ are nonnegative. Then*

$$X(r,t) \geq 0 \text{ and } Y(r,t) \geq 0 \text{ for } 0 < r < 1, 0 < t < T.$$

PROOF. Apply Theorem 4.2 with $k = 2$ and

$$\begin{aligned} a_i(r,t) &= D_i, \\ c_1(r,t,X,Y) &= A(r) - (B(r)+1)X + X^2Y, \\ c_2(r,t,X,Y) &= B(r)X - X^2Y, \\ \alpha_1(t) &= \beta_1(t) = B_0/A_0 \geq 0, \\ \alpha_2(t) &= \beta_2(t) = A_0 > 0. \end{aligned}$$

It is easily seen that our system has all the required properties. \square

REMARK 4.4. Using Theorem 4.2, one can prove that the parabolic problem (4-5)-(4.7), and hence our reaction-diffusion problem, allow at most one solution.

5. SOME PRELIMINARY REMARKS ON THE EXISTENCE OF A SOLUTION OF THE EVOLUTION EQUATIONS FOR ALL TIME

Until now we have only shown the existence of a solution on an interval $(0,s)$ for a certain positive s , the value of which is determined by the procedure described in Section 3. Since we are, after all, especially interested in stationary solutions, we must convince ourselves that a solution of the evolution equations exists *for all time*. Achieving this conviction will be a rather cumbersome affair. Among others, we shall essentially need the Sobolev space topologies.

We are looking for solutions, for all time, of the parabolic system of equations (3.2). Observe that the nonlinearity of the problem is wholly reflected in the term $h(x,y)$ occurring in both equations. By a simple trick, namely by adding the two equations (3.2), we can locate the nonlinearity of the problem in one of the two equations. Set

$$w(r,t) = x(r,t) + y(r,t);$$

then the equation for w becomes linear. The system of equations we are going to consider is

$$(5.1) \quad \begin{cases} \frac{\partial w}{\partial t} = D_1 \frac{\partial^2 w}{\partial r^2} + (D_2 - D_1) \frac{\partial^2 y}{\partial r^2} - w + y + A(r) - A_0 + b(r), \\ \frac{\partial y}{\partial t} = D_2 \frac{\partial^2 w}{\partial r^2} - B(r)w + (B(r) - A_0^2)y - g(w, y) + b(r), \end{cases}$$

for all $t > 0$, where the nonlinearity term is

$$(5.2) \quad g(w, y) = B(r)A_0^{-1}(w-y)^2 + (w-y+A_0)^2y - A_0^2y.$$

To save ourselves the trouble of too lengthy formulas, we shall write (5.1) in the form

$$(5.3) \quad \begin{cases} \frac{\partial w}{\partial t} = D_1 \frac{\partial^2 w}{\partial r^2} + (D_2 - D_1) \frac{\partial^2 y}{\partial r^2} + F(w, y) + a(r), \\ \frac{\partial y}{\partial t} = D_2 \frac{\partial^2 w}{\partial r^2} + G(w, y) + b(r), \quad 0 < r < 1, \quad 0 < t < \infty, \end{cases}$$

where F is the linear expression

$$(5.4) \quad F(w, y) = -w + y,$$

G the nonlinear expression

$$(5.5) \quad G(w, y) = -B(r)w + (B(r) - A_0^2)y - g(w, y),$$

and

$$(5.6) \quad a(r) = A(r) - A_0 + b(r).$$

Observe that G is a polynomial of the third degree in w and y , with coefficients depending on r that are infinitely differentiable with respect to r .

The boundary and initial conditions for w follow from those for x and y . For the sake of easy reference, we give them all here:

$$(5.7) \quad w(0, t) = w(1, t) = y(0, t) = y(1, t) = 0, \quad 0 < t < \infty,$$

$$(5.8) \quad \begin{cases} w(r,0) = w_0(r) := x_0(r) + y_0(r), \\ y(r,0) = y_0(r), \quad 0 < r < 1. \end{cases}$$

As noted before, we are only interested in nonnegative solutions $X(r,t)$ and $Y(r,t)$. Translating this requirement in terms of the new dependent variables $w(r,t)$ and $y(r,t)$, we find that w and y must satisfy

$$(5.9) \quad \begin{cases} w(r,t) \geq -A_0 + y(r,t), \\ y(r,t) \geq -B(r)/A_0, \quad 0 < r < 1. \end{cases}$$

From Theorem 4.3 we know that any classical solution of our problem will satisfy (5.9) provided that the initial conditions fulfil

$$(5.10) \quad w_0(r) \geq -A_0 + y_0(r), \quad y_0(r) \geq -B(r)/A_0, \quad 0 < r < 1.$$

Our aim is to establish the existence of a solution of the problem (5.3)-(5.10) for all time. When we have done so, we also, of course, have the existence of a solution for all time of the original problem in X and Y .

The main difficulty in proving that the solutions X and Y guaranteed by Theorem 3.1 on an interval $(0,s)$ for some s can be continued for all time is to show that they do not blow up. The reason why this question is interesting is that the chemical model (1.1) does not allow us to conclude beforehand that the concentrations X and Y remain bounded, since there is an unlimited amount of A and B . Of course, if the solutions of our reaction-diffusion equations were to explode, the model we are discussing in this chapter would not make any sense at all.

So we must find, by mathematical means, an upper bound for a solution of (1.4), (1.5), (1.7)-(1.9), (1.11), (1.12), or equivalently of (5.3)-(5.10), without actually having a solution. Such upper bounds are called *a priori estimates*. One might expect to find the upper bounds for the solution in more or less the same way as the lower bounds (Theorem 4.3) were found, that is by means of a maximum principle for weakly coupled parabolic systems. The key to this approach would be a theorem by WEINBERGER [23, p.299] which states that if the initial and boundary conditions of the

parabolic problem remain in a convex set S of the (w,y) -plane, and if the vector consisting of the non-differential terms never points outward on the boundary of S , then the solution will remain in S for all $0 < r < 1$ and $t > 0$. Unfortunately, one is not capable of finding such a set S with $(F(w,y)+a(r), G(w,y)+b(r))$ never pointing outward. Therefore, the maximum principle attempt of finding upper bounds for the solution collapses. One is, however, able to find such a priori estimates for so-called *weak solutions* of the problem, or in other words in a Sobolev space topology setting.

The problem we have to solve combines certain features of the Cauchy problem with features borrowed from elliptic boundary value problems. The solutions $w(r,t)$, $y(r,t)$ are defined on the Cartesian product of a space and a time interval. In the space coordinate the equations are elliptic. For elliptic partial differential equations there is a well-known Sobolev space theory, so it pays to regard the functions w and y of two variables,

$$\begin{aligned} w,y: (0,1) \times (0,T) &\rightarrow \mathbb{R} \\ (r,t) &\mapsto w, y(r,t), \end{aligned}$$

as functions of one variable, t , with values in a space E of functions of the variable r , i.e.

$$\begin{aligned} w,y: (0,T) &\rightarrow E \\ t &\mapsto w, y[t]. \end{aligned}$$

When doing so, we shall write $w[t](r)$ instead of $w(r,t)$. Usually E will be one of the Sobolev spaces, e.g. $H_0^1(0,1)$.

The advantage of this approach is the following. In a certain sense we separate the variables. The solutions w and y , as functions of r , satisfy certain boundary conditions. In Sobolev space theory for elliptic equations, it is customary to express the fact that a function is to satisfy certain homogeneous boundary conditions by requiring that it must be an element of a certain Sobolev space. Below, rudiments of this theory, as far as we need

it, are given. Imposing an initial condition on w, y calls for taking w, y as functions of t . In the above notation, this comes down to a condition that $w[t] \rightarrow w_0, y[t] \rightarrow y_0$ in a certain sense as $t \downarrow 0$, $w[t]$ and $y[t]$ belonging to certain Sobolev spaces for all t .

The drawback of this approach is apparent. The reader needs some acquaintance with functions that have their ranges in an infinite-dimensional linear space. The next section is concerned with this.

6. FUNCTIONS VALUED IN A BANACH SPACE

The purpose of this section is to provide the minimum number of facts necessary about functions valued in a Banach space E . In view of our needs, we merely need a straightforward generalization of the scalar case. Our exposition here has a more psychological than mathematical meaning: we hope to convince the reader that the difference between functions valued in a Banach (or Hilbert) space and those valued in \mathbb{R} (or \mathbb{C}) is easy to overcome, and that both kinds of functions obey the same set of rules.

In Chapter II the definition of Sobolev spaces was given. Here we shall only need the spaces $H^{m,2}(0,1) = H^m(0,1)$ of functions $f(r)$ defined on $0 < r < 1$. Furthermore, we are only interested in real-valued functions, or in functions valued in a Sobolev space over the real scalar field. Consequently, we leave out the bar in the definition of the inner product in $H^m(0,1)$:

$$(f, g)_m = \sum_{k \leq m} \int_0^1 \frac{d^k f}{dr^k} \frac{d^k g}{dr^k} dr.$$

Recall (see Section II.2) that $H_0^m(0,1)$ is the completion of $C_0^\infty(0,1)$ in $H^m(0,1)$, that $C_0^\infty(0,1)$ is dense in $L^2(0,1)$, and that $H_0^m(0,1)$ is a proper subspace of $H^m(0,1)$ when $m \geq 1$.

THEOREM 6.1. *The imbedding*

$$I: H^1(0,1) \rightarrow L^2(0,1)$$

is compact.

PROOF. This is a special case of Theorem II.2.3., with $n = 1$, $p = 2$ and $m = 1$. \square

The following special case of Sobolev's imbedding theorem is needed.

THEOREM 6.2. (Sobolev). *The identity mapping*

$$I : H^1(0,1) \rightarrow C^{0+\alpha}[0,1], \quad 0 < \alpha < \frac{1}{2},$$

is compact (which implies that I is continuous).

PROOF. This is a special case of Theorem II.2.4. \square

LEMMA 6.3. *If $f \in H_0^1(0,1)$, then $f(0) = f(1) = 0$.*

PROOF. From the preceding theorem we see that u may be changed on a set of measure zero such that it is a continuous function on $[0,1]$, so it makes sense to write $f(0)$ and $f(1)$. For the rest of the proof see AGMON [9, p.105]. \square

LEMMA 6.4. *The Sobolev spaces $H^m(0,1)$ are separable, i.e. they admit a countably infinite set that is dense in $H^m(0,1)$.*

PROOF. See NECAS [10, p.64]. A different way to state this property is to say that $H^m(0,1)$ has a countably infinite base. \square

DEFINITIONS 6.5. Let

$$\begin{aligned} f: (0,T) &\rightarrow E \\ t &\mapsto f[t], \end{aligned}$$

where E is a Banach space. Since E is equipped with a norm, it is obvious what is meant by such a function being *continuous at some point* $t \in (0,T)$ or in a subset of $(0,T)$. The definition of the *derivative of f at t* is equally obvious: it means that the limit

$$\lim_{h \rightarrow 0} \frac{f[t+h] - f[t]}{h}$$

exists ($h \neq 0$, small and real). Observe that this definition fully exploits the fact that E is a normed linear space: besides convergence, vector subtraction and scalar multiplication of vectors are also used. The derivative at t is denoted by $df(t)/dt$ or $f'(t)$. If it exists at all points of $(0, T)$, we say that f is differentiable on $(0, T)$. Those familiar with Fréchet derivatives of a mapping (see e.g. TEMME [11]) will see that both notions coincide.

The definitions of higher order differentiability and of continuous differentiability are obvious.

NOTATION 6.6. In analogy to the space of continuous real-valued functions on $[0, T]$ we introduce the notation $C^0([0, T]; E)$ for the linear space of continuous E -valued functions. Of course, $C^0([0, T]; \mathbb{R}) = C^0[0, T]$. The norm in $C^0([0, T]; E)$ is defined as

$$(6.1) \quad \|f\|_{C^0([0, T]; E)} = \max_{0 \leq t \leq T} \|f[t]\|_E.$$

The reader will understand the meaning of $C^m([0, T]; E)$, $1 \leq m \leq \infty$, without further explanation.

DEFINITION 6.7. Integration of functions valued in E is also easily defined. The definition of the *Riemann integral* is immediate: $\int_0^T f[t] dt$ is the limit in E of the Riemann sums

$$\sum_{0 < t_1 < \dots < t_n < T} f[t'_j](t_{j+1} - t_j),$$

which converge, for instance, for continuous f because E is a complete space. Likewise, one can define *Lebesgue integration* of a function $f: (0, T) \rightarrow E$.

The Lebesgue spaces $L^2(0, T; E)$ are defined as the completion of the linear space of infinitely differentiable E -valued functions with compact support, $C_0^\infty(0, T; E)$, with respect to the norm

$$(6.2) \quad \|f\|_{L^2(0,T;E)} = \left(\int_0^T \|f[t]\|_E^2 dt \right)^{\frac{1}{2}}.$$

The trouble with this definition is in the first instance that the elements of this space are "ideal objects". Without proof (see e.g. TREVES [12, p.383]) we mention that by means of the Lebesgue integration theory the elements of $L^2(0,T;E)$ can be recognized as classes of functions modulo the standard equivalence relation of being equal almost everywhere, which here amounts to $u \sim v$ iff

$$\int_0^T \|f[t] - g[t]\|_E^2 dt = 0.$$

REMARK 6.8. One should be on one's guard: the space $L^2(0,T;E)$ is, with respect to the norm (6.2), a Banach space, but in general (that is, unless E is itself a Hilbert space) $L^2(0,T;E)$ is not a Hilbert space. In the case that E is a Hilbert space, $L^2(0,T;E)$ is equipped with the canonical Hilbert space structure by the inner product

$$(6.3) \quad (f,g)_{L^2(0,T;E)} = \int_0^T (f[t], g[t])_E dt.$$

REMARK 6.9. In the following sections the spaces $L^2(0,T;H_0^1(0,1))$ and $L^2(0,T;L^2(0,1))$ are often used.

Let $f(x,t)$ map $(0,1) \times (0,T)$ into \mathbb{R} , and denote $t \mapsto f(\cdot, t)$ by $f[\cdot]$. Then if $f \in L^2(0,T;L^2(0,1))$, it can be regarded as a function belonging to $L^2((0,1) \times (0,T))$. In short we write, not quite accurately, $L^2(0,T;L^2(0,1)) = L^2((0,1) \times (0,T))$.

Our final definition in this section concerns Sobolev spaces of functions valued in a Banach space E . It does not surprise us that this definition is straightforward too.

We recall that the distributional derivative of a locally integrable function $f: (0,T) \rightarrow \mathbb{R}$, usually also denoted by df/dt , or, Df is defined by the relation

$$\int_0^T \frac{df(t)}{dt} \phi(t) dt = - \int_0^T f(t) \frac{d\phi(t)}{dt} dt$$

for all C^∞ -functions $\phi: (0,T) \rightarrow \mathbb{R}$ with compact support in \mathbb{R} . Likewise, the distributional derivative of an E -valued function $u: (0,T) \rightarrow E$ is defined by the relation

$$(6.4) \quad \int_0^T \frac{df[t]}{dt} \phi(t) dt = - \int_0^T f[t] \frac{d\phi(t)}{dt} dt$$

for all $\phi \in C_0^\infty(0,T)$. Higher order derivatives are defined by repetition of (6.4).

DEFINITION 6.10. The m -th Sobolev space of E -valued functions $H^m(0,T;E)$ is defined as the linear space of all E -valued functions of which the m -th order distributional derivatives belong to $L^2(0,T;E)$. If E is a Hilbert space, this linear space becomes a Hilbert space under the canonical Hilbert space structure

$$(6.5) \quad (f,g)_{H^m(0,T;E)} = \sum_{k=0}^m \int_0^T \left(\frac{d^k f[t]}{dt^k}, \frac{d^k g[t]}{dt^k} \right)_E dt.$$

We conclude this section by stating the following theorem, which is a special case of possible Sobolev theorems for E -valued functions (we do not need other theorems).

THEOREM 6.11. If $f \in L^2(0,T;E)$ and $\frac{df}{dt} \in L^2(0,T;E)$, then, after possible modification on a set of measure zero contained in $[0,T]$, f is a continuous function of $[0,T]$ into E . In agreement with former notation one usually writes this fact less precisely in the form

$$(6.6) \quad H^1(0,T;E) \subset C^0([0,T];E).$$

The identity map defined by (6.6) is continuous (even compact).

PROOF. There is no real difference between the proof of this theorem and that of Theorem 6.2. \square

7. THE FAEDO-GALERKIN METHOD

Having summarized some rather elementary theory on functions valued in Banach spaces, we are now in a position to introduce the concept of a weak solution of the initial boundary value problem for the evolution equations (5.3). We first introduce some notation.

NOTATION 7.1. In the following, the set $Q \subset \mathbb{R}^2$ will be the set

$$Q = (0,1) \times (0,T).$$

The functions $w(r,t)$ and $y(r,t)$ will be regarded as functions $w[t]$ and $y[t]$ with values in an appropriate Sobolev space. So,

$$w[t](r) = w(r,t), \quad y[t](r) = y(r,t).$$

Furthermore, let $\phi(r)$ and $\psi(r)$ be weakly differentiable functions on $0 < r < 1$ with zero values in $r = 0$ and $r = 1$. More precisely, let ϕ and ψ belong to the function space $H_0^1(0,1)$. Then the *Dirichlet integral* $D(\phi,\psi)$ is defined as

$$(7.1) \quad D(\phi,\psi) = \int_0^1 \frac{d}{dr} \phi(r) \frac{d}{dr} \psi(r) dr.$$

Remember that we are only considering Sobolev spaces over the real scalar field, since $w(r,t)$ and $y(r,t)$ are also supposed to be real. For ϕ and $\psi \in C_0^\infty(0,1)$, the Dirichlet integral is equal to

$$D(\phi,\psi) = - \int_0^1 \frac{d^2 \phi(r)}{dr^2} \psi(r) dr,$$

as is seen by partial integration.

Observe also that the two-fold differentiation with respect to r is bounded when regarded as an operator

$$\Delta = \frac{\partial^2}{\partial r^2} : H^2(0,1) \rightarrow L^2(0,1).$$

In our definition of weak solution we shall not make use of the specific form of $w_0(r)$ and $y_0(r)$, in order that the general idea of the Faedo-Galerkin method, which is applicable to many other equations, is not obscured.

DEFINITION 7.2. Let $0 < T \leq \infty$ be arbitrarily chosen. Let the initial data w_0 and y_0 satisfy

$$(7.2) \quad w_0, y_0 \in H_0^1(0,1) \cap H^2(0,1),$$

(which is, in fact, a little more restrictive than (5.8); compare also (3.6)). Assume further that

$$a, b \in H^1(0,1),$$

which is less restrictive than (1.9). Then a *weak solution* on $(0, T)$ of the initial boundary value problem for the evolution equations (5.3) is defined as a pair of functions (w, y) , with

$$(7.3) \quad w, y \in L^2(0, T; H_0^1(0,1) \cap H^2(0,1)),$$

satisfying the equations (writing $w[t](r) = w(r, t)$ etc.)

$$(7.4) \quad \begin{cases} \frac{d}{dt}(w[t], \phi)_0 = D_1(\Delta w[t], \phi)_0 + (D_2 - D_1)(\Delta y[t], \phi)_0 \\ \quad + (F(w[t], y[t]), \phi)_0 + (a, \phi)_0, \\ \frac{d}{dt}(y[t], \phi)_0 = D_2(\Delta y[t], \phi)_0 + (G(w[t], y[t]), \phi)_0 \\ \quad + (b, \phi)_0, \end{cases}$$

for $0 < t < T$ and for all $\phi \in H_0^1(0,1) \cap H^2(0,1)$, the initial conditions

$$(7.5) \quad \begin{cases} \|w[t] - w_0\|_1 \rightarrow 0 \\ \|y[t] - y_0\|_1 \rightarrow 0 \end{cases} \quad \text{as } t \downarrow 0;$$

and the conditions

$$(7.6) \quad y(r,t) \geq B(r)/A_0, \quad w(r,t) \geq -A_0 + y(r,t)$$

for $0 < r < 1$, $0 < t < T$, which ascertain the nonnegativity of $X(r,t)$ and $Y(r,t)$. Remember that $C^0[0,1] \subset H^1(0,1)$, so that (7.6) makes sense.

REMARK 7.3. The reader may wonder if in this definition the boundary conditions $w(0,t) = w(1,t) = y(0,t) = y(1,t) = 0$ are forgotten. This is not so, since from (7.3) there follows

$$w[t], y[t] \in H_0^1(0,1) \quad \text{for almost all } t \in (0,T),$$

so by Lemma 6.3 one has $w[t](0) = w[t](1) = 0$, and the same for $y[t]$, for $0 < t < T$ almost everywhere.

The initial condition (7.5) may seem meaningless at first sight. Later on we shall prove that the derivatives of the weak solution $\frac{d}{dt}w[t]$ and $\frac{d}{dt}y[t]$ belong to $L^2(0,T;L^2(0,1))$, so that from Theorem 6.11 one may conclude that $w[t]$ and $y[t]$ are continuous functions of $[0,T]$ into $L^2(0,1)$.

Our aim is to solve the weak problem (7.2)-(7.6) by the so-called *Faedo-Galerkin method*. Let us first make some introductory remarks.

Physicists and engineers, confronted with boundary value problems for elliptic partial differential equations, were led to devise practical methods for approximating the solutions of such problems. Much in favour recently is the *Galerkin method*, which is based on the approximation of the elliptic partial differential equation by linear equations in finite-dimensional subspaces of the infinite-dimensional function space in which we are looking for a solution. One solves these finite-dimensional systems of linear equations, and then shows that their solutions converge to that of the original boundary value problem as the finite-dimensional spaces suitably increase to the full space.

FAEDO [13] constructed a method to prove the existence of a solution of initial boundary value problems for linear parabolic differential equations, which is based on the Galerkin method described above. With respect to the space variables, one proceeds in exactly the same fashion as in the Galerkin method, but instead of obtaining a finite system of linear equations one here has to deal with a finite system of linear ordinary differential equa-

tions, which one solves by means of the standard theory for such equations. Finally, one then has to show that the solutions of these finite-dimensional systems approach the solution of the original initial boundary value problem, the latter being considered as an initial value problem for ordinary differential equations in an infinite-dimensional function space, as the finite-dimensional subspaces of functions in the space variables increase in a suitable manner.

This method, usually called the Faedo-Galerkin method, was first applied to a nonlinear problem by HOPF [14]. He showed the fundamental role this method plays when discussing the Navier-Stokes equation. In his book [5], LIONS gives many examples of how this method and similar ones can be used to prove the existence of solutions of initial boundary value problems for nonlinear evolution equations.

Since the Faedo-Galerkin method is useful in a variety of nonlinear evolution problems, it is worthwhile to give it detailed attention. Luckily, the problem we have at hand is such that all the characteristic features of the method show up when discussing its application to our problem.

All the applications of the Faedo-Galerkin method to nonlinear problems have in common that the passage to the limit from finite systems of differential equations to differential equations in an infinite-dimensional vector space, as mentioned above, is far more tedious to establish than it is in the linear case. It is here that the necessity for a priori bounds for the solution of the original problem, already announced in Section 5, becomes apparent.

Our argument is arranged in the following manner.

- (i) This section is concluded by the construction of approximate solutions of (7.2)-(7.6).
- (ii) In the next section we derive the necessary a priori estimates.
- (iii) Then, in Section 9, we actually perform the passage to the limit.

Let $\{\phi_j\}$, $j = 1, 2, \dots$, be a sequence of elements of $H_0^1(0,1) \cap H^2(0,1)$ that is dense in this space. Notice that the ϕ_j are chosen to be independent of t . Such a sequence exists, because according to Lemma 6.4 $H^m(0,1)$ is a separable space. In our case it pays to choose the ϕ_j to be the solutions of the eigenvalue problem

$$(7.7) \quad \begin{cases} -\Delta\phi_j = \lambda_j \phi_j & (\text{i.e. } -\phi_j''(x) = \lambda_j \phi_j(x), 0 < x < 1), \\ \phi_j \in H_0^1(0,1) \cap H^2(0,1) & (\text{so } \phi(0) = \phi(1) = 0). \end{cases}$$

These functions form an orthonormal base in $L^2(0,1)$. The initial data w_0 and y_0 can now be approximated by a linear combination of $\{\phi_j\}$. Write

$$(7.8) \quad \begin{cases} w_{0m} = \sum_{i=1}^m \alpha_{0m}^i \phi_i \rightarrow w_0 \\ y_{0m} = \sum_{i=1}^m \beta_{0m}^i \phi_i \rightarrow y_0 \end{cases} \quad \text{in } H_0^1(0,1) \cap H^2(0,1) \text{ as } m \rightarrow \infty.$$

We choose the coefficients α_{0m}^j and β_{0m}^j in such a manner that

$$(7.9) \quad y_{0m}(x) \geq B(x)/A_0, \quad w_{0m}(x) \geq -A_0 + y_{0m}(x).$$

We now seek approximate solutions w_m and y_m of (7.2)-(7.6) in the form

$$(7.10) \quad \begin{cases} w_m[t] = \sum_{i=1}^m \alpha_m^i(t) \phi_i, \\ y_m[t] = \sum_{i=1}^m \beta_m^i(t) \phi_i. \end{cases}$$

Hence, $w_m[t]$ and $y_m[t]$ belong to the linear span of ϕ_1, \dots, ϕ_m . Substituting these expressions into the equation (7.4), and noting that here it is sufficient to let the ϕ in (7.4) range only over the set $\{\phi_j \mid j = 1, \dots, m\}$, we obtain the following system of $2m$ (nonlinear) differential equations for the coefficients $\alpha_m^j(t)$ and $\beta_m^j(t)$:

$$(7.11) \quad \begin{cases} \frac{d}{dt} \alpha_m^j(t) = \frac{d}{dt} (w_m[t], \phi_j)_0 \\ \quad = D_1 (\Delta w_m[t], \phi_j)_0 + (D_2 - D_1) (\Delta y_m[t], \phi_j)_0 \\ \quad \quad + (F(w_m[t], y_m[t]), \phi_j)_0 + (a, \phi_j)_0 \\ \frac{d}{dt} \beta_m^j(t) = \frac{d}{dt} (y_m[t], \phi_j)_0 \\ \quad = D_2 (\Delta y_m[t], \phi_j)_0 + (G(w_m[t], y_m[t]), \phi_j)_0 \\ \quad \quad + (b, \phi_j)_0, \quad j = 1, \dots, m, \quad 0 < t < T. \end{cases}$$

From (7.8) and (7.10) it follows that $\alpha_m^j(t)$ and $\beta_m^j(t)$ satisfy the initial conditions

$$(7.12) \quad \alpha_m^j(0) = \alpha_{0m}^j, \quad \beta_m^j(0) = \beta_{0m}^j, \quad j = 1, \dots, m.$$

The equations (7.11) have uniquely determined solutions $\alpha_m^j(t)$ and $\beta_m^j(t)$, $j = 1, \dots, m$, obeying the initial conditions (7.12), defined on a certain interval $(0, t_m)$. This is a consequence of the following standard existence theorem in the theory of ordinary differential equations. Later on it will be proved that $t_m = T$ for all m .

THEOREM 7.4. *Let Ω be an open set of \mathbb{R}^{n+1} , the elements of which are written as (t, x) with $t \in \mathbb{R}$ and $x \in \mathbb{R}^n$. Let $f: \Omega \rightarrow \mathbb{R}^n$, $(t, x) \mapsto f(t, x)$ be a continuous function in D that is Lipschitz continuous with respect to the variable x in D . Then for any $(t_0, x_0) \in D$ the system of ordinary differential equations*

$$(7.13) \quad \frac{dx(t)}{dt} = f(t, x)$$

has a unique continuously differentiable solution passing through (t_0, x_0) (i.e. $x(t_0) = x_0$); this solution is defined on an open interval $I \subset \Omega$ with $t_0 \in I$.

PROOF. See HALE [15, p.18 ff]. \square

It is easily seen that the right-hand sides of (7.11) satisfy the conditions of the theorem, taking, of course, $n = 2m$.

It is hoped that the reader has noticed that in a certain sense we have "separated variables"; in the functions ϕ_j the space variable r is hidden, whereas they are independent of the time t .

Having found uniquely determined solutions $\alpha_m^j(t)$ and $\beta_m^j(t)$ of (7.11) and (7.12) we have achieved the construction of approximate solutions $w_m[t]$ and $y_m[t]$; this is seen by simply inspecting (7.10), from which it also follows that w_m and y_m belong to $C^1(0, t_m; H_0^1(0, 1) \cap H^2(0, 1))$.

REMARK 7.5. Because w_m and y_m satisfy equations (5.3), and because their initial values obey the nonnegativity requirements (5.10), Theorem 4.3 shows

that w_m and y_m satisfy the nonnegativity requirements for all $t \in [0, t_m)$.

8. A PRIORI ESTIMATES FOR WEAK SOLUTIONS OF THE EVOLUTION EQUATIONS

This section has a rather technical nature. The reader who wishes to keep an eye on the main line of the argument, and does not wish to go into all the technical details, is advised to take notice of the results in this section, without looking at the proofs, and then proceed to Section 9.

Theorem 8.4 gives the crucial estimates. First, however, we derive some elementary inequalities.

LEMMA 8.1. *For all $\phi \in H_0^1(0,1)$ the Dirichlet integral satisfies, for certain positive constants c_1 and c_2 ,*

$$(8.1) \quad c_1 \|\phi\|_1^2 \leq D(\phi, \phi) \leq c_2 \|\phi\|_1^2.$$

PROOF. Since

$$\phi(r) = \int_0^r \phi'(s) ds = \int_0^r \phi'(s) \cdot 1 ds,$$

application of the Cauchy-Schwarz inequality yields

$$\phi^2(r) \leq \int_0^r (\phi'(s))^2 ds \leq \|\phi'\|_0^2.$$

Integration of this result with respect to r gives

$$\int_0^1 \phi^2(r) dr = \|\phi\|_0^2 \leq \|\phi'\|_0^2 = D(\phi, \phi),$$

which is usually called the *Poincaré inequality*. Hence

$$\|\phi\|_1^2 = \|\phi\|_0^2 + \|\phi'\|_0^2 \leq 2\|\phi'\|_0^2 = 2D(\phi, \phi).$$

The other inequality is trivial. \square

REMARK 8.2. The consequence of this lemma is that $(D(\phi, \phi))^{\frac{1}{2}}$ is a norm on $H_0^1(0,1)$ equivalent to the original norm $\|\phi\|_1$.

LEMMA 8.3. For all $\phi \in H_0^1(0,1) \cap H^2(0,1)$ the following inequality holds:

$$(8.2) \quad \|\phi\|_2 \leq \text{const.} \|\Delta\phi\|.$$

PROOF. It is possible to prove this in an elementary way. The result also follows from Theorem III.2.10. \square

THEOREM 8.4. Suppose that w_m and y_m are (weak) solutions of (7.9)-(7.12) for all t . Then there exist positive constants α, β and constants c_1, c_2 and c_3 such that

$$(8.3) \quad \frac{1}{2} \frac{d}{dt} (\alpha \|w_m[t]\|_1^2 + \beta \|y_m[t]\|_1^2) \leq c_1 \|w_m[t]\|_1^2 + c_2 \|y_m[t]\|_1^2 + c_3$$

for all $m = 1, 2, \dots$ and all t .

PROOF. Because of the special choice of our base $\{\phi_j\}$ we may substitute $-\lambda_j^{-1} \Delta \phi_j$ for ϕ_j in (7.11); multiply each of the first m equations by $\alpha_m^j(t)$, each of the second m equations by $\beta_m^j(t)$, and take the sum over j from 1 until m . One then gets

$$(8.4) \quad \begin{cases} \frac{d}{dt} (w_m[t], -\Delta w_m[t])_0 = -D_1 \|\Delta w_m[t]\|_0^2 - (D_2 - D_1) (\Delta w_m[t], \Delta y_m[t])_0 \\ \quad + (F(w_m[t], y_m[t]), -\Delta w_m[t])_0 + (a, -\Delta w_m[t])_0 \\ \frac{d}{dt} (y_m[t], -\Delta y_m[t])_0 = -D_2 \|\Delta y_m[t]\|_0^2 \\ \quad + (G(w_m[t], y_m[t]), -\Delta y_m[t])_0 + (b, -\Delta y_m[t])_0. \end{cases}$$

Using the equivalence of the norms $(D(u, u))^{\frac{1}{2}}$ and $\|u\|_1$ for $H_0^1(0,1)$, we obtain

$$\begin{aligned} & \frac{1}{2} \frac{d}{dt} (\alpha \|w_m[t]\|_1^2 + \beta \|y_m[t]\|_1^2) \\ & \leq -\alpha D_1 \|\Delta w_m[t]\|_0^2 - \alpha (D_2 - D_2) (\Delta w_m[t], \Delta y_m[t])_0 \\ & \quad - \beta D_2 \|\Delta y_m[t]\|_0^2 \\ & \quad + \alpha D (F(w_m[t], y_m[t]), w_m[t]) + \beta D (G(w_m[t], y_m[t]), y_m[t]) \\ & \quad + \alpha D (a, w_m[t]) + \beta D (b, y_m[t]). \end{aligned}$$

In the rest of this proof we shall drop the index m and the argument t ; so we write $w_m[t](r) = w_m(r, t) = w$, etc. Using the Cauchy-Schwarz inequality a few times, we find

$$D(a, w) \leq \left| \int_0^1 \frac{\partial a}{\partial r} \frac{\partial w}{\partial r} dr \right| \leq \|a\|_1 \|w\|_1,$$

$$D(b, y) \leq \|b\|_1 \|y\|_1$$

and, in view of (5.4)

$$(8.5) \quad D(F(w, y), w) \leq \left| \int_0^1 \frac{\partial}{\partial r}(-w+y) \frac{\partial w}{\partial r} dr \right| \leq$$

$$\| -w+y \|_1 \|w\|_1 \leq (\|w\|_1 + \|y\|_1) \|w\|_1.$$

Of course, it takes more trouble to find an estimate for the nonlinear term $D(G(w, y), y)$. By definition, see (5.5) and (5.2)

$$G(w, y) = -B(w-y) - BA_0^{-1}(w-y)^2 - (w-y+A_0)^2 y,$$

so

$$(8.6) \quad \int_0^1 \frac{\partial G(w, y)}{\partial r} \frac{\partial y}{\partial r} dr = \int_0^1 \frac{\partial y}{\partial r} \left[- (w-y) \frac{dB}{dr} - B \frac{\partial}{\partial r}(w-y) \right.$$

$$\left. - A_0^{-1} (w-y)^2 \frac{dB}{dr} - 2BA_0^{-1} (w-y) \frac{\partial}{\partial r}(w-y) \right.$$

$$\left. - (w-y+A_0)^2 \frac{\partial y}{\partial r} - 2(w-y+A_0)y \frac{\partial}{\partial r}(w-y) \right] dr$$

$$= I_1 + I_2 + I_3 + I_4 + I_5 + I_6.$$

Using the additional condition (7.9) on the initial values of y and recalling Remark 7.5, we find that $y \geq -BA_0^{-1}$, so

$$I_4 + I_6 \leq \int_0^1 2B \frac{\partial}{\partial r}(w-y) \frac{\partial y}{\partial r} dr.$$

The second additional condition (7.9) implies that $w - y \geq -A_0$, which provides an upper bound for I_3 :

$$I_3 \leq \int_0^1 (w-y) \frac{dB}{dr} \frac{\partial y}{\partial r} dr.$$

Obviously, $I_5 \leq 0$. Making use of these three estimates, and applying the Cauchy-Schwarz inequality a number of times, we obtain

$$\begin{aligned} \left| \int_0^1 \frac{\partial G}{\partial r} \frac{\partial y}{\partial r} dr \right| &\leq \left| \int_0^1 \frac{\partial y}{\partial r} \left[- (w-y) \frac{dB}{dr} - B \frac{\partial}{\partial r} (w-y) \right. \right. \\ &\quad \left. \left. + (w-y) \frac{dB}{dr} + 2B \frac{\partial}{\partial r} (w-y) \right] dr \right| \\ &\leq M \|y\|_1 (\|w\|_1 + \|y\|_1), \end{aligned}$$

where M is a constant depending on the maxima of B and dB/dr . Finally,

$$\begin{aligned} &-\alpha D_1 \|\Delta w\|_0^2 - \alpha (D_2 - D_1) (\Delta w, \Delta y)_0 - \beta D_2 \|\Delta y\|_0^2 \\ (8.7) \quad &= -\alpha D_1 \left[\|\Delta w - \frac{1}{2}(\gamma-1)\Delta y\|_0^2 + \left(\frac{\beta\gamma}{\alpha} - \frac{1}{4}(\gamma-1)^2 \right) \|\Delta y\|_0^2 \right], \end{aligned}$$

where $\gamma = D_2/D_1$. Choose α and $\beta > 0$ such that

$$(8.8) \quad \alpha D_1 \left(\frac{\beta\gamma}{\alpha} - \frac{1}{4}(\gamma-1)^2 \right) := \varepsilon > 0.$$

Then the left hand side of (8.7) is $\leq -\varepsilon \|\Delta y\|_0^2$. Combining all the estimates obtained above, we find that there exist constants k_1, k_2, k_3 and k_4 , such that

$$\begin{aligned} &\frac{1}{2} \frac{d}{dt} (\alpha \|w\|_1^2 + \beta \|y\|_1^2) + \varepsilon \|\Delta y\|_0^2 \leq \\ (8.9) \quad &\leq k_1 \|w\|_1^2 + k_2 \|y\|_1^2 + k_3 \|w\|_1 + k_4 \|y\|_1 \end{aligned}$$

when α and β are chosen to satisfy (8.8). Hence (8.3) holds. \square

COROLLARY 8.5. Under the assumptions on w_m and y_m made above, there exist constants K , K_0 and μ such that

$$(8.10) \quad \begin{cases} \|w_m[t]\|_1^2 \leq Ke^{\mu t} + K_0, \\ \|y_m[t]\|_1^2 \leq Ke^{\mu t} + K_0, \end{cases}$$

for all t and m .

PROOF. Let $u(t) = \alpha \|w_m[t]\|_1^2 + \beta \|y_m[t]\|_1^2$ with α and β satisfying (8.8). Then the estimate (8.3) may be written as

$$\frac{du(t)}{dt} \leq \mu u(t) + c_3$$

with $u(0) = \alpha \|w_m[0]\|_1^2 + \beta \|y_m[0]\|_1^2$.

Integration of the differential inequality yields

$$u(t) \leq \frac{c_3}{\mu}(e^{\mu t} - 1) + u(0)e^{\mu t}.$$

Together with (7.8) this implies (8.10). \square

COROLLARY 8.6. Under the same assumptions on w_m and y_m , there exists a non-negative constant c , only depending on T , such that

$$\int_0^T \|w_m[t]\|_2^2 dt \leq c(T)$$

and

$$\int_0^T \|y_m[t]\|_2^2 dt \leq c(T)$$

for all m .

PROOF. Inspecting the proof of Theorem 8.4 carefully, taking special notice of inequality (8.9), we see that instead of (8.3) we could just as well have proved

$$\begin{aligned} \frac{1}{2} \frac{d}{dt} (\alpha \|w_m[t]\|_1^2 + \beta \|y_m[t]\|_1^2) + \varepsilon \|\Delta y_m[t]\|_0^2 \\ \leq c_1 \|w_m[t]\|_1^2 + c_2 \|y_m[t]\|_1^2 + c_3, \end{aligned}$$

valid for all t and m . Integrating this from 0 to T , one obtains

$$\begin{aligned} \varepsilon \int_0^T \|\Delta y_m[t]\|_0^2 dt &\leq c_1 \int_0^T \|w_m[t]\|_1^2 dt \\ &+ c_2 \int_0^T \|y_m[t]\|_2^2 dt + c_3 T \\ &- \frac{1}{2} \{ \alpha (\|w_m[T]\|_1^2 - \|w_m[0]\|_1^2) + \beta (\|y_m[T]\|_1^2 - \|y_m[0]\|_1^2) \}. \end{aligned}$$

Application of (8.10) gives the wanted result, since $\varepsilon > 0$. Making use of the other term in the expression (8.7) one gets the other estimate. \square

COROLLARY 8.7. *Let w_m and y_m be as above. Then, for fixed T , the sequences $F(w_m, y_m)$ and $G(w_m, y_m)$ are bounded in the Hilbert space $L^2(0, T; L^2(0, 1)) = L^2(Q)$.*

PROOF. From the Cauchy-Schwarz inequality it follows that

$$v^2(x, t) = 2 \int_0^x \frac{\partial v}{\partial \rho}(\rho, t) v(\rho, t) d\rho \leq 2 \|v[t]\|_1^2.$$

for all $v[t] \in H^1(0, 1)$.

Applying Corollary 8.6, and using the above inequality, we find

$$\|w_m^2[t]\|_0^2 = \int_0^x w_m^4(\rho, t) d\rho \leq \text{const}(T).$$

Repetition of the argument yields the boundedness of any product of any nonnegative integral power of w_m and y_m . \square

REMARK 8.8. The a priori estimates we have proved in Theorem 8.4 are slightly different from those derived by AUCHMUTY & NICOLIS in [4]. To say it in an unprecise, but suggestive manner, our estimates are the same as theirs, but are valid in Sobolev spaces one order higher. That is because we made more use of the infinite differentiability of the initial data and of the functions A and B . The reason why we did this is to simplify the argument in the next section. Especially, proceeding in the fashion we have done has the great advantage that we do not have to introduce Sobolev spaces of negative order.

9. THE EXISTENCE OF A (WEAK) SOLUTION OF THE EVOLUTION EQUATIONS FOR ALL TIME

In this section we wish to show that the sequences w_m and y_m have convergent subsequences with limit - in a sense that has to be specified - \tilde{w} and \tilde{y} , that are solutions of the weak problem (7.2)-(7.6) for $0 < t < T$, where T is arbitrary. The first step consists of proving the following property of solutions of the approximate problem (7.11), (7.12).

THEOREM 9.1. *Let $T > 0$, arbitrarily chosen, and let w_m and y_m be the solutions of (7.11), (7.12), whose existence on an interval $(0, t_m)$ is proved in section 7. Then, assuming that $t_m < T$, for all m these solutions can be continued to the interval $(0, T)$, i.e., w_m and y_m can be defined on (t_m, T) in such a manner that they satisfy (7.11) on the whole interval.*

PROOF. Since

$$\alpha_m^j(t) = (w_m[t], \phi_j)_0,$$

one has by the Cauchy-Schwarz inequality and the a priori estimate (8.10)

$$|\alpha_m^j(t)| \leq \|w_m[t]\|_0 \|\phi_j\|_0 \leq \text{const}(T)$$

for all $t \in [0, T]$ and an analogous upperbound for $\beta_m^j(t)$. Substituting the expressions (7.10) for $w_m[t]$ and $y_m[t]$ into the equations (7.11), one gets a system of $2m$ differential equations of the form

$$\dot{u} = f(u(t))$$

where $u(t) = (\alpha_m^1(t), \dots, \alpha_m^m(t), \beta_m^1(t), \dots, \beta_m^m(t))$. Of this equation the following three facts are known:

- (i) any solution v on the interval $[0, T]$ must always satisfy $|v(t)| \leq M$ for some constant $M > 0$;
- (ii) the right hand side is continuous and bounded on the tube $\{(t, v) \in \mathbb{R} \times \mathbb{R}^{2m} \mid 0 \leq t \leq T, |v(t)| \leq M\}$ and
- (iii) $u(t)$ is a solution on the subinterval $(0, t_m)$.

From these three facts the continuability of the solution $u(t)$ follows.

Hence the theorem is proved. \square

Above we have seen that the possibility of continuation of the solutions $w_m[t]$ and $y_m[t]$ to the interval $(0, T)$, where T is arbitrary positive, essentially is based on the first pair of a priori estimates for weak solutions of the reaction-diffusion problem.

The crucial role of the second pair of a priori estimates will be understood in the proof of our final existence theorem, in favour of which all the work above is done.

THEOREM 9.2. (*Existence of a weak solution for all time*). *The weak problem (7.2)-(7.6) has a solution $(\hat{w}[t], \hat{y}[t])$ for all time. For any $T > 0$, \hat{w} and \hat{y} belong to $L^2(0, T; H_0^1(0, 1))$.*

PROOF. Choose $T > 0$, arbitrarily. Let w_m and y_m be the approximate solutions on $(0, T)$, that is solutions of (7.9), (7.11) and (7.10), the existence of which is guaranteed by the foregoing theorem. From Corollary 8.5 we see that $\int_0^t \|w_m[t]\|_2^2 dt$ is bounded for all m (the upper bound of course is dependent on T), so $\{w_m\}$ is a bounded sequence in $L^2(0, T; H_0^1(0, 1) \cap H^2(0, 1))$. The same holds for $\{y_m\}$.

Since a bounded sequence in a Hilbert space is weakly compact, there exist a subsequences $\{w_k\}$ and $\{y_k\}$ of $\{w_m\}$ and $\{y_m\}$ respectively, such that as $k \rightarrow \infty$

$$(9.1) \quad \begin{cases} w_k \rightarrow \hat{w} \\ y_k \rightarrow \hat{y} \end{cases} \quad \text{weakly in } L^2(0, T; H_0^1(0, 1) \cap H^2(0, 1)).$$

Weak convergence here means that

$$\int_0^T (w_k[t], \psi[t])_1 dt \rightarrow \int_0^T (\hat{w}[t], \psi[t])_1 dt$$

for all $\psi \in L^2(0, T; H_0^1(0, 1))$ as $k \rightarrow \infty$.

However, we shall need more. We are now going to show - and this is the fundamental point - that the sequences $\{w'_m\}$ and $\{y'_m\}$ are bounded in $L^2(0, T; L^2(0, 1)) = L^2(Q)$.

Let P_m be the projection of the space $H_0^1(0, 1) \cap H^2(0, 1)$ into the linear span of the first m ϕ_j given by (7.7):

$$P_m : H_0^1(0,1) \cap H^2(0,1) \rightarrow [\phi_1, \dots, \phi_m].$$

It can be written as

$$P_m u = \sum_{i=1}^m (u, \phi_i)_0 \phi_i.$$

Of course, $P_m w_m' = w_m'$, $P_m y_m' = y_m'$, the primes denoting differentiation with respect to t . From (7.11) we deduce

$$(9.2) \quad \begin{cases} w_m' = D_1 P_m \Delta w_m + (D_2 - D_1) P_m \Delta y_m \\ \quad + P_m F(w_m, y_m) + P_m a, \\ y_m' = D_2 P_m \Delta y_m \\ \quad + P_m G(w_m, y_m) + P_m b. \end{cases}$$

Because of the special choice of the base $\{\phi_j\}$ the projection P_m has norm ≤ 1 . In Section 8 we have shown that $F(w_m, y_m)$ and $G(w_m, y_m)$ remain in a bounded set of $L^2(Q)$ for all m (Corollary 8.7) and that the operator $\Delta : H_0^1(0,1) \cap H^2(0,1) \rightarrow L^2(0,1)$ is bounded (Lemma 8.3). Hence the right hand sides of (9.2) remain in a bounded set of $L^2(Q)$ for all m , so indeed, we have proved that w_m' and y_m' are bounded sequences in $L^2(Q)$. So the subsequences $\{w_k\}$ and $\{y_k\}$ may be considered to be chosen in such a manner that

$$(9.3) \quad \begin{cases} w_k' \rightarrow \hat{w}' \\ y_k' \rightarrow \hat{y}' \end{cases} \quad \text{weakly in } L^2(Q).$$

That the limits of w_k' and y_k' are indeed \hat{w}' and \hat{y}' is seen as follows. Suppose that w_k' converges to a function $w^{(1)}$ in $L^2(Q)$ weakly, then

$$\begin{aligned} \int_0^T (w^{(1)}[t], \psi[t])_0 dt &= \lim_{k \rightarrow \infty} \int_0^T (w_k'[t], \psi[t])_0 dt \\ &= -\lim_{k \rightarrow \infty} \int_0^T (w_k[t], \psi'[t])_0 dt = - \int_0^T (\hat{w}[t], \psi'[t])_0 dt \\ &= \int_0^T (\hat{w}'[t], \psi[t])_0 dt \quad \text{for all } \psi \in L^2(0, T; H_0^1(0,1)), \end{aligned}$$

hence $w^{(1)} = \hat{w}$. Combining this result with the fact we already know that w_m and y_m are bounded sequences in $L^2(0, T; H_0^1(0, 1) \cap H^2(0, 1))$ we may conclude that w_m and y_m are bounded sequences in $H^1(Q)$. Since by Theorem 6.2 the injection $H^1(Q) \rightarrow L^2(Q)$ is compact, $\{w_k\}$ and $\{y_k\}$ have subsequences, which we again call $\{w_k\}$ and $\{y_k\}$, that converge in the L^2 -norm:

$$(9.4) \quad \begin{cases} w_k \rightarrow \hat{w} & \text{in } L^2(Q), \\ y_k \rightarrow \hat{y} & \text{in } L^2(Q). \end{cases}$$

Since convergence in L^2 implies convergence almost everywhere, we also have

$$(9.5) \quad \begin{cases} w_k(r, t) \rightarrow \hat{w}(r, t), & \text{almost everywhere} \\ y_k(r, t) \rightarrow \hat{y}(r, t), & \text{in } (0, 1) \times (0, T). \end{cases}$$

It remains to study the behaviour of the terms F and G in (7.11) as $k \rightarrow \infty$. As F is a linear combination of w_k and y_k , it is clear that

$$(9.6) \quad F(w_k, y_k) \rightarrow F(\hat{w}, \hat{y}) \text{ in } L^2(Q).$$

The nonlinear term, of course, causes more trouble. We know that the sequence $\chi_k = G(w_k, y_k)$ is bounded in $L_2(Q)$, so the subsequences $\{w_k\}$ and $\{y_k\}$ may be considered to be chosen such that

$$(9.7) \quad G(w_k, y_k) \rightarrow \chi \quad \text{weakly in } L^2(Q).$$

The point now is to prove that in (9.7) one may replace χ by $G(\hat{w}, \hat{y})$. To this end we need the following lemma.

LEMMA 9.3. *Let $\{g_k\}$ be a sequence of functions belonging to $L_2(Q)$, such that*

$$\|g_k\|_{L^2(Q)} \leq C$$

and

$$g_k \rightarrow g \quad \text{almost everywhere in } Q.$$

Then

$$g_k \rightarrow g \quad \text{weakly in } L^2(Q).$$

PROOF. Let N be an arbitrary positive integer. Introduce the subset E_N of Q

$$E_N = \{(x, t) \in Q \mid |g_k(x, t) - g(x, t)| \leq 1 \quad \text{for } k \geq N\}.$$

This sequence of sets increases as $N \rightarrow \infty$, and the measure of E_N increases to the measure of Q . Define S_N to be the set of functions in $L^2(Q)$ with support in E_N , and let $S = \bigcup_{N=1}^{\infty} S_N$. Then S is dense in $L^2(Q)$. Take $s \in S$, then

$$\int_Q s(g_k - g) \, dxdt \rightarrow 0 \quad \text{as } k \rightarrow \infty,$$

by virtue of the Lebesgue theorem on dominated convergence. This is seen as follows: s belongs to S_M for some M . Take $k \geq M$, then $|s(g_k - g)| \leq |s|$ and $g_k \rightarrow g$ almost everywhere. \square

CONTINUATION OF THE PROOF OF THEOREM 9.2. Application of Lemma 9.3 to

$g_k = G(w_k, y_k)$ gives

$$(9.8) \quad G(w_k, y_k) \rightarrow G(\hat{w}, \hat{y})$$

weakly in $L^2(Q)$, because $G(w_k, y_k)$ forms a bounded sequence in $L^2(Q)$, and because by (9.5) $G(w_k, y_k) \rightarrow G(\hat{w}, \hat{y})$ almost everywhere.

Now return to the system of equations (7.11). Fix j and choose $k > j$. Then, according to (7.11) one has

$$(9.9) \quad \begin{cases} (w_k, \phi_j)_0 = D_1(\Delta w_k, \phi_j)_0 + (D_2 - D_1)(\Delta y_k, \phi_j)_0 \\ \quad + (F(w_k, y_k), \phi_j)_0 + (a, \phi_j)_0 \\ (y_k, \phi_j)_0 = D_2(\Delta y_k, \phi_j)_0 \\ \quad + (G(w_k, y_k), \phi_j)_0 + (b, \phi_j)_0 \end{cases}$$

But, according to (9.1) it is true that

$$(\Delta w_k, \phi_j)_0 \rightarrow (\Delta \hat{w}, \phi_j)_0 \quad \text{weakly in } L^2(0, T).$$

From (9.6) and (9.8) it follows that

$$(F(w_k, y_k), \phi_j)_0 \rightarrow (F(\hat{w}, \hat{y}), \phi_j)_0 \quad \text{weakly in } L^2(0, T)$$

and

$$(G(w_k, y_k), \phi_j)_0 \rightarrow (G(\hat{w}, \hat{y}), \phi_j)_0 \quad \text{weakly in } L^2(0, T).$$

Finally, (9.3) implies

$$\begin{cases} (w_k', \phi_j)_0 \rightarrow (\hat{w}', \phi_j)_0, \\ (y_k', \phi_j)_0 \rightarrow (\hat{y}', \phi_j)_0, \end{cases} \quad \text{weakly in } L^2(0, T).$$

So it is allowed to take the limit $k \rightarrow \infty$ in (9.9), and we find

$$(9.10) \quad \begin{cases} (\hat{w}', \phi_j)_0 = D_1(\Delta \hat{w}, \phi_j)_0 + (D_2 - D_1)(\Delta \hat{y}, \phi_j)_0 \\ \quad + (F(\hat{w}, \hat{y}), \phi_j)_0 + (a, \phi_j)_0 \\ (\hat{y}', \phi_j)_0 = D_2(\Delta \hat{y}, \phi_j)_0 \\ \quad + (G(\hat{w}, \hat{y}), \phi_j)_0 + (b, \phi_j)_0 \end{cases}$$

for any fixed j . Since the functions ϕ_j are dense in $H_0^1(0, 1) \cap H^2(0, 1)$, it is proved that \hat{w} and \hat{y} satisfy equations (7.4).

All there remains to show is that \hat{w} and \hat{y} satisfy the initial conditions (7.5). We have found (see (9.1) and (9.3)) that

$$(9.11) \quad \begin{cases} w_k \rightarrow \hat{w} \\ y_k \rightarrow \hat{y} \end{cases} \quad \text{weakly in } H^1(0, T; H_0^1(0, 1)).$$

Theorem 6.11 implies that the limit also holds pointwise in t , especially for $t = 0$, so $w_k[0] \rightarrow \hat{w}[0]$ and $y_k[0] \rightarrow \hat{y}[0]$ weakly in $H_0^1(0, 1)$. But since e.g. $w_k[0] = w_{0k} \rightarrow w_0$ in $H_0^1(0, 1)$, one has the wished result. \square

REMARK 9.4. From the Sobolev imbedding theorem (see Theorem 6.2) and from the regularity theory for parabolic equation given in Chapter II it follows that the weak solution is a classical solution.

REMARK 9.5. (Continuation of Remark 8.8). As we noted before, using more of the smoothness of the data, we derived a priori estimates in Sobolev spaces one order higher than was done in AUCHMUTY & NICOLIS [4]. If we would not have done so, then from (9.2) one can see that one may not conclude that w'_m and y'_m remain bounded in $L^2(Q)$, but only in $L^2(0,T;H^{-1}(0,1))$. A more complex compactness result, which can be found in LIONS [5; p.57 ff.], is then needed.

10. STEADY STATE SOLUTIONS

Amongst all solutions of our system the steady state solutions are of particular importance. Such solutions play in the theory of nonlinear parabolic partial differential equations a role analogous to that of the critical points in the theory of ordinary differential equations. They are time invariant, and similar to the situation for ordinary differential equations, one often finds that the system evolves to steady state solutions as t increases to infinity.

Since steady state solutions do not depend on t , we write $X(r)$ and $Y(r)$ instead of $X(r,t)$ and $Y(r,t)$. These solutions obey equations (1.4) in which is set $\partial X/\partial t = \partial Y/\partial t = 0$, that is

$$(10.1) \quad \begin{cases} D_1 \frac{d^2 X}{dr^2} - (B+1)X + X^2 Y + A = 0, \\ D_2 \frac{d^2 Y}{dr^2} + BX - X^2 Y = 0, \quad 0 < r < 1. \end{cases}$$

They also fulfil the boundary conditions

$$(10.2) \quad \begin{cases} X(0) = X(1) = A_0, \\ Y(0) = Y(1) = B_0/A_0. \end{cases}$$

In this section and in section 14 we shall study the steady state solutions in the case that a rather specific choice for the data $A(r)$ and $B(r)$ is made. We make the following assumptions.

HYPOTHESES 10.1. The functions $A(r)$ and $B(r)$ will be chosen as

$$(10.3) \quad A(r) = A_0 \cosh(2\alpha(r-\frac{1}{2}))/\cosh \alpha, \quad 0 \leq r \leq 1,$$

where $\alpha \geq 0$, and

$$(10.4) \quad B(r) = B_0, \quad 0 \leq r \leq 1.$$

In view of (10.4) we shall drop the subscript 0 and write B instead of B_0 . Notice that these hypotheses are stricter than those made in section 1. We mention a number of immediate consequences of these hypotheses. First, there holds

$$(10.5) \quad 0 < A_0/\cosh \alpha \leq A(r) \leq A_0, \quad 0 \leq r \leq 1.$$

Further, $A(r)$ is a convex function of r . When $\alpha > 0$, then $A(r)$ is a solution of the boundary value problem

$$(10.6) \quad \begin{cases} D_A \frac{d^2 A}{dr^2} - A = 0, & 0 < r < 1, \\ A(0) = A(1) = A_0, \end{cases}$$

where $\alpha = \frac{1}{2} D_A^{-\frac{1}{2}}$. Finally, note that $A(r) \equiv A_0$ on $[0,1]$ if $\alpha = 0$.

In bifurcation theory one studies the possible steady state solutions of the dynamical system, for different values of a certain parameter. Moreover, one tries to acquire some qualitative knowledge about their nature. In our case the concentration of the reactant B will play the role of bifurcation parameter.

Let us first introduce some notations.

NOTATION 10.2. A solution $(X(r), Y(r))$ of (10.1)-(10.4) depends on the value of B . To stress this fact we write (X_B, Y_B, B) or (X, Y, B) to denote the solution corresponding to B . Let S be the family of all classical solutions (X, Y, B) of (10.1)-(10.4) for all $B \geq 0$. Clearly

$$S \subset C^2(0,1) \times C^2(0,1) \times [0, \infty).$$

Let T be a closed, connected subset of S . We call T a *tree* of solutions, as it consists of many *branches*. By T_0 we denote the tree starting from $(X, Y, 0)$. We are especially interested in the solutions belonging to this tree of solutions, which consists of all solutions that are connected to the solution $(X, Y, 0)$, the existence and uniqueness of which is demonstrated later on in this section.

In Section 4 maximum principles played an important role in our investigation. Here too, it will be seen that maximum principles, now for elliptic instead of parabolic equations, may be applied successfully.

First, we give a rather general result for nonnegative solutions.

THEOREM 10.3. Let (X, Y, B) be a nonnegative solution of (10.1)-(10.4) with $B \geq 0$ and $\alpha > 0$ (i.e., $A(r) \neq A_0$). Then

$$(10.7) \quad \begin{cases} X(r) \leq A_0 + \frac{D_2 B}{D_1 A_0} + \frac{D_A}{D_1} (A_0 - A(r)), \\ Y(r) \leq \frac{B}{A_0} + \frac{D_1 A_0}{D_2} + \frac{D_A}{D_2} (A_0 - A(r)), \end{cases} \quad 0 \leq r \leq 1.$$

PROOF. Define $Z(r) = D_1 X(r) + D_2 Y(r) + D_A A(r)$. Then from (10.1)-(10.4) and the assumed nonnegativity it follows that

$$Z''(r) = X(r) \geq 0$$

and

$$Z(0) = Z(1) = (D_1 + D_A) A_0 + D_2 B / A_0.$$

Here, and henceforth, in contrast to the preceding sections, the prime denotes differentiation with respect to r . The simplest form of the maximum principle, based on convexity of the function $Z(r)$, implies

$$Z(r) \leq (D_1 + D_A)A_0 + D_2 B/A_0,$$

or

$$0 \leq D_1 X(r) + D_2 Y(r) \leq D_1 A_0 + D_2 B/A_0 + D_A (A_0 - A(r)).$$

The inequalities (10.7) are contained in the last inequalities. \square

COROLLARY 10.4. *Let in Theorem 10.3 $\alpha = 0$ (i.e., $A(r) \equiv A_0$). Then instead of (10.7) one has*

$$(10.8) \quad \begin{cases} X(r) \leq A_0 + \frac{D_2 B}{D_1 A_0} + \frac{A_0}{2D_1} r(1-r), \\ Y(r) \leq \frac{B}{A_0} + \frac{D_1 A_0}{D_2} + \frac{A_0}{2D_2} r(1-r), \end{cases} \quad 0 \leq r \leq 1.$$

PROOF. Replace $Z(r)$ in the previous proof by

$$Z(r) = D_1 X(r) + D_2 Y(r) - \frac{A_0}{2} r(1-r).$$

Proceeding in the same fashion as above, one gets the result. \square

Now we wish to show that the tree T_0 is not empty. To this end we need the following version of the maximum principle, which is closely related to Theorem II.1.1.

THEOREM 10.5. *Suppose $u \in C^0[0,1] \cap C^2(0,1)$, $g, h \in C^0[0,1]$, and $h(r) \leq 0$ on $[0,1]$. If u satisfies the differential inequality*

$$u''(r) + g(r)u'(r) + h(r)u(r) \geq 0, \quad 0 < r < 1,$$

then

$$u(r) \leq \max\{0, u(0), u(1)\}.$$

PROOF. This theorem is an immediate consequence of Theorem 3 in Chapter 1 of PROTTER & WEINBERGER [8]. \square

The next step is to prove the existence of a steady state solution for $B = 0$.

LEMMA 10.6. *When $B = 0$, there is a unique solution $(X(r), Y(r), 0) = (X(r), 0, 0)$ of (10.1)-(10.4), with $0 < X(r) \leq A_0$ for $0 \leq r \leq 1$.*

PROOF. When $B = 0$, $Y(r)$ satisfies

$$D_2 Y'' - X^2 Y = 0$$

subject to

$$Y(0) = Y(1) = 0.$$

From the maximum principle in the form given above, the only possible solution is $Y(r) \equiv 0$, $0 \leq r \leq 1$. The first equation (10.1) becomes linear:

$$(10.9) \quad D_1 X'' - X = -A(r), \quad X(0) = X(1) = A_0$$

Of this equation the solution is easily found. Applying Theorem 10.5 to equation (10.9) with X replaced by $-X$, one sees that $X(r) \geq \min(0, A_0) = 0$. The strict inequality is found by a more delicate argument. If $X(s) = 0$ for some $0 < s < 1$, then it must have a local minimum in s , so $X''(s) \geq 0$. This contradicts (10.9), as $-A(r) < 0$ for all $0 < r < 1$.

To get the upper bound, let $u(r) = X(r) - A_0$. Then

$$\begin{aligned} D_1 u'' - u &= A_0 - A(r) \geq 0, \\ u(0) &= u(1) = 0. \end{aligned}$$

Again by the maximum principle just given, one obtains $u(r) \leq 0$, or $X(r) \leq A_0$. \square

After having constructed a solution for $B = 0$, we must look at what happens if B becomes (slightly) greater than 0.

THEOREM 10.7. *There exists a $\delta > 0$ such that for $0 \leq B < \delta$, there exists a nonnegative solution (X_B, Y_B, B) of (10.1)-(10.4).*

PROOF. Making the boundary conditions (10.2) homogeneous, that is taking

$$x(r) = X(r) - A_0, \quad y(r) = Y(r) - B/A_0$$

one obtains

$$(10.10) \quad \begin{cases} D_1 x'' + (B-1)x + A_0^2 y + A(r) - A_0 + h(x, y) = 0 \\ D_2 y'' - B_x - A_0^2 y - h(x, y) = 0 \end{cases}$$

which is (3.2) for time independent x and y and constant B . Let $G(r, \rho)$ be the Green's function for the operator $-d^2/dr^2$ (see e.g. TEMME [11, section V.6] or STAKGOLD [17]), then the system of differential equations (10.10) can be written in the integral equation form

$$\begin{pmatrix} x(r) \\ y(r) \end{pmatrix} = \int_0^1 \begin{pmatrix} D_1 G(r, \rho) & 0 \\ 0 & D_2 G(r, \rho) \end{pmatrix} \begin{pmatrix} f_1(\rho, x(\rho), y(\rho)) \\ f_2(\rho, x(\rho), y(\rho)) \end{pmatrix} d\rho,$$

where f_1 and f_2 are defined as in (3.8). This equation in its turn may be considered as an equation in the space $C_0^0[0,1] \times C_0^0[0,1]$

$$(10.11) \quad \begin{pmatrix} x \\ y \end{pmatrix} - T \begin{pmatrix} f_1(x, y) \\ f_2(x, y) \end{pmatrix} = 0.$$

The left hand side of (10.11), of course, depends on B , and so it may be considered as a function $f(B; x_B, y_B)$, of which we know by the preceding theorem that there are a x_0 and $y_0 (=0)$ such that $f(0; x_0, 0) = 0$. By the implicit function theorem (see e.g. TEMME [11, p.78] or BROWN & PAGE [16, p.290]) it then follows that there exists a $\delta > 0$ such that (10.11) has a unique solution $(x_B(r), y_B(r), B)$ for $0 \leq B < \delta$, satisfying $(X_B(r), Y_B(r)) \rightarrow (X_0(r), 0)$ in $C_0^0[0,1] \times C_0^0[0,1]$ as $B \rightarrow 0$.

The proof of the nonnegativity of the solutions is postponed; until the Theorem 10.9. \square

For small B one also has uniqueness.

THEOREM 10.8. *There exists a $\eta > 0$ such that for $0 < B < \eta$, there is at most one non-negative solution of (10.1)-(10.4).*

PROOF. Suppose that the theorem is false, then there is a sequence $\{B_k\}$ converging to 0, and for each k there exist at least two solutions, say (X_k, Y_k) and $(\tilde{X}_k, \tilde{Y}_k)$. Since both solutions must obey the bounds given by Theorem 10.3, they must have limit points (X_0, Y_0) and $(\tilde{X}_0, \tilde{Y}_0)$ in $(C^0[0,1])^2$.

Both must be solutions of (10.1)-(10.4) with $B = 0$. If $X_0 \neq \tilde{X}_0$ and $Y_0 = \tilde{Y}_0$ on $0 \leq r \leq 1$, there would be a contradiction with Lemma 10.6. If $X_0 = \tilde{X}_0$ and $Y_0 = \tilde{Y}_0$, then one would have that $B = 0$ is a bifurcation point for (10.1)-(10.4), as in any neighbourhood of $(X_0, Y_0, 0)$ in $C^2[0,1] \times C^2[0,1] \times [0, \infty)$ there would be more than one solution. Later on, in Section 12, it will be shown that this is impossible. Thus the theorem is true by contradiction. \square

We conclude this section by proving that any solution (X, Y, B) that may be connected with $(X, Y, 0) = (X, 0, 0)$ is non-negative.

THEOREM 10.9. *If (X_B, Y_B, B) belongs to T_0 then $X_B(r) \geq 0$ and $Y_B(r) \geq 0$, $0 \leq r \leq 1$.*

PROOF. First note that if $X_B(r) \geq 0$ for $0 \leq r \leq 1$, then from Theorem 10.5, a maximum principle for ordinary differential equations, from the equation

$$D_2 Y'' - X^2 Y = -BX$$

and the boundary conditions (10.2) for Y , one gets $Y_B(r) \geq 0$.

So for this theorem to hold it is sufficient to prove the following statement: if (X, Y, B) is in T_0 , then $X(r) \geq 0$ for $0 \leq r \leq 1$. This is proved using a homotopy argument. If (X, Y, B) is in T_0 , then there is a continuous mapping $X: [0, B] \rightarrow C^2(0, 1)$ such that for each $b \in [0, B]$, $X(b)$ is the X -component of the solution of (10.1)-(10.4), and that $X(0) = X_0$, $X(B) = X$. Define:

$$m(b) = \inf_{0 \leq r \leq 1} \{A_0 - X_b(r)\}.$$

From Lemma 10.6, $m(0) > 0$, and since X depends continuously on b , $m(b)$ is a continuous function of b .

Now suppose there is a b where $m(b) = 0$ and let b_0 be the smallest b_0 for which this is true. Then there is a solution $X(b_0; r)$ of (10.1)-(10.4) and a point r_0 in $(0, 1)$ such that

$$X(b_0; r_0) = 0 \text{ and } X''(b_0; r_0) \geq 0$$

as $X(b_0, r_0)$ attains its minimum at r_0 . But from (10.1)

$$D_1 X''(b_0, r_0) = -A(r_0).$$

Since $A(r) > 0$ for all $0 \leq r \leq 1$, this is impossible, so there is no such b_0 . Thus the theorem is proved. \square

11. LINEAR STABILITY ANALYSIS

In this section and in the Sections 12 and 13 it is assumed that $A(r) = A_0$ for $0 \leq r \leq 1$. In the following we drop the subscript and write A instead of A_0 . In this section the stability of the steady state solution

$$(11.1) \quad X(r) = A, \quad Y(r) = B/A$$

of (1.4) with boundary values (1.11) is investigated. We are particularly interested in the dependence upon the parameter B . Let again, as in (3.1),

$$(11.2) \quad \begin{aligned} X(r, t) &= A + x(r, t) \\ Y(r, t) &= B/A + y(r, t). \end{aligned}$$

Substitution in (1.4) gives the system

$$(11.3) \quad \begin{cases} \frac{\partial x}{\partial t} = D_1 \frac{\partial^2 x}{\partial r^2} + (B-1)x + A^2 y + h(x, y) \\ \frac{\partial y}{\partial t} = D_2 \frac{\partial^2 y}{\partial r^2} - Bx + A^2 y - h(x, y) \end{cases}$$

with

$$h(x, y) = (B/A^2)x^2 + (2A+x)xy,$$

and with boundary conditions

$$(11.4) \quad x(0,t) = y(0,t) = x(1,t) = y(1,t) = 0.$$

By the transformation (11.2) the steady state solution (11.1) becomes

$$(11.5) \quad x(r,t) = 0, \quad y(r,t) = 0.$$

We will use the principle of linearized stability. Let

$$(11.6) \quad \begin{cases} \frac{\partial x}{\partial t} = D_1 \frac{\partial^2 x}{\partial r^2} + (B-1)x + A^2 y, \\ \frac{\partial y}{\partial t} = D_2 \frac{\partial^2 y}{\partial r^2} + Bx - A^2 y, \end{cases}$$

be the linearization of (11.3) at $(x,y) = (0,0)$.

Applying separation of variables we obtain

$$(11.7) \quad \begin{pmatrix} x(r,t) \\ y(r,t) \end{pmatrix} = \begin{pmatrix} u(r) \\ v(r) \end{pmatrix} e^{\lambda t},$$

with $u(r)$ and $v(r)$ satisfying

$$(11.8) \quad \begin{cases} D_1 \frac{d^2 u}{dr^2} + (B-1)u + A^2 v = \lambda u \\ D_2 \frac{d^2 v}{dr^2} - Bu - A^2 v = \lambda v, \end{cases}$$

or

$$(11.9) \quad L_B \begin{pmatrix} u \\ v \end{pmatrix} = \lambda \begin{pmatrix} u \\ v \end{pmatrix},$$

where L_B is a linear differential operator. Its adjoint L_B^* is given by

$$(11.10) \quad L_B^* \begin{pmatrix} u \\ v \end{pmatrix} = \begin{pmatrix} D_1 \frac{d^2 u}{dr^2} + (B-1)u - Bv \\ D_2 \frac{d^2 v}{dr^2} + A^2 u - A^2 v \end{pmatrix}.$$

For (11.8) we try a solution of the type

$$\begin{pmatrix} u \\ v \end{pmatrix} = \begin{pmatrix} \alpha \\ \beta \end{pmatrix} e^{\mu r},$$

and obtain the equations

$$(11.11) \quad \begin{cases} (D_1 \mu^2 + B - 1 - \lambda) \alpha + A^2 \beta = 0, \\ -B \alpha + (D_2 \mu^2 - A^2 - \lambda) \beta = 0. \end{cases}$$

Thus, such a nontrivial solution only exists if

$$(11.12) \quad (D_1 \mu^2 + B - 1 - \lambda) (D_2 \mu^2 - A^2 - \lambda) + A^2 B = 0$$

and then we have a general solution of the form

$$\begin{pmatrix} u \\ v \end{pmatrix} = C_1 \begin{pmatrix} \alpha_1 \\ \beta_1 \end{pmatrix} e^{\mu_1 r} + C_2 \begin{pmatrix} \alpha_1 \\ \beta_1 \end{pmatrix} e^{-\mu_1 r} + C_3 \begin{pmatrix} \alpha_2 \\ \beta_2 \end{pmatrix} e^{\mu_2 r} + C_4 \begin{pmatrix} \alpha_2 \\ \beta_2 \end{pmatrix} e^{-\mu_2 r},$$

where $\pm \mu_1$ and $\pm \mu_2$ are solutions of (11.12). The vectors (α_1, β_1) and (α_2, β_2) satisfy (11.11) for $\mu = \pm \mu_1$ and $\mu = \pm \mu_2$, respectively.

Substituting the boundary conditions $u(0) = v(0) = u(1) = v(1) = 0$ into the general solution, we find that $C_1 = -C_2$, $C_3 = -C_4$ and $\mu_{1,2} = i\pi m_{1,2}$ and that for $\mu_1 \neq i\pi m$, necessarily $C_1 = C_2 = 0$. A same argument applies to μ_2 , C_3 and C_4 . Consequently, the eigenfunctions have the form

$$(11.13) \quad \begin{pmatrix} u_m \\ v_m \end{pmatrix} = \begin{pmatrix} \alpha \\ \beta \end{pmatrix} \sin m\pi r$$

with $m = 1, 2, \dots$. According to (11.12) the corresponding eigenvalues are

$$(11.14) \quad \lambda_m^\pm(B) = \frac{1}{2} p_m(B) \pm \frac{1}{2} \sqrt{g_m(B)}$$

where

$$p_m(B) = B - 1 - A^2 - m^2 \pi (D_1 + D_2),$$

$$g_m(B) = \{B - 1 + A^2 + m^2 \pi^2 (D_1 - D_2)\}^2 - 4A^2 B.$$

DEFINITION 11.1. The solution (11.5) of the system (11.3) is said to be linearly stable if for all $m \operatorname{Re} \lambda_m^\pm(B) < 0$.

DEFINITION 11.2. The solution (11.5) of the system (11.3) is said to be linearly unstable if for some $m \operatorname{Re} \lambda_m^\pm(B) > 0$.

The principle of linearized stability is expressed by the conjecture that linear stability of the solution (11.5) of (11.3) implies the stability of this solution and that linear instability implies the instability. For systems with one component the principle has proved to be correct, see Theorem 8.3 of Chapter I, Theorem 5.4 of Chapter III and also Theorem 7.1 of Chapter V. For the proof that the principle holds for the above system with two components no reference is available in literature, as far as we know.

From point of view of bifurcation theory (see TEMME [11, Ch. IV and VII]) one is interested in the values of B for which $\operatorname{Re} \lambda_m^\pm(B)$ vanishes for some m . At such point a bifurcating solution of the steady state equations may arise. We consider the set of points R for which a real eigenvalue (11.14) changes sign. Let

$$(11.15) \quad B_m^{(r)} = 1 + \frac{D_1}{D_2} A^2 + m^2 D_1 \pi^2 + \frac{A^2}{D_2 m^2 \pi^2}$$

then

$$(11.16) \quad R = \{B_m^{(r)} \mid m \in \mathbf{N}, g_m(B_m^{(r)}) \geq 0\}.$$

Similarly we introduce the set of points C for which the real parts of two complete conjugated eigenvalues change sign. Let

$$(11.17) \quad B_m^{(c)} = 1 + A^2 + m^2 \pi^2 (D_1 + D_2),$$

then the set C is defined by

$$(11.18) \quad C = \{B_m^{(c)} \mid m \in \mathbf{N}, g_m(B_m^{(c)}) < 0\}.$$

In the sequel, it is assumed that A , D_1 and D_2 satisfy additional conditions such that eigenvalues with vanishing real parts are simple for these values of B . These conditions and further properties of the eigenvalues (11.14) are worked out in AUCHMUTY & NICOLIS [4]. It is remarked that

Re $\lambda_m^\pm(0) < 0$ for all $m \geq 1$ and that also $B_m^{(r)}, B_m^{(c)} > 0$ for all m , which means that the steady state solution (11.1) is linearly stable for $B = 0$ and that, because of the continuity of $\lambda_m^\pm(B)$ the stability is also ensured for $0 < B < B_c$, where

$$(11.19) \quad B_c = \min[R, C].$$

This minimum value is attained for $m = m_c$, the so-called *critical wave number*. If $B_c = B_{m_c}^{(r)}$, the eigenvector corresponding with the eigenvalue 0 is given by

$$(11.20) \quad \begin{pmatrix} u_{m_c} \\ v_{m_c} \end{pmatrix} = \begin{pmatrix} 1 \\ \delta \end{pmatrix} \sin m_c \pi r, \quad \delta = (D_1 m_c^2 \pi^2 + 1 - B_c) / A^2.$$

The minimum value of the set C is attained for $m = 1$.

12. BIFURCATION OF DISSIPATIVE STRUCTURES

In Section 11 we have shown that a critical value B_c exists; below this value the steady state solution (11.1) is asymptotically stable, while for $B > B_c$ it becomes unstable. We will see that near B_c (and other points) steady state solutions different from (11.1) may exist. These solutions arise as new branches of the steady state equations and may run far away from the thermodynamic branch. These nonuniform solutions are called *dissipative structures* and occur in open systems. The branching may take place for $B = B_m^{(r)}$. In this section we will analyse the possible bifurcation at these points. In particular we are concerned with the case $B_c = B_{m_c}^{(r)}$, see (11.19). Writing

$$(12.1) \quad \begin{aligned} X(r, t) &= A + x(r, t) \quad , \\ Y(r, t) &= B/A + y(r, t) \quad , \end{aligned}$$

we obtain the steady state equations in the form

$$(12.2) \quad \begin{aligned} D_1 \frac{d^2 x}{dr^2} + (E-1)x + A^2 y &= -h(x,y) \\ D_2 \frac{d^2 y}{dr^2} + Bx - A^2 y &= h(x,y), \end{aligned}$$

with

$$h(x,y) = (B/A^2)x^2 + (2A+x)xy.$$

Using (11.9) we also may write

$$(12.3) \quad L_B \begin{pmatrix} x \\ y \end{pmatrix} = \begin{pmatrix} -h(x,y) \\ h(x,y) \end{pmatrix}.$$

When the operator L_B has no zero eigenvalue, that is for $B \neq B_m^{(r)}$, L_B is invertible and equation (12.3) is equivalent to the integral equation

$$(12.4) \quad \begin{pmatrix} x(r) \\ y(r) \end{pmatrix} = \int_0^1 G(B,r,s) \begin{pmatrix} -h(x(s),y(s)) \\ h(x(s),y(s)) \end{pmatrix} ds,$$

where G is the matrix Green's function for L_B . The operator $G_B: C(0,1) \times C(0,1) \rightarrow C(0,1) \times C(0,1)$ defined by

$$(12.5) \quad G_B \begin{pmatrix} u(r) \\ v(r) \end{pmatrix} = \int_0^1 G(B,r,s) \begin{pmatrix} u(s) \\ v(s) \end{pmatrix} ds$$

is a compact linear operator, depending analytically on B for $B_m < B < B_{m+1}$, $m = 0, 1, 2, \dots$ with $B_0 = 0$ and $B_m = B_m^{(r)}$, $m = 1, 2, \dots$. The functions $x(r) \equiv 0$ and $y(r) \equiv 0$ are solutions of (12.3) for all values of B . For $B = B_m^{(r)}$, new branches of steady-state solutions can bifurcate from the trivial solution. By application of the implicit function theorem one is able to give a necessary condition for having a bifurcation point, see Corollary 3.4 of TEMME [11, Ch.IV]. In Theorem 3.6 of this reference a sufficient condition for bifurcation is formulated. The method we use to study this bifurcation is related to SATTINGER's approach [18] and uses as ansatz that both the bifurcating solution and the parameter B admit a power series expansion in a new parameter ϵ . Later on it will become clear why the introduction of a new parameter is needed. Let us consider the case $B_c = B_m^{(r)}$, see (11.19). Near B_c the expansion is formally

$$(12.6) \quad B = B_c + \epsilon \gamma_1 + \epsilon^2 \gamma_2 + \dots$$

For the solution $(x(r), y(r))$ of (12.3) we introduce the expansion

$$(12.7) \quad \begin{pmatrix} x(r) \\ y(r) \end{pmatrix} = \epsilon \begin{pmatrix} x_1(r) \\ y_1(r) \end{pmatrix} + \epsilon^2 \begin{pmatrix} x_2(r) \\ y_2(r) \end{pmatrix} + \dots$$

Substitution of (12.6) and (12.7) into (12.3) yields, after equating the coefficients of equal powers of ϵ a recurrent system

$$(12.8) \quad L_{B_c} \begin{pmatrix} x_k(r) \\ y_k(r) \end{pmatrix} = \begin{pmatrix} -a_k \\ a_k \end{pmatrix}, \quad k = 1, 2, 3, \dots$$

with

$$\begin{aligned} a_1 &= 0 \\ a_2(x_1, y_1; A, B_c) &= \gamma_1 x_1 + (B_c/A^2) x_1^2 + 2Ax_1 y_1, \\ a_3(x_1, y_1, x_2, y_2; A, B_c) &= \gamma_2 x_1 + \{\gamma_1 + 2(B_c/A^2) x_1 + 2Ay_1\} x_2 + \\ &\quad 2Ax_1 y_2 + \gamma_1 x_1^2/A + x_1^2 y_1, \dots \end{aligned}$$

Equation (12.8) with $k = 1$ is satisfied by the eigenvector (11.20) with an arbitrary multiplicative constant, which we set equal 1. According to Fredholm's alternative, see Theorem 4.28 of TEMME [11. Ch.VI], the non-homogeneous equations (12.8) with $k = 2, 3, \dots$ have a solution only if the right-hand side is orthogonal to the corresponding eigenvector of the adjoint homogeneous problem. This theorem applies to compact linear operators. It is seen that the corresponding integral equation contains the operator G_B meeting this requirement, so that indeed the Fredholm alternative can be used for this problem. The adjoint homogeneous problem has the form

$$(12.9) \quad L_{B_c}^* \begin{pmatrix} u \\ v \end{pmatrix} = 0,$$

with $u(0) = v(0) = u(1) = v(1) = 0$; the operator $L_{B_c}^*$ is given in (11.8). This eigenvector reads

$$\begin{pmatrix} u(r) \\ v(r) \end{pmatrix} = \begin{pmatrix} \eta \\ 1 \end{pmatrix} \sin m_c \pi r, \quad \eta = 1 + D_2 m_c^2 \pi^2 / A^2,$$

so that the orthogonality condition becomes

$$\int_0^1 \{-a_k u + a_k v\} dr = 0,$$

or

$$(12.11) \quad \int_0^1 a_k \sin m_c \pi r \, dr = 0.$$

For $k = 2$ this condition produces a value for γ_1 :

$$(12.12) \quad \gamma_1 = 0 \quad \text{for } m_c \text{ is even,}$$

and

$$(12.13) \quad \gamma_1 = - \frac{8(B_c + 2A^2\delta)}{3m_c\pi A} \quad \text{for } m_c \text{ is odd.}$$

It is remarked that by introduction of the expansion of B near B_c in the new parameter ϵ , sufficient degrees of freedom are created to satisfy the orthogonality conditions (22.11) with $k = 2, 3, 4, \dots$.

We first consider the case m_c is *even*. Substitution of $x_1(r)$, $y_1(r)$ and $\gamma_1 = 0$ into equation (12.8) with $k = 2$ gives a linear, nonhomogeneous system of equations for $x_2(r)$ and $y_2(r)$. Using Fourier series expansion we are able to write the solution in the form

$$(12.14) \quad \begin{pmatrix} x_2(r) \\ y_2(r) \end{pmatrix} = \sum_{\substack{n=1 \\ n \text{ odd}}}^{\infty} \begin{pmatrix} \alpha_n(A, D_1, D_2, m_c) \\ \beta_n(A, D_1, D_2, m_c) \end{pmatrix} \sin n\pi r.$$

Condition (12.11) with $k = 3$ yields an expression for γ_2 , which we write as

$$(12.15) \quad \gamma_2 = f(A, D_1/D_2).$$

Summarizing these results we have found expressions for the first two terms of the power series expansion (12.7) of the bifurcating solution near $B = B_c$, where $x_1(r)$ and $y_1(r)$ are given by (11.9) with $m = m_c$ and $x_2(r)$ and $y_2(r)$ have the form (12.14). For B we have

$$(12.16) \quad B = B_c + \epsilon^2 \gamma_2 + \dots,$$

where γ_2 may be either positive or negative depending on the values of A and D_1/D_2 . From (12.16) it follows that

$$(12.17) \quad \epsilon \approx \pm \sqrt{(B - B_c)/\gamma_2},$$

so a bifurcating solution is found for $B > B_c$ if $\gamma_2 > 0$ and for $B < B_c$ if $\gamma_2 < 0$. If $\gamma_2 = 0$ the next order term of (12.16) has to be computed in order to obtain an insight in the branching process for the steady state equations at $B = B_c$. In figure 1a we sketch the bifurcation at $B = B_c$ for $\gamma_2 > 0$ and in figure 1b the result for $\gamma_2 < 0$ is given. From the preceding theory (Theorem 10.8) we know that the branches are bounded away from the line $B = 0$; this explains the anticipated behaviour for ε large. We see that for $\gamma_2 < 0$ stable dissipative structures are possible in the subcritical case ($B < B_c$). Starting from the thermodynamic branch they only can be reached by a sudden jump, forced from the outside, which is needed to pass the unstable non-uniform steady states. For $\gamma_2 < 0$ as well as for $\gamma_2 > 0$ the uniform steady state (11.1) becomes unstable as B crosses B_c and two dissipative structures may arise, which turn out to be linearly stable. These two solutions of the form (12.7) have leading terms which differ only in sign. The passage of the critical value B_c is called a symmetry breaking transition, which refers to the occurrence of these two distinct, nonuniform steady states for which a local maximum of the one is attained at a local minimum of the other. It is also seen from (12.14) that because of the infinite series with $\sin n\pi r$ subharmonic terms may arise which only vanish under very specific conditions. These terms are due to the nonlinearity in the problem and they introduce *spatial asymmetry* in the solutions.

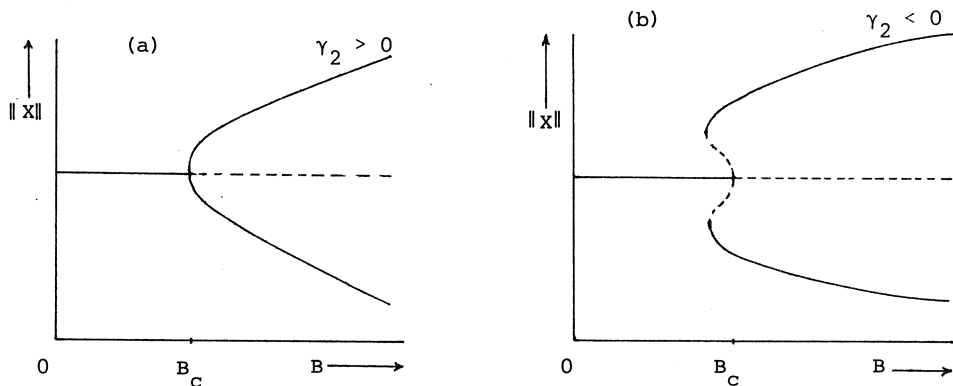

Figure 1. Bifurcation for m_c even.

Next we consider the case with m_c odd. We already derived an expression for γ_1 , see (12.13). Since a_2 is known at this stage, equation (12.8) with $k = 2$ can be solved, giving expressions for $x_2(r)$ and $y_2(r)$ similar to those for m_c even. For B we have the expansion

$$(12.18) \quad B = B_c + \varepsilon \gamma_1 + \varepsilon^2 \gamma_2 + \dots,$$

so that

$$(12.19) \quad \begin{pmatrix} x(r) \\ y(r) \end{pmatrix} \approx \begin{pmatrix} x_1(r) \\ y_1(r) \end{pmatrix} \frac{B - B_c}{\gamma_1}.$$

Consequently, a bifurcating solution exists for $B < B_c$ as well as for $B > B_c$, see Figure 2. Again the branches are bounded away from the line $B = 0$.

In Figure 2 it is observed that for an adiabatic variation of B near B_c a solution will remain on branches (a_1) or (b_2) . A sudden jump of B , however, could lead to solutions on either branches (b_2) or (c_2) . Let such change of B give a solution on (c_2) . Then a decreasing B will bring us on the part (c_1) and a further decrease would give again the thermodynamic branch (a_1) . This different behavior for increasing and decreasing B is called *hysteresis*.

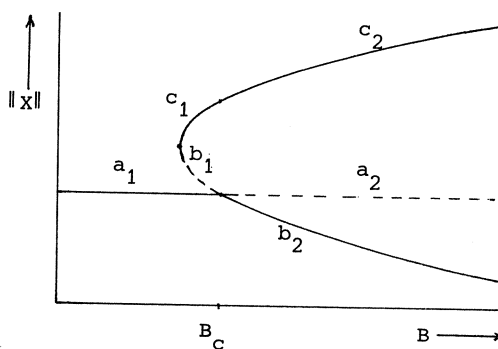

Figure 2. Bifurcation for m_c odd.

In Section 11 we defined the minimum B_c of the sets of points for which the real part of the eigenvalue $\lambda^\pm(B)$ vanishes. In this section we restricted ourselves to the point $B \in \mathbb{R}$ for which a real eigenvalue vanishes. In particular we were interested in the case $B = B_{m_c}^{(r)}$. For the other points we may

proceed in a similar way. The result is that for increasing B an increasing number of nonuniform steady states is possible, see figure 3a. With respect to the phenomenon of *repeated branching*, it is worth to mention also a recent paper of MAHAR & MATKOWSKY [19], who analyse the linear stability problem for the bifurcating steady state solutions we dealt with in this section. They consider the parameter ϵ as the eigenvalue parameter of this problem (so ϵ takes over the role of B). If for a critical value of ϵ the bifurcating solution becomes unstable a *secondary bifurcation* may arise. In this way the branching process forms a tree as depicted in Figure 3b. The method makes use of power series expansions with respect to the parameter

$$\kappa = m^2(m+1)^2 - A^2/\pi^4 D_1 D_2,$$

which is a measure for the distance between the two in absolute value smallest eigenvalues of (11.14).

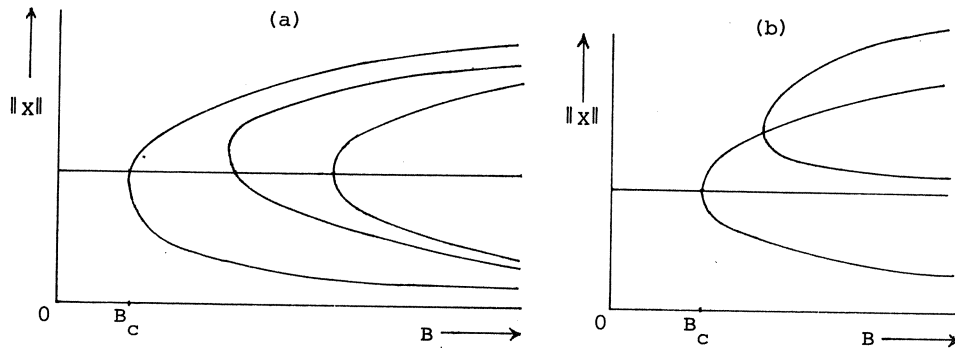

Figure 3. Repeated branching.

13. BIFURCATION OF TIME PERIODIC SOLUTIONS

In this section we consider the case where the real parts of two complex conjugated eigenvalues change sign; that is for $B = C$, see (11.18). Let us take

$$B_c = B_1^{(c)}.$$

We will see that the thermodynamic equilibrium becomes unstable as B crosses the critical value B_c and that a time periodic solution exists for $B > B_c$. For ordinary differential equations with a bifurcation parameter this phenomenon is known as Hopf bifurcation, see TEMME [11]. For partial differential equations this problem has been studied in relation with the Navier-Stokes equations for the Reynolds number R crossing a critical value R_c , see D.D. JOSEPH & D.H. SATTINGER [20] and G. IOOSS [21].

Let equation (11.3) have time periodic solutions with period $2\pi/\omega$. Introduction of the new dependent variables x and y given by (12.1) and a new time scale $\tau = \omega t$ transforms equation (11.3) into

$$(13.1) \quad \omega \frac{\partial}{\partial \tau} \begin{pmatrix} x \\ y \end{pmatrix} = L_B \begin{pmatrix} x \\ y \end{pmatrix} + \begin{pmatrix} h(x,y) \\ -h(x,y) \end{pmatrix}.$$

It is assumed that a 2π -periodic solution of (13.1) with B near B_c has an expansion in terms of powers of a parameter ϵ

$$(13.2) \quad \begin{pmatrix} x(r,\tau) \\ y(r,\tau) \end{pmatrix} = \epsilon \begin{pmatrix} x_1(r,\tau) \\ y_1(r,\tau) \end{pmatrix} + \epsilon^2 \begin{pmatrix} x_2(r,\tau) \\ y_2(r,\tau) \end{pmatrix} + \dots,$$

and that also

$$(13.3) \quad \omega = \mu + \epsilon \omega_1 + \epsilon^2 \omega_2 + \dots,$$

$$(13.4) \quad B = B_c + \epsilon \gamma_1 + \epsilon^2 \gamma_2 + \dots,$$

with

$$\mu = \text{Im } \lambda^+(B_c), \quad B_c = B_1^{(c)}.$$

Substituting (13.2), (13.3) and (13.4) into (13.1) and equating coefficients of equal powers of ϵ , we obtain

$$(13.5) \quad \mu \frac{\partial}{\partial \tau} \begin{pmatrix} x_n \\ y_n \end{pmatrix} - L_{B_c} \begin{pmatrix} x_n \\ y_n \end{pmatrix} = - \sum_{k=1}^{n-1} \omega_k \frac{\partial}{\partial \tau} \begin{pmatrix} x_{n-k} \\ y_{n-k} \end{pmatrix} + \begin{pmatrix} a_n \\ -a_n \end{pmatrix},$$

with $a_n(x_1, y_1, \dots, x_{n-1}, y_{n-1}; A, B_c)$ as given in section 12. For $n = 1$ the solution of (13.5) has the form

$$\begin{pmatrix} x_1(r,\tau) \\ y_1(r,\tau) \end{pmatrix} = k \begin{pmatrix} u(r) \\ v(r) \end{pmatrix} e^{i\tau},$$

where k is an arbitrary complex constant. The vector function $(u(r), v(r))$ is the complex eigenfunction of L_{B_c} with eigenvalue $i\mu$, see section 11. Similar to the operator G_B of (12.5) one may define a compact linear operator being the two-dimensional version of the operator in (3.13) of Chapter II which is working on f and is based on the Green's function for the heat equation. Thus, according to Theorem 4.28 of TEMME [11, Ch. VI] Fredholm's alternative applies to the integral equation of (13.5) with $n = 2, 3, \dots$ giving the following orthogonality conditions,

$$(13.6) \quad \int_0^{2\pi} \int_0^1 a_n \{ \bar{u}(r, \tau) - \bar{v}(r, \tau) \} dr d\tau +$$

$$\sum_{k=1}^{n-1} \omega_k \int_0^{2\pi} \int_0^1 \left\{ x_{n-k} \frac{\partial \bar{u}}{\partial \tau} + y_{n-k} \frac{\partial \bar{v}}{\partial \tau} \right\} dr d\tau = 0,$$

where $\bar{u}(r, \tau)$ and $\bar{v}(r, \tau)$ are the complex conjugates of $u(r, \tau)$ and $v(r, \tau)$ being the solutions of the adjoint problem

$$(13.7) \quad -\mu \frac{\partial}{\partial \tau} \begin{pmatrix} u \\ v \end{pmatrix} - L_B^* \begin{pmatrix} u \\ v \end{pmatrix} = 0$$

with $u(0) = v(0) = u(1) = v(1)$. The solution has the form

$$(13.8) \quad \begin{pmatrix} u(r, \tau) \\ v(r, \tau) \end{pmatrix} = \begin{pmatrix} 1 \\ \eta \end{pmatrix} e^{i\tau} \sin \pi r$$

$$\eta = -A\sqrt{A^2+1} e^{-i\theta}, \quad \theta = \arcsin(A^2+1)^{-\frac{1}{2}}.$$

Condition (13.6) with $n = 2$ gives $\gamma_1 = \omega_1 = 0$. Using Fourier series expansion we get the solution of (13.5) with $n = 2$; it is of the form

$$(13.9) \quad \begin{pmatrix} x_2(r, \tau) \\ y_2(r, \tau) \end{pmatrix} = \sum_{n=1}^{\infty} \left\{ \begin{matrix} \alpha_n + \alpha_n \cos(2\tau + \psi_n) \\ \beta_n + \beta_n \cos(2\tau + \phi_n) \end{matrix} \right\} \sin n\pi r,$$

where α_n and β_n are identical to the expressions in (12.14). The orthogonality condition (13.6) with $n = 3$ gives γ_2 and ω_2 which in general have values different from zero. Thus, time periodic solutions are found either for $B > B_c$ only or for $B < B_c$ only. AUCHMUTY and NICOLIS [6] also consider the

system (11.3) subjected to boundary conditions different from (11.4). This leads to other types of characteristic solutions.

For example, one may impose no-flux boundary conditions of the type

$$(13.11) \quad x_r(0,t) = y_r(0,t) = x_r(1,t) = y_r(1,t) = 0.$$

For no-flux boundary conditions time periodic bifurcating solutions are found as well. There is, however, a significant difference. In the case (13.10) the time periodic solution is also spatially nonuniform, whereas in the case of no-flux boundary conditions the solution is uniform. The solution then describes a so-called *homogeneous bulk oscillation*. Finally, we mention the possibility of periodic boundary conditions,

$$(13.12) \quad \begin{aligned} x(0,t) &= x(2\pi,t), & y(0,t) &= y(2\pi,t), \\ x_r(0,t) &= x_r(2\pi,t), & y_r(0,t) &= y_r(2\pi,t), \end{aligned}$$

which defines a system on a ring of length 2π . An analysis, similar to the one we made for the system under conditions (13.10), shows that one may expect bifurcating solutions having the form of waves propagating along the ring with a characteristic velocity, see [6].

14. LOCALIZED DISSIPATIVE STRUCTURES

In this section it is assumed that A again varies with r , as in (10.3) we choose

$$(14.1) \quad A(r) = A_0 \frac{\cosh\{2\alpha(r-\frac{1}{2})\}}{\cosh \alpha}, \quad \alpha > 0.$$

Let in (10.7) $D_1 = D$, $D_2 = \nu D$ with $0 < D \ll 1$. Following BOA & COHEN [7] we suppose that the steady state solution of the thermodynamic branch can be expanded as

$$(14.2) \quad X_{\text{eq}}(r) = \sum_{k=0}^{\infty} D^k X_k(r), \quad Y_{\text{eq}}(r) = \sum_{k=0}^{\infty} D^k Y_k(r).$$

Substitution in (10.7) gives after equating the coefficients of equal powers of D a recurrent system of equations for $X_k(r)$ and $Y_k(r)$. Equating the terms independent of D we obtain

$$(14.3) \quad X_0(r) = A(r), \quad Y_0(r) = B/A(r).$$

The functions $X_1(r)$ and $Y_1(r)$ must satisfy

$$(14.4) \quad \begin{aligned} (B-1)X_1 + X_0^2 Y_1 &= - \frac{d^2 X_0}{dr^2}, \\ -BX_1 - X_0^2 Y_1 &= -\nu \frac{d^2 Y_0}{dr^2}. \end{aligned}$$

It is easily verified that the solution of (14.4) reads

$$(14.5) \quad \begin{aligned} X_1(r) &= \frac{d^2 A(r)}{dr^2} + \nu B \frac{d^2}{dr^2} \left(\frac{1}{A(r)} \right), \\ Y_1(r) &= \left\{ -B \frac{d^2 A(r)}{dr^2} - (B-1)\nu B \frac{d^2}{dr^2} \left(\frac{1}{A(r)} \right) \right\} \frac{1}{A^2(r)}. \end{aligned}$$

Similar to (11.2) we write

$$(14.6) \quad \begin{aligned} X(r,t) &= X_{\text{eq}}(r) + x(r,t), \\ Y(r,t) &= Y_{\text{eq}}(r) + y(r,t), \end{aligned}$$

and linearize about $(x,y) = (0,0)$, giving

$$(14.7) \quad \begin{aligned} \frac{\partial x}{\partial t} &= D \frac{\partial^2 x}{\partial r^2} + \{- (B+1) + 2X_{eq}(r) Y_{eq}(r)\}x + X_{eq}^2(r)y \\ \frac{\partial y}{\partial t} &= \nu D \frac{\partial^2 y}{\partial r^2} + \{B - 2X_{eq}(r) Y_{eq}(r)\}x - X_{eq}^2(r)y \end{aligned}$$

Substitution of $(x,y) = (u,v)e^{\lambda t}$ yields

$$(14.8) \quad \begin{aligned} D \frac{d^2 u}{dr^2} + \{- (B+1) + 2X_{eq}(r) Y_{eq}(r)\}u + X_{eq}^2(r)v &= \lambda u, \\ \nu D \frac{d^2 v}{dr^2} + \{B - 2X_{eq}(r) Y_{eq}(r)\}u - X_{eq}^2(r)v &= \lambda v, \end{aligned}$$

with boundary conditions $u(0) = u(1) = v(0) = v(1)$. Contrary to (11.6) this system has variable coefficients, which even may vanish for some r in a certain range of the parameter B . The eigenfunctions of this problem will be analyzed with the WKBJ-method. The solutions are assumed to have the form

$$(14.9) \quad \begin{pmatrix} u(r) \\ v(r) \end{pmatrix} = \exp\left(\frac{iw(r)}{\sqrt{D}}\right) \left\{ \begin{pmatrix} f_0(r) \\ g_0(r) \end{pmatrix} + \sqrt{D} \begin{pmatrix} f_1(r) \\ g_1(r) \end{pmatrix} + D \begin{pmatrix} f_2(r) \\ g_2(r) \end{pmatrix} + \dots \right\}.$$

Substitution in (14.8) gives after equating terms without D

$$(14.10a) \quad \{\lambda + w'(r)^2 + B + 1 - 2X_{eq}(r) Y_{eq}(r)\}f_0 - X_{eq}(r)g_0 = 0,$$

$$(14.10b) \quad \{-B + 2X_{eq}(r) Y_{eq}(r)\}f_0 + \{\lambda + \nu w'(r)^2 + X_{eq}^2(r)\}g_0 = 0,$$

or

$$(14.11) \quad M_\lambda \begin{pmatrix} f_0 \\ g_0 \end{pmatrix} = 0.$$

Equation of the $O(\sqrt{D})$ -terms yields

$$(14.12) \quad M_\lambda \begin{pmatrix} f_1 \\ g_1 \end{pmatrix} = \begin{pmatrix} i\{w''(r)f_0(r) + 2w'(r)f_0'(r)\} \\ \nu i\{w''(r)g_0(r) + 2w'(r)g_0'(r)\} \end{pmatrix}.$$

If $\text{Det } M_\lambda = 0$, that is if

$$\begin{aligned}
(14.13) \quad 2vw'(r)^2 &= - \{v[\lambda+B+1-2X_{eq}(r)Y_{eq}(r)] + \lambda X_{eq}^2(r)\} \\
&\pm [\{v[\lambda+B+1-2X_{eq}(r)Y_{eq}(r)] + \lambda X_{eq}^2(r)\}^2 \\
&- 4v\{\lambda[\lambda+B+1+X_{eq}^2(r)-2X_{eq}(r)Y_{eq}(r)] + X_{eq}^2(r)\}^{\frac{1}{2}}],
\end{aligned}$$

equation (14.11) has a nontrivial solution. It is seen from (14.10) that there exists a constant c such that

$$\frac{\lambda+w'(r)^2+B+1-2X_{eq}(r)Y_{eq}(r)}{B-2X_{eq}(r)Y_{eq}(r)} = \frac{X_{eq}^2(r)}{\lambda+vw'(r)+X_{eq}^2(r)} = c.$$

By adding c times the second equation of (14.12) to the first equation, we obtain

$$(14.14) \quad 0 = w''(r)\{f_0(r)+cv g_0(r)\} + 2w'(r)\{f_0(r)+cv g_0(r)\}'.$$

Integrating this equation once, we obtain

$$(14.15) \quad \{f_0(r) + cv g_0(r)\}\sqrt{w'(r)} = \text{const.}$$

The solution of the system (14.10b), (14.15) is

$$(14.16) \quad g_0(r) = \frac{\text{const}}{\sqrt{w'(r)}} \left\{ cv + \frac{\lambda+vw'(r)+X_{eq}^2(r)}{B-2X_{eq}(r)Y_{eq}(r)} \right\}^{-1}$$

and a similar expression for $f_0(r)$. The constants in f_0 and g_0 are determined by the boundary conditions at $r = 0$. The boundary conditions at $r = 1$ are only satisfied for certain values of λ being the eigenvalues of the problem. If in (14.16) the term between brackets vanishes the leading term of (14.9) becomes singular and the expansion will break down. For the eigenfunctions corresponding with an eigenvalue $\lambda = 0$ this occurs if

$$2vw'(r)^2 + v[B_0+1-2X_{eq}(r)Y_{eq}(r)] + X_{eq}^2(r) = 0,$$

where B_0 is the value of B for which an eigenvalue vanishes. It appears that exactly for this value, the discriminant of (14.13) vanishes, that is when

$$(14.17) \quad [v\{B_0 + 1 - 2X_{eq}(r)Y_{eq}(r) + X_{eq}^2(r)\}^2 = 4vX_{eq}^2(r),$$

or

$$(14.18) \quad B_0 = Q(r;v) + O(\sqrt{D}), \quad Q(r;v) = \{1 - A(r)v^{-\frac{1}{2}}\}^2.$$

Thus, if B_0 is such that (14.18) is satisfied for some r , the asymptotic expansion will not be valid for this value of r . Using (14.1) we see that this happens at two so-called turning-points, r_1 and r_2 , symmetric with respect to $r = \frac{1}{2}$ if B_0 lies between the minimum value

$$B_{\min} = \{1 - A(\frac{1}{2})v^{-\frac{1}{2}}\}^2$$

and the maximum value

$$B_{\max} = \{1 - A_0v^{-\frac{1}{2}}\}^2,$$

as seen in Figure 4a. From formula (14.13) it is deduced that for $r_1 < r < r_2$ the function $w(r)$ is complex so that the term $\exp\{iw(r)\sqrt{D}\}$ of (14.9) is oscillatory. For $r < r_1$ and $r > r_2$, $w'(r)^2$ is negative so that (14.9) is not oscillatory. Thus, within this range of the parameter B the bifurcating steady state shows spatial structure in the center of the domain, see figure 4b. The term *localized dissipative structure* refers to this configuration. If B_0 lies above B_{\max} , the function $w(r)$ is complex across the entire interval $0 \leq r \leq 1$, so that the spatial oscillations are present in the entire interval.

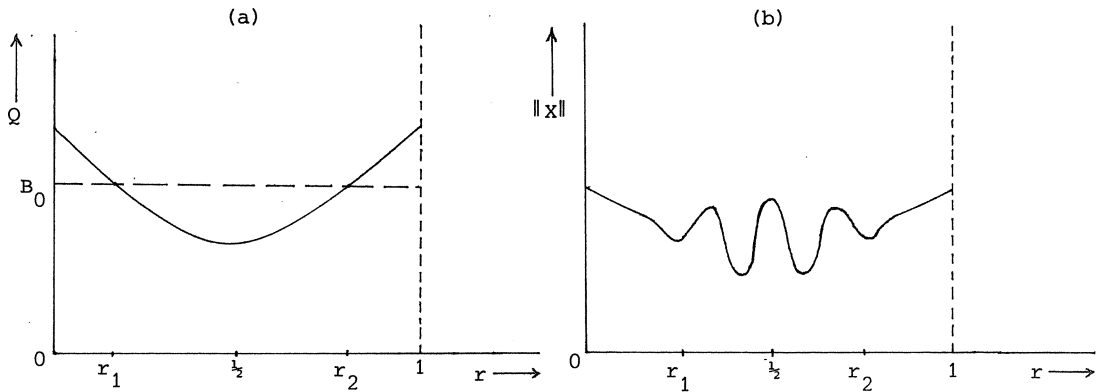

Figure 4. Localized dissipative structure.

15. SOME CONCLUDING REMARKS

The main goal of this chapter was to analyze the mechanism of spatial ordering in an initially uniform chemical system. Using bifurcation theory we have been able to trace certain factors responsible for pattern formation and to obtain a rough classification of the types of dissipative structures that may arise when a parameter of the system crosses a critical value. But before we investigated bifurcation in greater detail, we had to point out why it is worth to put this mathematical effort in the problem.

First of all, the correctness of the mathematical model had to be established. Besides the positivity of the components of the system, we had to investigate the existence of solutions on a semi-infinite time interval, as it is of primary interest to know the behaviour of a solution of this initial-boundary value problem as $t \rightarrow \infty$. In the limit a solution may tend to a stable steady state. In this part of the mathematical analysis the Faedo-Galerkin method plays a crucial role. The analysis of possible steady states depending on the parameter B was carried out in Sections 10 until 12, where also the phenomenon of repeated branching has been discussed. In particular the possibility of secondary bifurcation suggests that this model chemical system could provide us a better insight in the mechanism of morphogenesis. Because of the very nonlinearity, the components can in general not be derived from a potential. Thus, we are working with a model that is not included in Thom's theories of structural stability and morphogenesis [22], which deal with potential systems in which diffusion does not play a role.

In section 14 we considered the case where the reactant A of the system has a nonuniform distribution. This leads to localized dissipative structures for which we employed formal asymptotic techniques, known as the WKBJ-method.

Besides the steady states the system may also have characteristic time dependent solutions. In Section 13 we considered the situation in which bifurcating time periodic solutions occur, which bears a strong similarity with problems in the field of hydrodynamic stability. In an unbounded region one may also expect travelling wave solutions. In this chapter we did not pay any attention to this type of solutions. They also occur in one-component systems as was shown in Chapter IV, where an extensive study of such characteristic solutions of nonlinear diffusion equations has been made.

LITERATURE

- [1] GLANSDORFF, P. & J. PRIGOGINE, *Thermodynamic theory of structure, stability and fluctuations* (Wiley-Interscience, New York, 1971).
- [2] TURING, A.M., *The chemical basis of morphogenesis*, Phil. Trans. Roy. Soc. London B237 (1952) 37-72.
- [3] ROSEN, R., *Dynamical system theory in biology, Volume I* (Wiley-Interscience, New York, 1970).
- [4] AUCHMUTY, J.F.G. & G. NICOLIS, *Bifurcation analysis of non-linear reaction-diffusion equations - I. Evolution equations and the steady state solutions*, Bull. Math. Biology 37 (1975) 323-365.
- [5] LIONS, J.L., *Quelques méthodes de résolution des problèmes aux limites non linéaires* (Dunod & Gauthier - Villars, Paris, 1969).
- [6] AUCHMUTY, J.F.G. & G. NICOLIS, *Bifurcation analysis of reaction diffusion equations - III, Chemical oscillations*. Bull Math. Biology 38 (1976) 325-350.
- [7] BOA, J.A. & D.S. COHEN, *Bifurcation of localized disturbances in a model biochemical reaction*, SIAM J. Appl. Math. 30 (1976), 123-135.
- [8] PROTTER, M.H. & H.F. WEINBERGER, *Maximum principles in differential equations* (Prentice-Hall, Englewood Cliffs, N.J., 1967).
- [9] AGMON, S., *Lectures on elliptic boundary value problems* (Van Nostrand, Princeton, N.J., 1965).
- [10] NEČAS, J., *Les méthodes directes en théorie des équations elliptiques* (Academia, Prague, 1967).
- [11] TEMME, N.M. (ed.), *Nonlinear analysis, Volumes I and II* (Mathematisch Centrum, Amsterdam, 1976).
- [12] TREVES, *Basic linear partial differential equations* (Academic Press, New York, 1975).
- [13] FAEDO, S., *Un nuovo metodo per l'analisi esistenziale e quantitativa dei problemi di propagazione*, Ann. Sc. Norm. Sup. Pisa (1949) 1-40.
- [14] HOPF, E., *Über die Anfangswertaufgabe für die hydrodynamischen Grundgleichungen*, Math. Nachr. 4 (1951) 213-231.

- [15] HALE, J.K., *Ordinary differential equations* (Wiley-Interscience, New York, 1969).
- [16] BROWN, A.L. & A. PAGE, *Elements of functional analysis*, (Van Nostrand Rheinhold, London, 1970).
- [17] STAKGOLD, I., *Boundary value problems of mathematical physics, I*, (MacMillan, New York, 1967).
- [18] SATTINGER, D.H., *Topics in stability and bifurcation theory* Lecture Notes in Mathematics 309, Springer-Verlag Berlin, 1973.
- [19] MAHAR, T.J., & B.J. MATKOWSKY, *A model biochemical reaction exhibiting secondary bifurcation*. To appear.
- [20] JOSEPH, D.D., & D.H. SATTINGER, *Bifurcating time periodic solutions and their stability* Arch. Rat. Mech. Anal. 45 (1972) 79-109.
- [21] IOOSS, G., *Esistence et stabilité de la solution périodique secondaire intervenant dans les problèmes d'évolution du type Navier-Stokes*, Arch. Rat. Mech. Anal. 47 (1972) 301-329.
- [22] THOM, R., *Stabilité structurelle et morphogenese*, (Benjamin Press Reading (Mass.), 1972).
- [23] WEINBERGER, H.F., *Invariant sets for weakly coupled parabolic and elliptic systems*, Rend. d. Matem. 8 (1975) 295-310.

VII. NERVE AXON EQUATIONS

1. INTRODUCTION

In chapter IV we have studied a diffusion equation with a nonlinear source term (see Chapter IV (1.1)) and we observed some qualitative similarity with the phenomenon of nerve impulse propagation. By constructing better adapted models for describing the conduction of electrical impulses in a nerve axon, one arrives at *systems* of diffusion equations with nonlinear source terms. The basic model in this field is the famous Hodgkin-Huxley model [1]. Hodgkin and Huxley described the state of a nerve axon by a function $u = u(x,t)$, the electrical potential over a membrane. This membrane separates the core of the axon from the surrounding medium, which both are fluids containing metallic ions, sodium (Na^+) and potassium (K^+). This gives rise to currents either through the membrane or longitudinally along the axon. The nonlinearity of this theory appears through the terms describing the permeability of the membrane to the different types of ions.

The system can be written in the form

$$\frac{\partial^2 u}{\partial x^2} = \frac{\partial u}{\partial t} + I(u,w), \quad (1.1)$$

$$\frac{\partial w}{\partial t} = P(u)w + q(u),$$

where $u = u(x,t)$ is the electrical potential across the membrane and $w = w(x,t)$ is a three-dimensional vector function, of which the components determine the permeability of the membrane to the specific ions. The 3×3 matrix function $P(u)$ and the vector function $q(u)$ depend nonlinearly on u , and the scalar $I(u,w)$ is linear in u , but nonlinear in w . One can study (1.1) both on the half plane $-\infty < x < \infty$, $t \geq 0$ or on the quarter plane $x \geq 0$, $t \geq 0$. In this chapter we will study a simplified version of this system, known as the FitzHugh-Nagumo system which takes the form (except for $\gamma > 0$ equivalent to a form given by NAGUMO et al. [2])

$$\frac{\partial u}{\partial t} = \frac{\partial^2 u}{\partial x^2} + u(1-u)(u-a) - bv, \quad 0 < a < 1, b > 0, \quad (1.2)$$

$$\frac{\partial v}{\partial t} = -\gamma v + u, \quad \gamma \geq 0.$$

Once more, u means the voltage, while the scalar v represents a variable combining two components of the vector function w of (1.1). The parameter b should be considered small, as follows from the transition from (1.1) to (1.2) (for details see CASTEN et al. [3]). The basic arguments of the transformation leading to (1.2) are supplied by the physical observable difference in time-scales, by which the components of the vector function w are acting in (1.1). It should be noted that the case $\gamma = 0$ gives rise to a situation which is mathematically a little simpler. But some people argue that the term $-\gamma v$ should be retained in the equations on physical grounds. In this chapter we will mention some properties of (1.2) with only an indication of the proofs omitting all details.

First we discuss what we should expect from a mathematical model for nerve axon conduction on the ground of some known characteristics of nerve axons, found by experiments on living axons.

- (a) If the dependence of the voltage on the position along the axon is removed, an impulse can be stimulated simultaneously at every point: the so-called space-clamped experiment. An impulse will arise only if the stimulating current or voltage reaches a threshold value. When this occurs the voltage firstly continues to rise, without further input and then it falls down to a small negative value before returning to the equilibrium state.
- (b) If one supplies a boundary condition in the form of a persisting signal at the end of the axon, this signal must reach a threshold value in order that a signal results, which then propagates with a constant velocity and with the shape found by the experiment under (a) along the axon.
- (c) In view of (b) it is reasonable to expect the existence of a travelling wave $u(x,t) = \phi(\xi)$, $v(x,t) = \psi(\xi)$, $\xi = x + ct$, with conditions $\phi(\pm\infty) = \psi(\pm\infty) = 0$, where $(u,v) = (0,0)$ represents the unique rest state.
- (d) The information transferred by the axon may be richer than only a signal indicating the activation of the cell body of the nerve (all or nothing). Variations like the time intervals between pulses or the frequency of pulse trains may form a code for the receiving system. It is preferable that our model reflects this feature. The axon on which Hodgkin and Huxley made their experiments, the squid axon, does not display this variation however, probably because this particular axon does not need to transmit this kind of information.
- (e) The ionic concentrations in which the nerve axon acts can be altered by adding other chemicals with the effect that the shape of the travelling wave changes or even that there no longer exists a travelling wave. This

should be reflected by the effect of changes of the appropriate parameters in the model.

Most of these characteristics are indeed found for the Hodgkin-Huxley system by numerical analysis. Since the FitzHugh-Nagumo system (1.2) has only two dependent variables there is some hope that the question whether or not it has the required properties can be answered by mathematical analysis. The rest of this chapter is devoted to this approach. This chapter is based on an article by HASTINGS [4].

2. THE FITZHUGH-NAGUMO SYSTEM

The FitzHugh-Nagumo system resembles to some extent the problem, which we have studied in Sections IV. 4 and IV. 5. The only difference is the variable v , which we have called there, anticipating this chapter, the recovery-variable, because this variable achieves the desired effect that the voltage, resulting from a stimulus above threshold, will return to the rest state. This feature does not occur in the model of Chapter IV, for which we proved that $\lim_{t \rightarrow \infty} u(x,t) = 1$ on each bounded x -interval, if the initial data are above a certain level (see Theorem IV. 4.4 and IV. 5.4). Intuitively we see from (1.2) that indeed v acts as a variable controlling the growth of u .

We will examine the properties of the solution (u,v) of (1.2).

2.1. Space-clamped solutions

By assuming the space-independence of the physical situation and stimulating the axon with a constant current I , we find

$$\frac{\partial u}{\partial t} = I + u(1-u)(u-a) - bv, \quad (2.1)$$

$$\frac{\partial v}{\partial t} = -\gamma v + u,$$

where I may be zero. If we put the condition

$$(1+a)^2 \left(a + \frac{b}{\gamma}\right)^2 - 4I(1+a)^3 - 4\left(a + \frac{b}{\gamma}\right)^3 + 18I(1+a) \left(a + \frac{b}{\gamma}\right) - 27I^2 < 0, \quad (2.2)$$

then we are assured that there exists precisely one equilibrium point (u_0, v_0) , depending on I ; in particular for $I = 0$ (2.2) means

$$(2.3) \quad (1-a)^2 < \frac{4b}{\gamma}.$$

Linearizing around the point (u_0, v_0) , yields with $\bar{u} = u - u_0$, $\bar{v} = v - v_0$,

$$(2.4) \quad \frac{d}{dt} \begin{pmatrix} \bar{u} \\ \bar{v} \end{pmatrix} = \begin{pmatrix} -3u_0^2 + 2(1+a)u_0 - a & -b \\ 1 & -\gamma \end{pmatrix} \begin{pmatrix} \bar{u} \\ \bar{v} \end{pmatrix}.$$

For $I = 0$ it follows that the eigenvalues of the matrix have negative real parts. So the equilibrium point is asymptotically stable. By further examination we can determine the character of this point (see Chapter IV. 2).

For $I = 0$ it follows that

$$(2.5) \quad \begin{aligned} (u_0, v_0) = (0, 0) \text{ is a spiral point if } (a-\gamma)^2 < 4b \\ (u_0, v_0) = (0, 0) \text{ is a two-tangent node if } (a-\gamma)^2 > 4b. \end{aligned}$$

The basic experiment of stimulating a resting axon with a brief pulse corresponds to an initial value problem for (2.1) with $I = 0$, $u(0) > 0$, $v(0) = 0$. In the (u, v) -plane it corresponds to trajectories starting with $u(0) < a$, or $u(0) > a$. If $u(0) < a$ then $u' < 0$ while for $u(0) > a$ we have $u' > 0$. It can further be shown that there are no periodic orbits and that $(0, 0)$ is globally stable (see MCKEAN [5]). In Fig. 1 some trajectories are sketched.

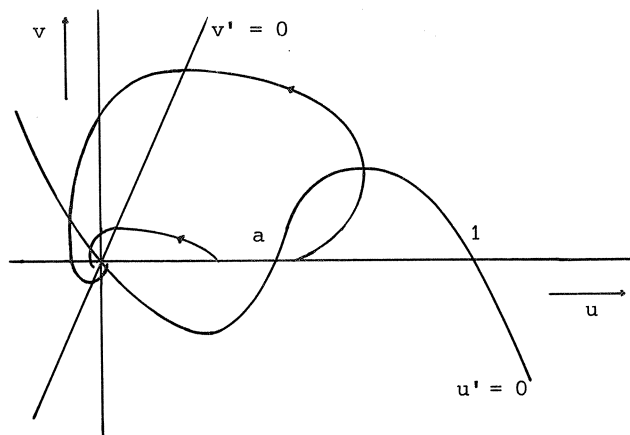

Figure 1

So (2.1) with $I = 0$ exhibits a mathematical version of the threshold character, with $u(0) = a$ representing the threshold value.

If we now let vary the value I to positive values, the phase portrait for I near 0 will be qualitatively the same. For some values of the parameters and some value $I = I_1$ the eigenvalues of the linearized problem will be purely imaginary, and for $I_1 < I < I_2$ the eigenvalues have positive real parts. Such a change is usually accompanied by the arise of periodic solutions, the so-called Hopf bifurcation of a family of periodic solutions from equilibrium. Until yet, this phenomenon has not been detected experimentally; small amplitude oscillations are however recorded by numerical simulations of the Hodgkin-Huxley system (see HASTINGS [4] for further references).

2.2. Travelling waves

In view of the results of experiments, mentioned under (b) in the introduction, a major part of research in this field was dedicated to the proof of the existence of a travelling wave for (1.2). It means that there exists a solution (u,v) of (1.2) which travels along the axon with a fixed shape and speed: u,v depend only on $\xi = x + ct$. Let ' denote differentiation with respect to ξ , then (1.2) can be written as

$$(2.6) \quad \begin{aligned} u' &= w, \\ w' &= cw - u(1-u)(u-a) + bv, \\ v' &= \frac{1}{c} u, \end{aligned}$$

where we have chosen $\gamma = 0$. Our purpose is the determination of values for the up to now arbitrary constant c such that (2.6) has a nontrivial solution satisfying $u(\pm\infty) = 0$, and the same for $w(\xi)$ and $v(\xi)$: a so-called homoclinic orbit. Since the space is now 3-dimensional we cannot use the Poincaré-Bendixson theory and the analysis will be more intricate. The only equilibrium point in the (u,w,v) -space is $(0,0,0)$. Linearizing around this point gives $y' = Ay$, with $y = (u,w,v)^T$ and

$$(2.7) \quad A = \begin{pmatrix} 0 & 1 & 0 \\ a & c & b \\ 1/c & 0 & 0 \end{pmatrix}.$$

The eigenvalues of A determine the local behaviour of the full system near

(0,0,0): there is one positive eigenvalue λ_1 and two eigenvalues with negative real part.

This can be seen from the relations:

$$(i) \quad \lambda_1 + \lambda_2 + \lambda_3 = c > 0$$

$$(ii) \quad \lambda_1\lambda_2 + \lambda_1\lambda_3 + \lambda_2\lambda_3 = -a < 0$$

$$(iii) \quad \lambda_1\lambda_2\lambda_3 = b/c > 0.$$

Since λ_i satisfies $\lambda^3 - c\lambda^2 - a\lambda - b/c = 0$, it follows immediately that λ_1 is real and positive and $\lambda_2\lambda_3 > 0$. Both for $\lambda_2 = \bar{\lambda}_3$ or $\lambda_2 \neq \bar{\lambda}_3$ (which implies λ_2 and λ_3 real) it follows that $\text{Re}\lambda_2 < 0$ and $\text{Re}\lambda_3 < 0$. For the linear system the general solution is

$$(2.8) \quad y(\xi) = \sum_{i=1}^3 \alpha_i p^i e^{\lambda_i \xi},$$

with α_i arbitrary and p^i the eigenvector corresponding to the eigenvalue λ_i . If $\alpha_i = 0$ then it follows that $\lim_{\xi \rightarrow \infty} y(\xi) = 0$, while if $\alpha_2 = \alpha_3 = 0$ $\lim_{\xi \rightarrow -\infty} y(\xi) = 0$. The transition from the linear to the nonlinear system will not affect the behaviour near (0,0,0). In view of the stable manifold theorem (see section IV. 2.1) we know that there exists a two-dimensional stable manifold S and a one-dimensional unstable manifold U both containing (0,0,0) in their interior. S divides U in two parts U^+ and U^- . Since the system depends on c as a parameter we denote this by the subscript c . Our purpose is to find c such that U_c bends around and intersects the stable manifold S which implies that for certain initial vectors $y(0)$, $\lim_{\xi \rightarrow -\infty} y(\xi) = \lim_{\xi \rightarrow \infty} y(\xi) = 0$. We will mention some results which were proved by Hastings by a detailed analysis of the phase space.

THEOREM 2.1. *If $\frac{1}{2} \leq a < 1$ then all solutions $y(\xi) = (u(\xi), w(\xi), v(\xi))$ of (2.6), which intersect the unstable manifold U_c , are unbounded.*

THEOREM 2.2. *Let $0 < a < \frac{1}{2}$, and $0 < b < b_1$, b_1 sufficiently small, then there are numbers c_1, c_2 depending on a and b and with $c_2 > c_1$ such that (2.6) has a homoclinic orbit for $c = c_1$ and $c = c_2$ and periodic orbits for $c_1 < c < c_2$.*

Theorem 2.2 is the result of three papers [6,7,8] and contains at the moment the most definite results.

PROOF OF THEOREM 2.1. In order that the solution will show the limit

behaviour $\lim_{\xi \rightarrow -\infty} y(\xi) = 0$ it is necessary that $y(0)$ lies on the unstable manifold, either on U^+ or on U^- . We note that for the eigenvector $p^1 = (p_1^1, p_2^1, p_3^1)$ holds by direct examination $p_1^1 > 0$, $p_2^1 > 0$, $p_3^1 > 0$. So let $y(0)$ lie either in the positive octant (on U^+) or in the negative octant (on U^-). The last possibility is easily excluded since then it follows from (2.6) that all components are decreasing, since all derivatives remain negative. We will prove that if $y(0)$ lies on U^+ , u and v remain positive and since $u' = w$, it follows that u becomes unbounded, if we can prove that $w > 0$ for all ξ . Define

$$(2.9) \quad \psi(\xi) = \frac{1}{2} w^2(\xi) + F(u(\xi)), \quad F(u) = \int_0^u f(u') du'.$$

Differentiating (2.9) we get

$$(2.10) \quad \psi'(\xi) = cw^2(\xi) + bw(\xi)v(\xi).$$

So $\psi' > 0$ if $w > 0$ and $v > 0$. Further u remains positive if w remains positive and v remains positive if u remains positive. Thus the crucial role will be played by w . Starting at $\xi = -\infty$, $y(-\infty) = 0$ and $\psi(-\infty) = 0$ so $\psi > 0$ and $\psi' > 0$ as long as $w > 0$; $\psi' > 0$ implies $\frac{1}{2} w^2 > -F(u)$, while $-F(u) \geq 0$ for the given values of a . Let $\bar{\xi}$ be the first value for which $w(\bar{\xi}) = 0$ then $\psi(\bar{\xi}) = F(u(\bar{\xi})) \leq F(u(-\infty)) = \psi(-\infty) = 0$. It implies that $\psi'(\xi) = 0$ for some $\xi_0 < \bar{\xi}$, a contradiction since $w(\xi_0) > 0$. \square

Thus a necessary condition on $f(u)$ such that (2.6) has a homoclinic orbit is $0 < a < \frac{1}{2}$, which implies $\int_0^1 f(u) du > 0$. We will prove a lemma that gives us an idea how the existence of a homoclinic orbit is proved. We denote the unstable manifold from $(0,0)$ by $U_{c,b}$ and the corresponding y by $y_{c,b}$, stressing the dependence on the parameters c and b .

LEMMA 2.3. *Let $0 < a < \frac{1}{2}$ and b sufficiently small, then there exists a c_1 such that the projection of $U_{c_1,b}^+$ on $v = 0$ tends to infinity in*

$$R^- = \{(u,w) \mid u < 0, w < 0\}.$$

There is also a c_2 , $c_2 > c_1$ such that the projection of $U_{c_2,b}^+$ on $v = 0$ tends to infinity in

$$R^+ = \{(u,w) \mid u > 0, w > 0\}.$$

PROOF. Putting $b = c = 0$ we arrive at the equation we have examined in Chapter IV. The solution with $y(-\infty) = 0$ lies in the plane $v = 0$ and since $0 < a < \frac{1}{2}$ we find the solution $u = \phi(\xi)$ with ϕ defined in section IV. 4.1. Let now c have a small positive value, then we know from the proof of Theorem IV. 4.8 that the unstable manifold $U_{c,0}^+$ will lie close to the curve $\frac{1}{2}(\phi')^2 + F(\phi) = 0$ and will cross the negative v -axis, thus the corresponding $u_{c,0}, w_{c,0}$, fixed by $(u_{c,0}(0), w_{c,0}(0))$ as the point of crossing of the positive u -axis, tend to minus infinity. So there is a ξ_0 such that

$$(2.11) \quad u_{c,0}(\xi_0) < 0, \quad w_{c,0}(\xi_0) < 0.$$

Fix $c = c_1$ and let b be positive, then we can choose b so small that

$$(2.12) \quad c_1 w_{c_1,b}(\xi_0) < -b \int_{-\infty}^{\xi_0} u_{c_1,b}(\xi')/c_1 \, d\xi'.$$

Thus $c_1 w_{c_1,b}(\xi_0) < -b v_{c_1,b}(\xi_0)$ and $w'_{c_1,b}(\xi_0) = c_1 w_{c_1,b}(\xi_0) - f(u_{c_1,b}(\xi_0)) + b v_{c_1,b}(\xi_0) < -f(u_{c_1,b}(\xi_0)) < 0$, since $u_{c_1,b}(\xi_0) < 0$. So $u'_{c_1,b}(\xi_0), w'_{c_1,b}(\xi_0)$ and $v'_{c_1,b}(\xi_0)$ are negative and even $u'''_{c_1,b}(\xi_0) = w''_{c_1,b}(\xi_0) = c_1 w'_{c_1,b}(\xi_0) - f'(u_{c_1,b}(\xi_0))u'_{c_1,b}(\xi_0) + b v'_{c_1,b}(\xi_0) < 0$, since $f'(u) < 0$ for $u < 0$. So (u, u', u'') remains in the negative octant and so does the solution (u, w, v) .

The second part of the lemma follows from the fact that for $b = 0$ and $c = c_H = \frac{1}{2}\sqrt{2} - a/2$ the unstable manifold from $(0,0)$ $U_{c_H,0}^+$ represents the unique front, with $u(-\infty) = 0, u(\infty) = 1$ (see Theorem IV. 4.5; note that now $\xi = x + ct$), and for $c > c_H$ $U_{c,0}^+$ will be unbounded. The possibility that $U_{c,0}^+$ should cross the positive w -axis is excluded by $u' = w$ and the possibility that $U_{c,0}^+$ should cross the u -axis is excluded because $U_{c,0}^+$ cannot cross $U_{c_H,0}^+$ and the direction of $U_{c,0}^+$ at $(0,0)$ is greater than the direction of $U_{c_H,0}^+$ at $(0,0)$. If $b > 0$ then v remains positive as long as u is positive; it means $w' = u'' = cu' - f(u) + bv > cu' - f(u)$. So the projection of $U_{c,b}^+$ on the (u,w) -plane will lie above the manifold $U_{c,0}^+$ and so the assertion of the lemma is proved. \square

We now define the sets A, B_+ and B_-

$$A = \{c \mid U_{c,b}^+ \text{ is unbounded}\}$$

$$B_{\pm} = \{c \mid \text{projection of } U_{c,b}^+ \text{ on } v = 0 \text{ tends to infinity in } \mathbb{R}^{\pm}\}.$$

If we prove that $A = B_+ \cup B_-$ we have eliminated the possibility of unbounded oscillating solutions. B_+ and B_- are not empty by Lemma 2.3 and are disjoint

and by proving that B_+ and B_- are open it follows that $A = B_+ \cup B_- \neq (0, \infty)$. Take a value c in the complement A^c of A then we are assured that $U_{c,b}^+$ is bounded. By refinements of the proofs needed for these assertions, it is actually possible to prove that A^c contains an interval (c_1, c_2) , $c_2 > c_1 > 0$ such that c_1, c_2 yield homoclinic orbits and values in between periodic solutions. We refer to HASTINGS [7,8].

Now that we are assured of the existence of a travelling wave, which we call $u = \phi(\xi)$, the following result makes sense.

THEOREM 2.4. *For a travelling wave $u = \phi(\xi)$ the speed c satisfies*

$$(2.13) \quad c^2 > \frac{4b}{(1-a)^2}.$$

Moreover $\phi(\xi)$ has at least one zero and

$$(2.14) \quad \max_{-\infty < \xi < \infty} \phi(\xi) > \frac{1-a}{2} - \frac{1}{2} \left\{ (1-a)^2 - \frac{4b}{c^2} \right\}^{\frac{1}{2}}.$$

For the proof we refer to GREEN & SLEEMAN [10]. They used energy-like integrals and a convexity argument. We note that from (2.14) it follows that $\max_{-\infty < \xi < \infty} \phi(\xi) > a$, indicating the threshold character of this parameter.

From extensive numerical experiments it has been conjectured that the two values c_1, c_2 with $c_2 > c_1 > 0$ are such that for fixed $a, c_1(a,b)$ is increasing in b , $c_2(a,b)$ is decreasing in b and that $c_2 < c_H = \frac{1}{2} \sqrt{2 - a\sqrt{2}}$ for all values of b for which the corresponding homoclinic orbit exists (see MCKEAN [5]). For a further introduction to this system we refer to HASTINGS [4] and MCKEAN [5]. The methods by which Hastings has proved existence of homoclinic and periodic orbits for the FitzHugh-Nagumo system, are also applied by him to the Hodgkin-Huxley system [9].

We mention also recent work of SATTINGER [11] on the stability of travelling waves with methods of functional analysis, and of RAUCH & SMOLLER [12] on the existence of a solution of the initial value problem and on the asymptotic behaviour, thereby using the technique of the so-called contracting rectangles R : if $(u(x,0), v(x,0))$ lies in R for all $x \in \mathbb{R}$, then $(u(x,t), v(x,t))$ lies in R for all $t \geq 0$ and $x \in \mathbb{R}$; R is an invariant set for the system (1.2). EVANS [13] studies general nerve axon equations and examines especially the stability.

LITERATURE

- [1] HODGKIN, A.L. & A.F. HUXLEY, *A quantitative description of membrane current and its application to conduction and excitation in nerve*, J. Physiol. 117 (1952) 500-544.
- [2] NAGUMO, J., S. ARIMOTO & S. YOSHIZAWA, *An active pulse transmission line simulating nerve action*, Proc. IRE 50 (1962) 2061-2070.
- [3] CASTEN, R., H. COHEN & P. LAGERSTROM, *Perturbation analysis of an approximation to Hodgkin-Huxley theory*, Quart. Appl. Math. 32 (1975) 365-402.
- [4] HASTINGS, S.P., *Some mathematical problems from neurobiology*, Am. Math. Monthly 82 (1975) 881-895.
- [5] MCKEAN, H.P., *Nagumo's Equation*, Advances in Mathematics 4 (1970) 209-223.
- [6] HASTINGS, S.P., *On a third order differential equation from biology*, Quart. J. Math. 23 (1972) 435-448.
- [7] HASTINGS, S.P., *The existence of periodic solutions to Nagumo's equation*, Quart. J. Math. 25 (1974) 369-378.
- [8] HASTINGS, S.P., *On the existence of homoclinic and periodic orbits for the FitzHugh-Nagumo equations*, Quart. J. Math. 27 (1976) 123-134.
- [9] HASTINGS, S.P., *On travelling wave solutions of the Hodgkin-Huxley equations*, Arch. Rational Mech. Anal. 60 (1976) 229-258.
- [10] GREEN, M.W. & B.D. SLEEMAN, *On FitzHugh's nerve axon equations*, J. Math. Biology 1 (1974) 153-163.
- [11] SATTINGER, D.H., *On the stability of waves of nonlinear parabolic systems*, Advances in Mathematics 22 (1976) 312-355.
- [12] RAUCH, J. & J. SMOLLER, *Qualitative theory of the FitzHugh-Nagumo equations*, Advances in Mathematics 27 (1978) 12-44.
- [13] EVANS, J.W., *Nerve axon equations I. Linear approximations*, Ind. Univ. Math. J. 21 (1972) 877-885; II. *Stability at rest*, idem 22 (1972) 75-90; III. *Stability of the nerve impulse*, idem 22 (1972) 577-593; IV. *The stable and unstable impulse*, idem 24 (1975) 1169-1190.

REFERENCES

Numbers refer to chapters, especially to the list of Literature at the end of each chapter

AGMON, S.	II, VI
AGMON, S., A. DOUGLIS & L. NIRENBERG	III
ANDRONOV, A.A. & E.A. LEONTOVICH, I.I. GORDON & A.G. MAIER	IV
ARONSON, D.G. & H.F. WEINBERGER	I, IV
AUCHMUTY, J.F.G.	V
AUCHMUTY, J.F.G. & G. NICOLIS	VI
BOA, J.A. & D.S. COHEN	VI
BROWN, A.L. & A. PAGE	VI
CASTEN, R., H. COHEN & P. LAGERSTROM	VII
CHAFEE, N.	I, IV, V
CHAFEE, N. & E.F. INFANTE	V
CODDINGTON, E.A. & N. LEVINSON	I, IV, V
COHEN, D.S.	I
COHEN, H.	I
COOLEN, T.M.T., G.J.R. FÖRCH, E.M. de JAGER & H.G.J. PIJLS	III
COURANT, R. & D. HILBERT	III
DOUGLIS, A. & L. NIRENBERG	III
EVANS, J.W.	VII
FAEDO, S.	VI
FIFE, P.C. & J.B. MCLEOD	IV
FISHER, R.A.	I, IV
FITZHUGH, R.	I
FLEMING, W.H.	I
FRIEDMAN, A.	IV
GELFAND, I.M., & S.V. FOMIN	I
GREEN, M.W. & B.D. SLEEMAN	VII
GROESEN, E.W.C., van	I
HADELER, K.P. & F. ROTHE	IV
HALE, J.K.	IV, V, VI
HASTING, S.P.	I, VII
HOPF, E.	VI

IOOSS, G.	VI
JOSEPH, D.D. & D.H. SATTINGER	VI
KANEL', Ja.I.	IV
KOLMOGOROFF, A., I. PETROVSKY & N. PISCOUNOFF	I, II, IV
LADYŽENSKAJA, O.A., V.A. SOLONNIKOV & N.N. URAL'CEVA	II, III
LIONS, J.L.	II, VI
MAHAR, T.J. & B.J. MATKOWSKY	VI
McKEAN, H.P.	VII
MORREY Jr, C.B.	III
NAGUMO, J., S. ARIMOTO & S. YOSHIZAWA	I
NEČAS, J.	II, VI
PELETIER, L.A.	V
PROTTER, M.H. & H.F. WEINBERGER	II, III, VI
RAUCH, J. & J. SMOLLER	VII
ROSEN, R.	I, VI
ROTHE, F.	IV
LA SALLE, J.P. & S. LEFSCHETZ	I
SATTINGER, D.H.	III, IV, VI, VII
SCHWARTZ, L.	II
STAKGOLD, I.	VI
TEMME, N.M.	I, II, III, IV, VI
THOM, R.	VI
TREVES, F.	III, VI
TURING, A.M.	I, VI
WEINBERGER, H.F.	VI
WILLEMS, G.M. & H.C. HEMKER	I, V
WLOKA, J.	II, III

GENERAL INDEX

Asymptotically stable	11, 144
attractive	144
Bounded operator	63
branch (of solutions)	207
Center	90
chemical system	165
classical solution	54
compact operator	64
continuous operator	63
critical wave number	216
Dirichlet integral	187
dissipative structure	165, 216
distributional solution	43
domain of attraction	85, 144
dynamical system	141
Equilibrium (point)	7, 143
FitzHugh-Nagumo system	233
focus	90
front	85
Genotypes	5
Heteroclinic trajectory	5
Hodgkin-Huxley model	2, 233
Hölder continuity	39
Hölder spaces	39
homoclinic trajectory	3
Huxley pulse	99
Invariant manifold	89
invariant set	141
isolated equilibrium (point)	12, 143

Linearly (un)stable	215
Lipschitz continuity	39
lower (equilibrium) solution	69, 147
Lyapunov function(al)	11, 143
Main direction (of a node)	89
maximum principle	
one-dimensional	26
for the Laplace equation	29
for one-dimensional parabolic equations	32
for uniformly strongly elliptic operators	62
morphogenesis	4, 170
Node	89
Open system	165
orbit	141
Positively invariant set	141
Reaction-diffusion problem	4, 166
Saddle point	88
separatrices	89
side direction (of a node)	89
Sobolev lemma	42
Sobolev spaces	40
speed (of a front)	85
spiral point	90
stable	8, 144
stable manifold	89
stabilize	12, 143
steady state	165
Travelling front	85
travelling wave (solution)	2, 237
tree (of solutions)	207

Uniformly parabolic operator	175
uniformly strongly elliptic	62
uniform steady state	165
unstable	11, 145
unstable manifold	89
upper (equilibrium) solution	69, 147
Weak derivative	39
weakly coupled	175
weak solution	188
ω -limit set	141

UITGAVEN IN DE SERIE MC SYLLABUS

Onderstaande uitgaven zijn verkrijgbaar bij het Mathematisch Centrum,
2e Boerhaavestraat 49 te Amsterdam-1005, tel. 020-947272.

- MCS 1.1 F. GÖBEL & J. VAN DE LUNE, *Leergang Besliskunde, deel 1: Wiskundige basiskennis*, 1965. ISBN 90 6196 014 2.
- MCS 1.2 J. HEMELRIJK & J. KRIENS, *Leergang Besliskunde, deel 2: Kansberekening*, 1965. ISBN 90 6196 015 0.
- MCS 1.3 J. HEMELRIJK & J. KRIENS, *Leergang Besliskunde, deel 3: Statistiek*, 1966. ISBN 90 6196 016 9.
- MCS 1.4 G. DE LEVE & W. MOLENAAR, *Leergang Besliskunde, deel 4: Markovketens en wachttijden*, 1966. ISBN 90 6196 017 7.
- MCS 1.5 J. KRIENS & G. DE LEVE, *Leergang Besliskunde, deel 5: Inleiding tot de mathematische besliskunde*, 1966. ISBN 90 6196 018 5.
- MCS 1.6a B. DORHOUT & J. KRIENS, *Leergang Besliskunde, deel 6a: Wiskundige programmering 1*, 1968. ISBN 90 6196 032 0.
- MCS 1.6b B. DORHOUT, J. KRIENS & J.TH. VAN LIESHOUT, *Leergang Besliskunde, deel 6b: Wiskundige programmering 2*, 1977. ISBN 90 6196 150 5.
- MCS 1.7a G. DE LEVE, *Leergang Besliskunde, deel 7a: Dynamische programmering 1*, 1968. ISBN 90 6196 033 9.
- MCS 1.7b G. DE LEVE & H.C. TIJMS, *Leergang Besliskunde, deel 7b: Dynamische programmering 2*, 1970. ISBN 90 6196 055 X.
- MCS 1.7c G. DE LEVE & H.C. TIJMS, *Leergang Besliskunde, deel 7c: Dynamische programmering 3*, 1971. ISBN 90 6196 066 5.
- MCS 1.8 J. KRIENS, F. GÖBEL & W. MOLENAAR, *Leergang Besliskunde, deel 8: Minimamethode, netwerkplanning, simulatie*, 1968. ISBN 90 6196 034 7.
- MCS 2.1 G.J.R. FÖRCH, P.J. VAN DER HOUWEN & R.P. VAN DE RIET, *Colloquium Stabiliteit van differentieschema's, deel 1*, 1967. ISBN 90 6196 023 1.
- MCS 2.2 L. DEKKER, T.J. DEKKER, P.J. VAN DER HOUWEN & M.N. SPIJKER, *Colloquium Stabiliteit van differentieschema's, deel 2*, 1968. ISBN 90 6196 035 5.
- MCS 3.1 H.A. LAUWERIER, *Randwaardeproblemen, deel 1*, 1967. ISBN 90 6196 024 X.
- MCS 3.2 H.A. LAUWERIER, *Randwaardeproblemen, deel 2*, 1968. ISBN 90 6196 036 3.
- MCS 3.3 H.A. LAUWERIER, *Randwaardeproblemen, deel 3*, 1968. ISBN 90 6196 043 6.
- MCS 4 H.A. LAUWERIER, *Representaties van groepen*, 1968. ISBN 90 6196 037 1.

- MCS 5 J.H. VAN LINT, J.J. SEIDEL & P.C. BAAYEN, *Colloquium Discrete wiskunde*, 1968. ISBN 90 6196 044 4.
- MCS 6 K.K. KOKSMA, *Cursus ALGOL 60*, 1969. ISBN 90 6196 045 2.
- MCS 7.1 *Colloquium Moderne rekenmachines, deel 1*, 1969. ISBN 90 6196 046 0.
- MCS 7.2 *Colloquium Moderne rekenmachines, deel 2*, 1969. ISBN 90 6196 047 9.
- MCS 8 H. BAVINCK & J. GRASMAN, *Relaxatietrillingen*, 1969. ISBN 90 6196 056 8.
- MCS 9.1 T.M.T. COOLEN, G.J.R. FÖRCH, E.M. DE JAGER & H.G.J. PIJLS, *Elliptische differentiaalvergelijkingen, deel 1*, 1970. ISBN 90 6196 048 7.
- MCS 9.2 W.P. VAN DEN BRINK, T.M.T. COOLEN, B. DIJKHUIS, P.P.N. DE GROEN, P.J. VAN DER HOUWEN, E.M. DE JAGER, N.M. TEMME & R.J. DE VOGELAERE, *Colloquium Elliptische differentiaalvergelijkingen, deel 2*, 1970. ISBN 90 6196 049 5.
- MCS 10 J. FABIUS & W.R. VAN ZWET, *Grondbegrippen van de waarschijnlijkheidsrekening*, 1970. ISBN 90 6196 057 6.
- MCS 11 H. BART, M.A. KAASHOEK, H.G.J. PIJLS, W.J. DE SCHIPPER & J. DE VRIES, *Colloquium Halfalgebra's en positieve operatoren*, 1971. ISBN 90 6196 067 3.
- MCS 12 T.J. DEKKER, *Numerieke algebra*, 1971. ISBN 90 6196 068 1.
- MCS 13 F.E.J. KRUSEMAN ARETZ, *Programmeren voor rekenautomaten; De MC ALGOL 60 vertaler voor de EL X8*, 1971. ISBN 90 6196 069 X.
- MCS 14 H. BAVINCK, W. GAUTSCHI & G.M. WILLEMS, *Colloquium Approximatiethorie*, 1971. ISBN 90 6196 070 3.
- MCS 15.1 T.J. DEKKER, P.W. HEMKER & P.J. VAN DER HOUWEN, *Colloquium Stijve differentiaalvergelijkingen, deel 1*, 1972. ISBN 90 6196 078 9.
- MCS 15.2 P.A. BEENTJES, K. DEKKER, H.C. HEMKER, S.P.N. VAN KAMPEN & G.M. WILLEMS, *Colloquium Stijve differentiaalvergelijkingen, deel 2*, 1973. ISBN 90 6196 079 7.
- MCS 15.3 P.A. BEENTJES, K. DEKKER, P.W. HEMKER & M. VAN VELDHUIZEN, *Colloquium Stijve differentiaalvergelijkingen, deel 3*, 1975. ISBN 90 6196 118 1.
- MCS 16.1 L. GEURTS, *Cursus Programmeren, deel 1: De elementen van het programmeren*, 1973. ISBN 90 6196 080 0.
- MCS 16.2 L. GEURTS, *Cursus Programmeren, deel 2: De programmeertaal ALGOL 60*, 1973. ISBN 90 6196 087 8.
- MCS 17.1 P.S. STOBBE, *Lineaire algebra, deel 1*, 1974. ISBN 90 6196 090 8.
- MCS 17.2 P.S. STOBBE, *Lineaire algebra, deel 2*, 1974. ISBN 90 6196 091 6.
- MCS 17.3 N.M. TEMME, *Lineaire algebra, deel 3*, 1976. ISBN 90 6196 123 8.
- MCS 18 F. VAN DER BLIJ, H. FREUDENTHAL, J.J. DE IONGH, J.J. SEIDEL & A. VAN WIJNGAARDEN, *Een kwart eeuw wiskunde 1946-1971, Syllabus van de Vakantiecursus 1971*, 1974. ISBN 90 6196 092 4.
- MCS 19 A. HORDIJK, R. POTHARST & J.Th. RUNNENBURG, *Optimaal stoppen van Markovketens*, 1974. ISBN 90 6196 093 2.

- MCS 20 T.M.T. COOLEN, P.W. HEMKER, P.J. VAN DER HOUWEN & E. SLAGT, *ALGOL 60 procedures voor begin- en randwaardeproblemen*, 1976. ISBN 90 6196 094 0.
- MCS 21 J.W. DE BAKKER (red.), *Colloquium Programmacorrectheid*, 1975. ISBN 90 6196 103 3.
- MCS 22 R. HELMERS, F.H. RUYMGAART, M.C.A. VAN ZUYLEN & J. OOSTERHOFF, *Asymptotische methoden in de toetsingstheorie; Toepassingen van naburigheid*, 1976. ISBN 90 6196 104 1.
- MCS 23.1 J.W. DE ROEVER (red.), *Colloquium Onderwerpen uit de biomathe-
matica, deel 1*, 1976. ISBN 90 6196 105 x.
- MCS 23.2 J.W. DE ROEVER (red.), *Colloquium Onderwerpen uit de biomathe-
matica, deel 2*, 1976. ISBN 90 6196 115 7.
- MCS 24.1 P.J. VAN DER HOUWEN, *Numerieke integratie van differentiaalver-
gelijkingen, deel 1: Eenstapsmethoden*, 1974. ISBN 90 6196 106 8.
- MCS 25 *Colloquium Structuur van programmeertalen*, 1976. ISBN 90 6196 116 5.
- MCS 26.1 N.M. TEMME (ed.), *Nonlinear analysis, volume 1*, 1976. ISBN 90 6196 117 3.
- MCS 26.2 N.M. TEMME (ed.), *Nonlinear analysis, volume 2*, 1976. ISBN 90 6196 121 1.
- MCS 27 M. BAKKER, P.W. HEMKER, P.J. VAN DER HOUWEN, S.J. POLAK & M. VAN VELDHUIZEN, *Colloquium Discretiseringsmethoden*, 1976. ISBN 90 6196 124 6.
- MCS 28 O. DIEKMANN, N.M. TEMME (EDS), *Nonlinear Diffusion Problems*, 1976. ISBN 90 6196 126 2.
- MCS 29.1 J.C.P. BUS (red.), *Colloquium Numerieke programmatuur, deel 1A, deel 1B*, 1976. ISBN 90 6196 128 9.
- MCS 29.2 H.J.J. TE RIELE (red.), *Colloquium Numerieke programmatuur, deel 2*, 1976. ISBN 90 6196 144 0
- * MCS 30 P. GROENEBOOM, R. HELMERS, J. OOSTERHOFF & R. POTHARST, *Efficiency begrippen in de statistiek*, . ISBN 90 6196 149 1.
- MCS 31 J.H. VAN LINT (red.), *Inleiding in de coderingstheorie*, 1976. ISBN 90 6196 136 x.
- MCS 32 L. GEURTS (red.), *Colloquium Bedrijfssystemen*, 1976. ISBN 90 6196 137 8.
- MCS 33 P.J. VAN DER HOUWEN, *Differentieschema's voor de berekening van waterstanden in zeeën en rivieren*, 1977. ISBN 90 6196 138 6.
- MCS 34 J. HEMELRIJK, *Oriënterende cursus mathematische statistiek*, ISBN 90 6196 139 4.
- MCS 35 P.J.W. TEN HAGEN (red.), *Colloquium Computer Graphics*, 1977. ISBN 90 6196 142 4.
- MCS 36 J.M. AARTS, J. DE VRIES, *Colloquium Topologische Dynamische Systemen*, 1977. ISBN 90 6196 143 2.
- MCS 37 J.C. van Vliet (red.), *Colloquium Capita Datastructuren*, 1978. ISBN 90 6196 159 9.

- MCS 38.1 T.H. KOORNWINDER (ED.), *Representations of locally compact groups with applications*, 1979. ISBN 90 6196 161 0.
- MCS 38.2 T.H. KOORNWINDER (ED.), *Representations of locally compact groups with applications*, 1979. ISBN 90 6196 181 5.
- MCS 39 O.J. VRIEZE & G.L. WANROOIJ, *Colloquium Stochastische Spelen*, 1979. ISBN 90 6196 167 X.
- MCS 40 J. VAN TIEL, *Convexe Analyse*, 1979. ISBN 90 6196 187 4.
- MCS 41 H.J.J. TE RIELE (ED.), *Colloquium Numerical Treatment of Integral Equations*, 1979. ISBN 90 6196 189 0.
- MCS 42 J.C. VAN VLIET (RED.), *Colloquium Capita Implementatie van Programmeertalen*, 1980. ISBN 90 6196 191 2.
- MCS 43 A.M. COHEN & H.A. WILBRINK, *Eindige groepen (Een inleidende cursus)*, 1980. ISBN 90 6196 203 X.
- MCS 44 J.G. VERWER (ED.), *Numerical solution of partial differential equations*, 1980. ISBN 90 6196 205 6.
- MCS 45 P. KLINT (RED.), *Colloquium hogere programmeertalen en computer-architectuur*, 1980. ISBN 90 6196 206 4.
- MCS 46.1 P.M.G. APERS (RED.), *Colloquium Databankorganisatie*, 1981. ISBN 90 6196 212 9.
- MCS 46.2 P.M.G. APERS (RED.), *Colloquium Databankorganisatie*, 1981. ISBN 90 6196 232 3.
- MCS 47.1 P.W. HEMKER (ED.), *NUMAL, numerical procedures in ALGOL 60, Part I: General information and indices*, 1981. ISBN 90 6196 217 X.
- MCS 47.2 P.W. HEMKER (ED.), *NUMAL, numerical procedures in ALGOL 60, Part II: Elementary procedures, algebraic evaluations*, 1981. ISBN 90 6196 217 X.
- MCS 47.3 P.W. HEMKER (ED.), *NUMAL, numerical procedures in ALGOL 60, Part III: Linear algebra, part I*, 1981. ISBN 90 6196 217 X.
- MCS 47.4 P.W. HEMKER (ED.), *NUMAL, numerical procedures in ALGOL 60, Part IV: Linear algebra, part II*, 1981. ISBN 90 6196 217 X.
- MCS 47.5 P.W. HEMKER (ED.), *NUMAL, numerical procedures in ALGOL 60, Part V: Analytical evaluations, analytical problems, part I*, 1981. ISBN 90 6196 217 X.
- MCS 47.6 P.W. HEMKER (ED.), *NUMAL, numerical procedures in ALGOL 60, Part VI: Analytical problems, part II*, 1981. ISBN 90 6196 217 X.
- MCS 47.7 P.W. HEMKER (ED.), *NUMAL, numerical procedures in ALGOL 60, Part VII: Special functions and constants, interpolation and approximation*, 1981. ISBN 90 6196 217 X.
- MCS 48.1 P.M.B. VITANYI, J. VAN LEEUWEN & P. VAN EMBE BOAS (RED.), *Colloquium complexiteit en algoritmen, deel I*, 1982. ISBN 90 6196 237 4

De met een * gemerkte uitgaven moeten nog verschijnen.

